Stairwell Pressurization Systems

Course No: M05-022

Credit: 5 PDH

A. Bhatia



Continuing Education and Development, Inc.
9 Greyridge Farm Court
Stony Point, NY 10980

P: (877) 322-5800

F: (877) 322-4774

info@cedengineering.com

STAIRWELL PRESSURIZATION SYSTEMS

Introduction

In a high-rise building, the stairs typically represent the sole means of egress during a fire. It is imperative for the exit stairs to be free of smoke and to incorporate design features that improve the speed of occupant egress. Most building codes require the fire stairwells in a high-rise building to be pressurized to keep smoke out.



The stairwell pressurization serves several purposes:

- Inhibit migration of smoke to stairwells, areas of refuge, elevator shafts, or similar areas.
- Maintain a tenable environment in areas of refuge and means of egress during the time required for evacuation.
- Facilitate the fire and rescue operation by improving visibility in the building for the firefighting crew.
- Protect life and reduce damage to property.

The International Building Code (IBC) enforced much throughout the United States, recognizes three specific means for providing smoke proof enclosures:

1. Naturally ventilated stair balconies
2. Mechanical ventilation of a stair

3. Stair pressurization

Due to the relative cost of the associated mechanical systems, and architectural space issues related to providing exterior balconies and stair vestibules, the stair pressurization system is the most widely selected design option.

This course discusses the smoke control systems and examines the design considerations associated with stairwell pressurization systems.

Table of Contents

CHAPTER -1	7
1. REVIEW OF SMOKE	7
1.1. Hazards of Smoke	7
1.2. Smoke Management.....	7
1.2.1. Limit the fire.....	7
1.2.2. Compartmentation.....	7
1.2.3. Exhaust ventilation	7
1.2.4. Dilution	8
1.2.5. Airflow.....	8
1.2.6. Pressurization systems.....	8
1.3. Smoke Control	9
CHAPTER - 2.....	10
2. SMOKE MOVEMENT.....	10
2.1. Stack Effect.....	11
2.2. Natural Convection	12
2.3. Thermal Expansion	13
2.4. Wind forces.....	14
2.5. Buoyancy of Combustible Gas.....	15
2.6. HVAC Systems	16
CHAPTER - 3.....	18
3. SMOKE CONTROL METHODS.....	18
3.1. Pressurization Method (IBC Section 909.6)	19
3.1.1. Minimum and Maximum Pressure Requirements per NFPA 92A	20
3.1.2. Maximum Pressure Value	21
3.1.3. Door Force Calculations.....	21
3.2. Airflow Velocity Method (IBC Section 909.7).....	23
3.3. Exhaust Method (IBC Section 909.8).....	24
3.4. Performance Issues and Challenges	25
CHAPTER - 4.....	27
4. SYSTEM DESIGN.....	27
4.1. Codes and Standards	27
4.2. Pressurization Techniques.....	27

4.2.1. Non-compensated systems	28
4.2.2. Compensated systems	28
4.2.3. Single Injection Pressurization	28
4.2.4. Multiple Injection Pressurization	29
4.3. System Design and Components.....	30
4.3.1. Supply Air Fans	31
4.3.2. Fan Drive Package	32
4.3.3. Location of Fans.....	33
4.3.4. Distribution arrangements	34
4.3.5. Ductwork	35
4.3.6. Motorized Smoke & Fire Dampers (MSFD)	35
4.4. Pressure Relief Venting	35
4.4.1. Automatic Opening Door	36
4.4.2. Barometric Dampers	36
4.4.3. Motor-Operated Dampers.....	36
4.4.4. Exhaust Fan	36
4.4.5. Supply Fan Bypass	37
4.4.6. Variable Frequency Drive for the Fan.....	37
CHAPTER - 5.....	38
5. DESIGN CALCULATIONS	38
5.1. Design Criteria	38
5.2. Design Methodology	38
5.3. Air Leakage Method (ASHRAE).....	39
5.3.1. Leakage through Building Construction.....	40
5.3.2. Leakage through Door Frames.....	41
5.3.3. Leakage through Open Doors	42
5.4. Total Airflow Requirements.....	43
5.4.1. Example	44
CHAPTER - 6.....	49
6. DESIGN REQUIREMENTS.....	49
6.1. IBC Design Requirements.....	49
6.1.1. Means of Egress	50
6.1.2. Mechanical	50

6.1.3. Electrical & Controls	51
CHAPTER - 7	54
7. CONTROL SYSTEM	54
7.1. Stairwell smoke control detection and activation.....	54
7.2. Operational schedules for pressurization systems.....	55
7.2.1. Plant off except in an emergency	55
7.2.2. Plant running continuously	55
7.2.3. Plant running continuously at reduced capacity except in an emergency	
55	
7.3. Smoke Control System Equipment	56
7.3.1. Fire alarm control panel (FACP).....	56
7.3.2. Firefighter’s smoke control station (FSCS)	56
7.3.3. Response Time	58
7.3.4. Power systems	58
7.3.5. Power sources and power surges	58
7.3.6. Detection and control systems	59
7.3.7. Verification of operation equipment.....	59
7.3.8. Wiring	59
7.3.9. Emergency lighting	59
CHAPTER - 8	60
8. STAIRWELL PRESSURIZATION ACCEPTANCE TESTING.....	60
8.1. General conditions of testing.....	60
8.1.1. Pre-functional checklist	60
8.2. Sequence of operation	61
8.3. Activation of the system	62
8.4. Pressure differential	62
8.5. Air velocity.....	62
8.6. Door opening force	63
8.7. Alarm system test	63
8.8. Qualifications	63
8.9. Reports	63
8.10. Documentation.....	64
8.10.1. Detailed Design Report.....	64

8.10.2. Operations and Maintenance Manual	65
Summary	66
References	66

CHAPTER -1

1. REVIEW OF SMOKE

1.1. Hazards of Smoke

- Smoke contains toxic and irritant gases.
- $\frac{3}{4}$ of all fire deaths are caused by smoke inhalation.
- Approximately 57% of fire deaths occur outside the room of fire origin.
- 47% of fire survivors could not see more than 12'.
- Smoke travels 120 to 240 ft./min.

1.2. Smoke Management

A smoke management system includes all methods described below singly or in combination to modify or influence the smoke movement.

1.2.1. Limit the fire

An important consideration when designing a smoke control system is to ensure that evacuation is faster than the spread of smoke/fire. Controlling fire size, typically by means of hosepipes, hydrants and sprinklers should be a part of the overall smoke management program. An automatic fire suppression system would be expected to limit the heat release rate and control the spread of fire.

1.2.2. Compartmentation

Compartmentation involves use of barriers with sufficient fire endurance to prevent spread of smoke to spaces remote from the fire. The method employs walls, partitions, floors, doors, smoke barriers, smoke dampers, and other fixed and mechanical barriers. The effectiveness of compartmentation is limited by the extent to which the free leakage paths are controlled through the barriers. Smoke control system designers often use the compartmentation method in combination with the pressurization method.

1.2.3. Exhaust ventilation

Smoke control in large open areas with high ceilings such as atria, shopping malls, concourse, airports, etc. is best achieved by exhaust ventilation. Hot smoke is

collected at the high level in a space, where it is vented outside by means of a powered smoke exhausting fan. Make-up supply air below the smoke layer is also crucial, and is provided from the adjacent spaces free of smoke.

1.2.4. Dilution

The dilution method clears smoke from spaces remote from a fire. The method supplies outside air through the HVAC system to dilute smoke. Using this method helps to maintain acceptable gas and particulate concentrations in compartments subject to smoke infiltration from adjacent compartments. In addition, the fire emergency service can employ the dilution method to remove smoke after extinguishing a fire. Smoke dilution is also called smoke purging, smoke removal, or smoke extraction.

The approach may be used, for example, to clear smoke that has infiltrated a protected space such as an escape corridor or refuge lobby. Also dilution can be beneficial to the fire service for removing smoke after a fire has been extinguished.

1.2.5. Airflow

The airflow method controls smoke in spaces that have barriers with one or more large openings. It is used to manage smoke through open doorways, subway, railroad, and highway tunnels. The method employs air velocity across or between barriers to control smoke movement. A disadvantage of the airflow method is that it supplies increased oxygen to a fire. Within buildings, the airflow method must be used with great caution. The airflow method is best applied after fire suppression or in buildings with restricted fuel.

1.2.6. Pressurization systems

The method employs a pressure difference across a barrier to control smoke movement. The pressurization systems are installed mainly in the stairwells, elevator shafts, refuge spaces and other egress routes. The high-pressure side of the barrier is either the refuge area or an exit route. The low-pressure side is exposed to smoke. Airflow from the high-pressure side to the low-pressure side (through construction cracks and gaps around doors) prevents smoke infiltration. A path that channels smoke from the low-pressure side to the outside ensures that gas expansion

pressures do not become a problem. A top-vented elevator shaft or a fan-powered exhaust can provide the path. In contrast to exhaust ventilation and dilution systems, the pressurization systems are designed to protect zones away from the fire source.

Important

Smoke management systems are designed to modify, dilute, redirect, or otherwise influence the movement of smoke in a building experiencing a fire, but not necessarily to control it or limit its movement. The mechanisms of compartmentation, dilution, airflow, pressurization, and buoyancy are used singly or in combination to manage smoke conditions in fire situations.

1.3. Smoke Control

Smoke control systems are intended to limit and control the movement of smoke during a fire. The most common approach involves using pressure differences on either side of the boundaries of the fire area. The example is stairwell pressurization system. Typically the pressure differentials are created by actively controlling dedicated mechanical fans and dampers (if applicable) to supply the stairwell with 100% outdoor air.

The design requirements are discussed in subsequent sections.

CHAPTER - 2

2. SMOKE MOVEMENT

A building can be considered as a series of spaces each at a specific pressure with air movement between them from areas of high pressure to areas of low pressure. While in practice, it is possible for pressure gradients to exist in large vertical spaces such as stairwells, the significant pressure differences can generally be considered as occurring across the major separations of the building structure, i.e. doors, windows, walls and floors. The difference in pressure determines whether it will flow at all, and how much and how quickly it will flow. Large pressure differences produce large flows. The principal factors responsible for the pressure differences and, therefore, the smoke movement are:

1. Differences in temperature between outdoor and indoor air (stack effect)
2. Natural convection
3. Thermal expansion
4. Wind forces
5. Buoyancy of combustion gases
6. HVAC operation

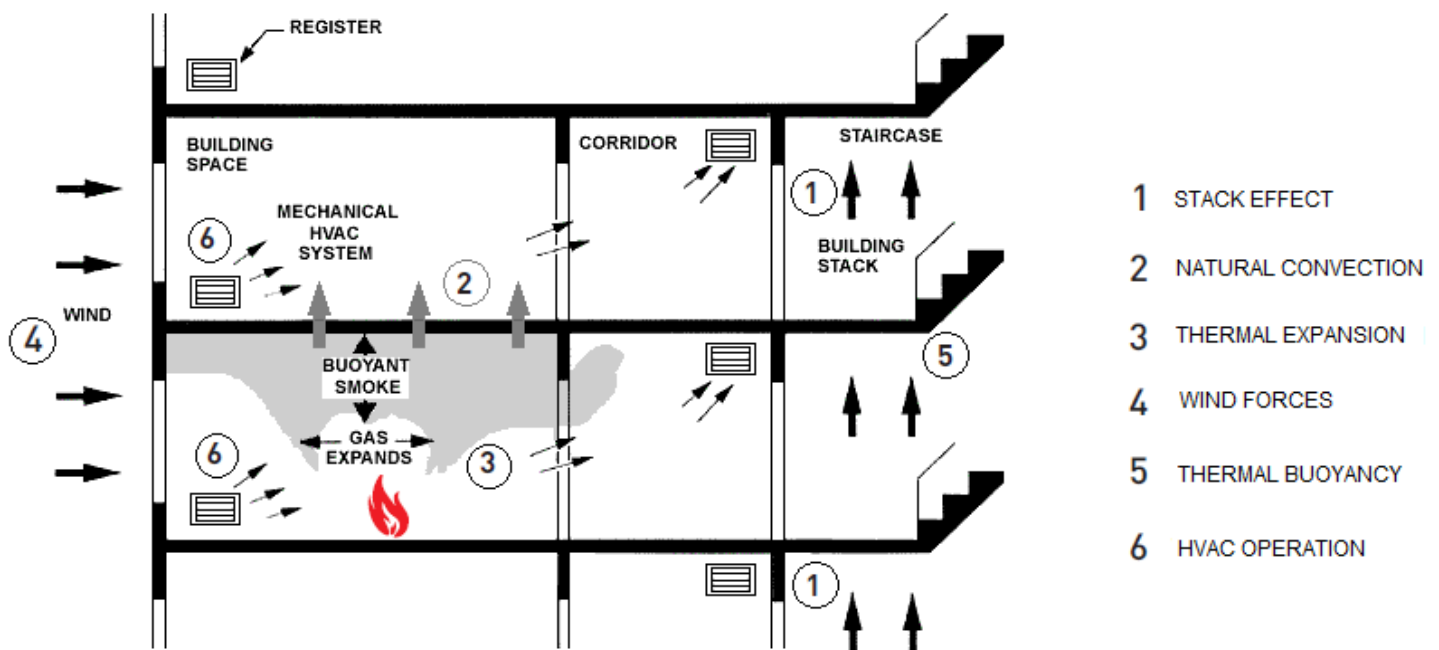

FACTORS AFFECTING THE MOVEMENT OF SMOKE

2.1. Stack Effect

Stack effect is a result of different air densities inside and out of a building that cause the pressure distribution of air in a building to be different from that outdoors.

If the airflow is from bottom to upwards, it is normal stack effect. It happens in winters when the less dense warmer air (indoor) rises and cold outside air rushes in to take its place. The reverse happens in summers when the cooler air inside the building sinks and draws warmer outside air in through the top of the building.

The stack effect is more pronounced in the winter. When it's cold outside, the stack effect creates about 4 pascals of pressure for every floor of the building. In the summer, this drops to 1.5 pascals per floor.

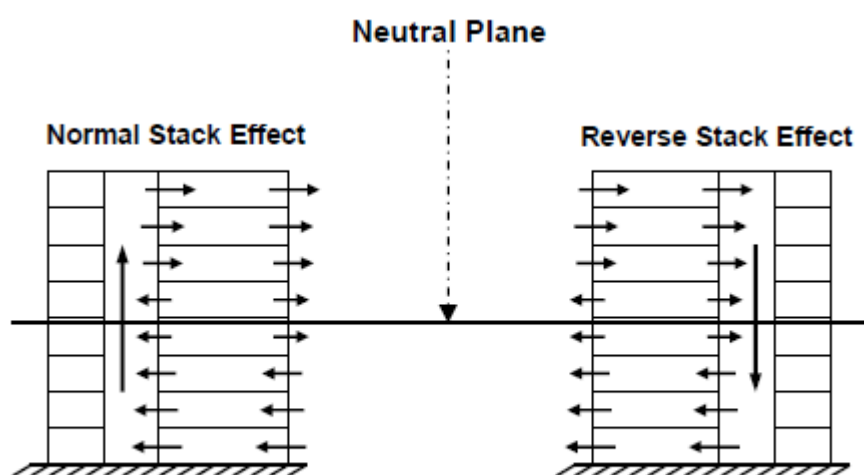

Air Movement Due to Normal and Reverse Stack Effect

At standard atmospheric pressure, the pressure difference due to normal or reverse stack effect is expressed as:

$$\Delta P = K_s \times \left(\frac{1}{T_o} - \frac{1}{T_i} \right) \times h$$

Where

- ΔP = Pressure difference inches of water
- K_s = Coefficient, 7.64
- T_o = Absolute temperature of outside air, °R
- T_i = Absolute temperature of the air inside the shaft, °R

- h = Distance above neutral plane, ft.

At some intermediate point between top and bottom, the pressure is neutral and is called the neutral pressure plane. The height of the "neutral plane is determined by the relative leakage areas of the buildings structure at high and low levels. Generally the neutral plane is at or near mid-height. It is possible to shift the neutral plane close to the position of the opening by providing sufficiently large openings at the top or bottom of a building.

This is the underlying principle behind natural venting to control smoke movement. Assuming winter conditions, the pressure at the top will be lesser than the lower floors. It will result in infiltration of air at each floor level. In the event of fire, the shaft will be filled with smoke, which can be dangerous for people escaping the building. This situation can be averted by pressurizing the stairwell.

Stack effect will be significant in very tall buildings. Table 1 below shows the impact the height can have on stack effect induced pressure differentials, given a constant temperature differential.

Table 1: Impact of Building Height on Stack Pressure Differentials

Building Height	Outside Temp [°F]	Inside Temp [°F]	ΔP [in. w.c.]
75 ft.	0	70	0.08
300 ft.	0	70	0.33
984 ft.	0	70	0.54
2133 ft.	0	70	0.72

2.2. Natural Convection

Natural or free convection results from temperature differences within a fluid. As a fluid is heated, it expands while mass remains the same. Decreased density (mass/unit volume) makes the heated fluid more buoyant, causing it to rise. As the heated fluid rises, cooler fluid flows in to replace it. Natural convection is one of the major mechanisms of heat transfer in a compartment fire, heated air and smoke rise,

and cooler air moves in to replace it. This process transfers thermal energy, thereby heating other materials in the compartment, and also transfers mass as smoke moves out of the compartment, and cool air (containing oxygen necessary for continued combustion) moves into the compartment.

2.3. Thermal Expansion

As the temperature within a fire compartment rises, the gases expand in direct proportion to their absolute temperature. Two to three volumes of hot gases may be displaced from the zone depending on the maximum temperature attained by the fire. The volumetric flow of smoke out of a fire zone is greater than the airflow into the fire zone. This situation is expressed as:

$$\frac{Q_{out}}{Q_{in}} = \frac{T_{out}}{T_{in}}$$

Where:

- Q_{out} = Volumetric flow rate of smoke out of the fire compartment, cfm
- Q_{in} = Volumetric flow rate of air into the fire compartment, cfm
- T_{out} = Absolute temperature of smoke leaving the fire compartment, Rankine (R)
- T_{in} = Absolute temperature of air into the fire compartment, Rankine (R)

Venting or relieving of pressures created by expansion is critical to smoke control.

The relationship between volumetric airflow (smoke) and pressure through small openings, such as cracks, is as:

$$\Delta P = \left(\frac{Q}{K_f A} \right)^2$$

Where,

- ΔP = Pressure drop across the flow path, in wc.
- Q = Volumetric flow rate, cfm
- K_f = Coefficient, 2610
- A = Flow area, sq. ft

2.4. Wind forces

Wind velocity can have a significant effect on the movement of smoke within a building. The pressure distribution on the surface of a building due to wind is far from uniform and depends on the direction of wind, shape and height of building, shielding effects of local obstructions to flow. The pressure distribution is conveniently expressed as:

$$P_w = C_w \times K_w \times v^2$$

Where:

- P_w = Wind pressure, in. wc
- C_w = Dimensionless pressure coefficient
- K_w = Coefficient, 4.82×10^{-4}
- v = Wind velocity, mph

The coefficient, C_w , values range from -0.8 to 0.8, with positive values for windward walls and negative values for leeward walls.

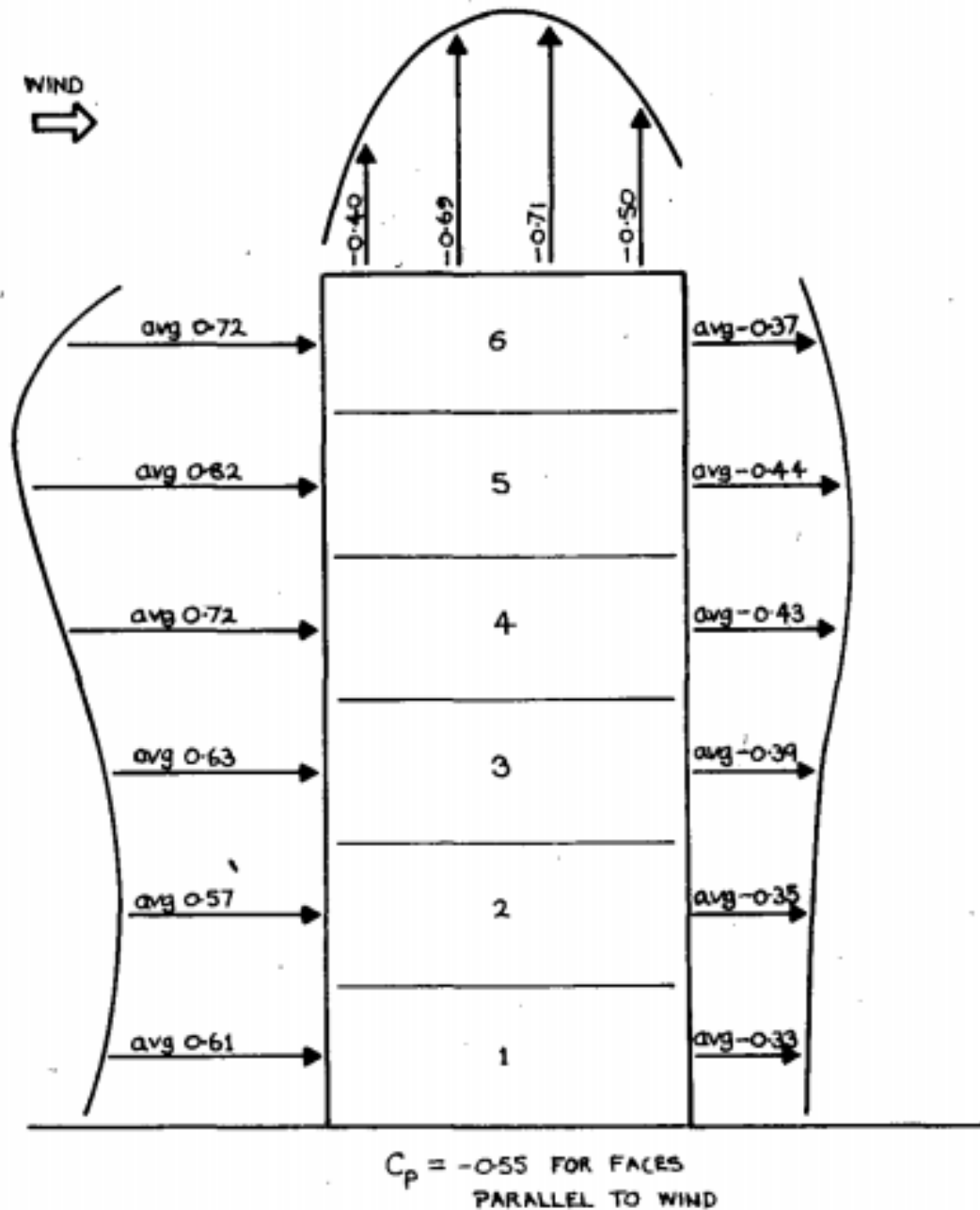

The higher the wind velocity, the greater the pressure on the side of the building. A 35 mph wind produces a pressure on a structure of 0.47 in. w.g with a pressure coefficient of 0.8.

2.5. Buoyancy of Combustible Gas

Hot gases produced during the fire have a lower density and, therefore, rises upwards due to the thermal buoyancy force. However, as smoke moves away from

the fire, its temperature is lowered due to dilution; therefore, the effect of buoyancy decreases with distance from the fire.

The pressure difference between a fire zone and the zone above can be expressed as:

$$\Delta P = K_s \times \left(\frac{1}{T_o} - \frac{1}{T_f} \right) \times h$$

Where:

- ΔP = Pressure difference, in- wc.
- K_s = Coefficient, 7.64
- T_o = Absolute temperature of surrounding air, Rankine (R)
- T_f = Absolute temperature of the fire compartment, Rankine (R)
- h = Distance from the neutral plane, ft.

2.6. HVAC Systems

Air movement produced by mechanical ventilation sets up pressure differences in a building in a similar manner to and superimposed on those due to natural forces.

By design, the heating, ventilation and air conditioning (HVAC) systems typically supply air at a higher rate than is extracted (or the reverse may occur in certain applications). It is becoming more common for buildings to be pressurized, i.e. at a positive pressure with respect to external conditions, particularly with the increasing use of sealed windows. This has the advantage of limiting air infiltration caused by wind and stack effects. HVAC equipment with certain enhancements and interlocking with fire and smoke detection systems can fulfill the duty of smoke control.

Summarizing:

All the above factors create pressure differences across barriers (e.g., walls, doors, floors) that result in the spread of smoke. It is necessary to consider the effect of each or a combination to assess the requirements for an economical pressurization system. The fire officer can determine for himself which of the pressure differences is the most dominant.

- A factor of particular importance is stack effect especially in high-rise buildings. The stack effect phenomenon is visible 24 hours and even small ambient temperature changes may cause substantial pressure gradients in a very short time.
- The wind can have a very large effect on the spread of fire gases especially in certain geographic locations or at high elevations or not so tight buildings.
- If the fire is very intense and the temperature in the fire room and even other adjoining rooms is very high, the pressure differences resulting from the thermal buoyancy force, or the thermal expansion, can be the most dominant.
- The dominating pressure difference can also vary during the course of the fire. In the initial stage of a fire, or during small fires, it can be the HVAC system that has the greatest effect on the spread of fire gases in the fire zone. At a later stage, the same HVAC system can also contribute to the spread of fire gases to other building zones resulting in a fully developed fire.

The primary means of controlling smoke movement is by developing higher pressures in the areas to be protected and in the building (zones) adjacent to the compartment of fire origin.

CHAPTER - 3

3. SMOKE CONTROL METHODS

We learned in the previous section the factors responsible for smoke movement. In this section we will discuss smoke control methods.

The primary means of controlling smoke movement is by actively manipulating the pressure conditions in a way that fire gases are made to flow out from the building and prevent entry into the confined space. The work methods, the choice of them, and the tactical structure of the fire and rescue operation depend on the objective and purpose of the measures.

Before we proceed, let's define three important terms first:

1. **High-Rise Building:** According to NFPA 101, Life Safety Code; "Any building greater than 75 feet in height, measured from the ground level access to the highest floor level intended for occupant use" is categorized as a high-rise building. International Building Code (IBC) Section 403 also has a similar definition.
2. **Smoke Refuge Area:** An area of the building separated from other spaces by fire resistant rated smoke barriers, in which a tenable environment is maintained for the period of time that such areas might be occupied at the time of fire.
3. **Tenable Environment:** An environment in which smoke and heat are limited or otherwise restricted to maintain the impact on occupants to a level that is not life threatening. The principle objective of a smoke control system is to maintain a tenable environment longer than the required safe egress time.

Smoke control methods are often defined as active or passive systems.

- **An active smoke control system** uses mechanical equipment to control the spread of smoke in a structure. It includes pressurization method, airflow method and exhaust method.
- A **passive smoke control system** uses building construction materials to limit the spread of smoke in a structure. Typical passive smoke control systems include compartmentation, fire rated walls, barriers, smoke vents, shafts etc.

The International Building Code (IBC) allows three active smoke control methods to contain smoke:

1. Pressurization Method (IBC Section 909.6)
2. Airflow Design Method (IBC Section 909.7)
3. Exhaust Method (IBC Section 909.8)

3.1. Pressurization Method (IBC Section 909.6)

Pressurization systems use mechanical fans to produce a positive pressure on the stairwells. The two key pressurization principles are maintaining:

1. A pressure difference across a barrier
2. Average velocity of sufficient magnitude.

Consider an example of a stairwell “A” maintained at a positive pressure relative to lift lobby “B” which is at a higher pressure relative to the fire zone corridor space “C”. Each of the three zones A, B and C are separated by the partition barriers and the doors. The lobby and stairwell (marked green) can be classified as escape routes, refuge area and tenable environment. These invariably repeat themselves at the same position at each floor level for at least a number of successive floors.

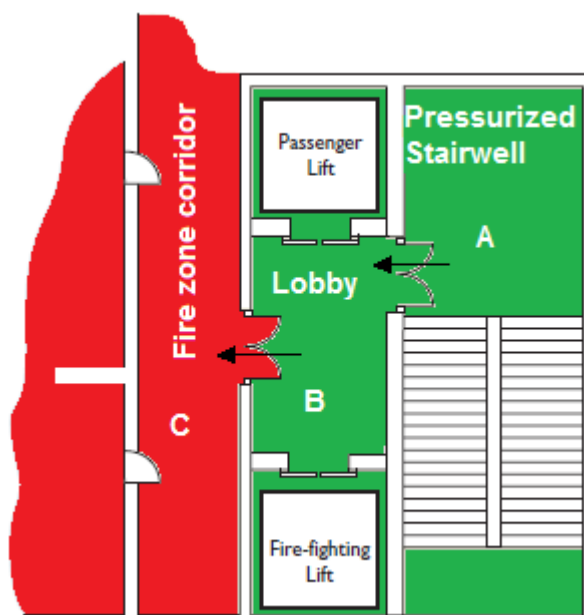

We learned that air flows from the higher pressure area to the lower pressure area. The principle of maintaining a tenable environment is to prevent migration of smoke laden air from zone “C” to zone “B” and to zone “A”. This is achieved by pressurizing

the stairwell and lobby such that the pressure in zone A is greater than the pressure in zone B, which in turn is maintained greater than zone C. Two scenarios exist:

1. **Door closed** - When the lobby doors are closed, an overpressure of the elevator lobby with respect to the building will prevent smoke infiltration from the building spaces into the lobby. An excess pressure must be maintained in zones A and B so that flow is always outwards, preventing the entry of smoke from zone C.

Caution - The pressure should not be so high that it prevents the door opening. A right balance of minimum and maximum pressure difference must be maintained.

2. **Door open** - When the doors are opened during evacuation, the gaps get much wider and the pressure tends to equalize between two zones. A good pressurization system design must maintain minimum pressures and respond quickly to stair door openings. Studies indicate that the smoke tends to be held back by the outflow of air if the egress velocity from pressurized spaces is sufficiently high. An egress velocity of 200 fpm (~1 m/s) is recommended.

3.1.1. Minimum and Maximum Pressure Requirements per NFPA 92A

NFPA 92, 2012, Table 5.2.1.1 (shown as Table 2 below) lists the recommended pressure differences between the smoke zone and adjacent spaces under close doors conditions.

Table 2 - Suggested Min. Design Pressure Differences across Smoke Barriers

Building Type	Ceiling Height		Design Pressure Difference	
Sprinklered	Any Height		0.05 in. H ₂ O	12.4 Pa
Not-sprinklered	9 ft.	2.7 m	0.10 in. H ₂ O	24.9 Pa
Not-sprinklered	15 ft.	4.6 m	0.14 in. H ₂ O	34.8 Pa
Not-sprinklered	21 ft.	6.4 m	0.18 in. H ₂ O	44.8 Pa

Conversion units, 1 ft. = 0.305 m; 0.1 in. H₂O = ~25 Pa.

As you can see in Table 2 above, the minimum pressure requirement in a fully sprinklered building is 0.05 inch water gauge. This is because temperatures are not expected to increase beyond 200°F due to cooling and lesser likelihood of smoke generation.

3.1.2. Maximum Pressure Value

The maximum pressure allowed in the stairwell is limited by the force required to open the door from the floor to the stairwell. Studies indicate that the pressure over 0.35 inch water gauge can do more harm than good because unreasonably high door-opening forces can make it difficult or impossible for occupants to open doors to refuge areas or escape routes. The worst case would be for an occupant who would otherwise be able to safely exit via the stairwell be stuck in fire zone due to overpressure conditions in the stairwell.

3.1.3. Door Force Calculations

The door opening depends on:

1. The person's strength;
2. The location of the door knob;
3. The coefficient of friction between floor and shoe; and
4. Whether, the door requires a push or pull.

For a hinged, swinging door in motion, when the force is applied at the knob, the door opening force can be determined from the equation below for different door widths:

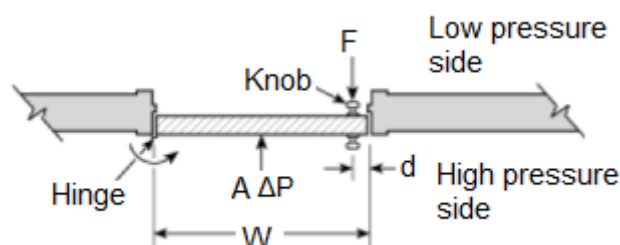

$$F = F_d + \frac{5.2 (WA) \Delta P}{2 (W - d)}$$

Where,

- F = Maximum allowable door opening force (usually 30 pounds to allow children and elderly occupants to exit)
- F_d = Force required to overcome the self-closing mechanism (lbf)
- W = Door width (ft.)
- A = Door area (ft²)
- ΔP = Pressure difference across the door (in- w.g.)
- d = Distance from the doorknob to the knob side of the door (ft.)

Section 5-2.1.1 of the NFPA 101, Life Safety Code requires the door opening force in egress path to be limited to no more than 30 lbf (133N).

Empirically, the equation above yields the values, indicated in Table 3 below, for the maximum pressure design differences across different door widths.

Table 3: Maximum Pressure [in.H₂O (Pa)] across Different Doors Widths:

Force to overcome the door closer	32" (0.81m) Door	36" (0.91m) Door	40" (1.02m) Door	44" (1.12m) Door	48" (1.22m) Door
6 lb. (25 N)	0.45 (113)	0.40 (102)	0.37 (92)	0.34 (84)	0.31 (78)
8 lb. (35 N)	0.41 (103)	0.37 (93)	0.34 (83)	0.31 (77)	0.28 (71)
10 lb. (45 N)	0.37 (92)	0.34 (83)	0.30 (75)	0.28 (69)	0.26 (64)
12 lb. (55 N)	0.34 (82)	0.30 (74)	0.27 (66)	0.25 (61)	0.23 (56)
14 lb. (65 N)	0.30 (71)	0.27 (64)	0.24 (58)	0.22 (53)	0.21 (49)

Notes:

Table 3 assumes the following:

- Total door opening force is 133N (30lb).
- Door height is 7 ft. The distance from the doorknob to the knob side of the door is 3 inches.

- c. Doors are hinged at one side.

How to read Table 3:

Example: When the maximum door opening force is considered to be 133N (30 lb.) and the force to overcome the door closer is 27N (6 lb.), a hinged door 36" x 7 ft. high would have a maximum allowable pressure difference of 0.40 in H₂O.

Summarizing:

Stairwells shall be pressurized to maintain 0.10 inch water gauge (25 Pa) to 0.35 inch water gauge (88 Pa) across any (closed) stairwell door when used in conjunction with an automatic sprinkler system. The minimum pressure differences are imposed to prevent smoke from entering the shaft. Where the system designer has determined that a higher minimum pressure difference is necessary to achieve the smoke control system objectives, the higher minimum pressure difference shall be used.

The maximum pressure difference is also specified to maintain proper door functioning. The recommended value is around 0.45 inch water gauge and is derived from the maximum allowable door opening force allowed for doors entering the stairs, which is typically specified to be 30 lb.

3.2. Airflow Velocity Method (IBC Section 909.7)

The airflow design method is typically used where large openings are created, for example, due to opening of doors across a fire barrier. It is difficult to sustain design pressures in such scenarios and under such situations; smoke will find its way to the refuge areas or escape routes.

Airflow method employs air velocity to control smoke movement. The minimum average velocity through a fixed opening is estimated as:

$$v = 217.2 [h (T_f - T_o) / (T_f + 460)]^{1/2}$$

Where:

- h = Height of opening, feet
- T_f = Temperature of smoke, °F
- T_o = Temperature of ambient air, °F

- v = Air velocity, feet per minute (fpm)

Caution

A disadvantage of the airflow method is that it supplies large quantities of air which may unduly intensify the fire, disrupt plume dynamics or interfere with exiting systems. Therefore, airflow velocity towards the fire should NOT exceed 200 fpm. Where the equation above yields values over this limit, the airflow method shall not be used.

A multi-level enclosed parking garage with openings at each level is an example of a place where an Airflow Design Method should be utilized.

3.3. Exhaust Method (IBC Section 909.8)

The exhaust method is generally utilized in large open spaces, such as covered malls and atriums. It provides negative pressure in the spaces through exhaust fans, and the design intent is to maintain the layer of smoke at least 10 feet above any walking surface. Airflow is calculated on the volume of the space and the make-up air fans supply outside air typically at 80% of the calculated volume of the exhaust.

This method is unlike the pressurization system, which provides a slightly higher pressure in the escape routes such as stairwell. A comparison is tabulated below:

Exhaust Systems	Pressurization Systems
<p>Goal: Removal of smoke and fire gases produced during the fire out of the building</p>	<p>Goal: Protecting escape routes against smoke and fire gases infiltration by achieving fixed value of overpressure in reference to fire zone.</p>
<p>Application: Low and medium-rise buildings certain tall buildings.</p>	<p>Application: All categories of multi-story buildings with allocated zones of safe evacuation.</p>
<p>Evacuation Possibilities: None or substantial hindering of safe evacuation.</p>	<p>Evacuation Possibilities: Protecting escape routes, safe evacuation via pressurized escape routes enabled.</p>

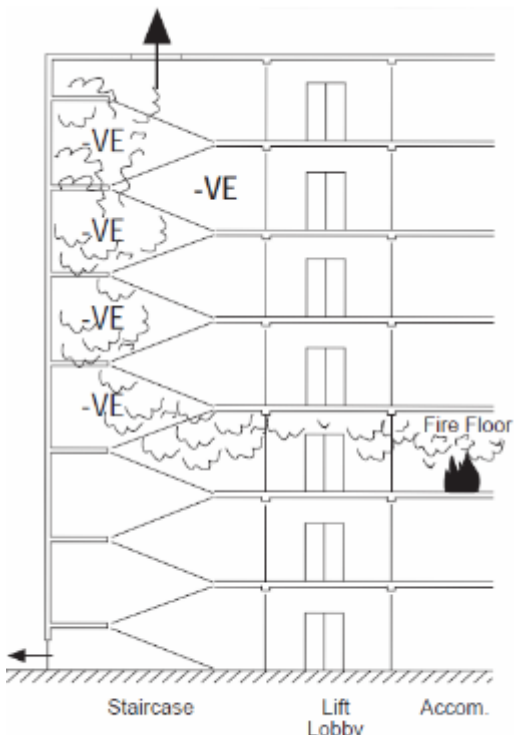
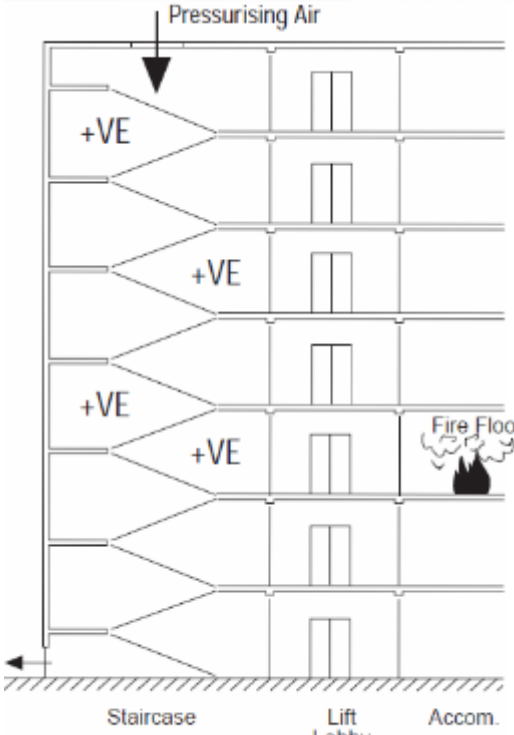
<p>Rescue and Fire action Performance:</p> <p>Enabling firefighting access below the fire source</p>	<p>Rescue and Fire action Performance:</p> <p>Enabling firefighting access below the fire source and rescue action at floors over fire source.</p> <p>Additionally manually triggered smoke extraction from pressurized space.</p>
 <p>The diagram shows a cross-section of a building with a fire on the 'Fire Floor'. Smoke is shown rising from the fire and being drawn into a staircase shaft. Arrows indicate smoke being pulled into the shaft from the fire floor and then being exhausted out of the top of the shaft. The areas below the fire floor are labeled '-VE', indicating negative pressure. The staircase is labeled 'Staircase', the area below it 'Lift Lobby', and the area below that 'Accom.'. The title below the diagram is 'Smoke Control by Extraction'.</p>	 <p>The diagram shows a cross-section of a building with a fire on the 'Fire Floor'. Pressurising air is shown entering the staircase shaft from the top. Arrows indicate air being pushed into the shaft from the top and then into the staircase. The areas above the fire floor are labeled '+VE', indicating positive pressure. The staircase is labeled 'Staircase', the area below it 'Lift Lobby', and the area below that 'Accom.'. The title below the diagram is 'Smoke Control by Pressurization'.</p>

3.4. Performance Issues and Challenges

The design of stairwell pressurization systems gets complicated with regards to three scenarios:

1. *Stack effect* - Pressure stabilization is difficult to achieve in high-rise buildings. The phenomenon is more pronounced in tall buildings and in locations where there is wide variations in ambient temperatures. Designing a pressurized stairwell system especially in cold climate requires designer to consider the variables of temperature, wind and construction standards. Tight stairwell construction helps reduce the stack effect.

2. *Inadequate vents* - Satisfactory pressurization of a stairwell could be difficult during all closed door conditions and a building with inadequate vents.
3. *Evacuation time* - Intermittent loss of effective pressurization occurs when occupants enter and leave stairs during evacuation. The exterior stairwell door is the greatest cause of pressure fluctuation and it is important to conservatively take into account the number of doors that may be open simultaneously during an emergency. This number will depend largely on the building occupancy.

The high-rise building pressurization design becomes more complex and often requires additional analysis which may be performed with the use of analytical calculations, zone-models or CFD simulations that confirm effectiveness of selected solution.

CHAPTER - 4

4. SYSTEM DESIGN

The stairwell pressurization system is a mechanical ventilation system. In order to pressurize the stairs of vertical buildings, it is necessary to install sets of fans that suck air into the stairwell, keeping pressure of 0.10 – 0.45 inch water gauge. The main purpose is to prevent infiltration of smoke in the event of a fire.

The system consists of the installation of a fan with an electric motor mounted in an isolated compartment. The outside air is captured through a shutter that has a particle filter. The excess air is relieved through manual and automatic dampers properly calculated and installed at the suitable locations.

4.1. Codes and Standards

The following codes and standards are commonly used:

- International Building Code (IBC), 2003: Section 909
- NFPA 101 – Life Safety Code
- NFPA 92A – Recommended Practice for Smoke Control Systems
- NFPA 92B – Guide for Smoke Management in Malls, Atria, and Large Areas
- NFPA 90 - Standard for Installation of Air-conditioning and Ventilating system.
- ASHRAE 1999 HVAC Applications, Chapter 52, Fire and Smoke Management
- ASHRAE Principals of Smoke Management Handbook
- British Standard BS5588 - Smoke Control in Protected Escape Route using Pressurization.
- British Standard BS 5720 - Code of Practice for Mechanical Ventilation and Air Conditioning in Buildings

4.2. Pressurization Techniques

Stairwell smoke control employs one or more of these design techniques:

1. Non-compensated pressurization
2. Compensated pressurization
3. Single injection pressurization

4. Multiple injection pressurization

4.2.1. Non-compensated systems

A non-compensated system provides a constant volume of air by a single-speed fan. The level of pressurization depends on the number of doors open. When access doors open, the pressure in the stairwell drops. When access doors close, the pressure rises. Non-compensated stairwell pressurization is reasonably well when:

- Stairwells are in a lightly populated building (for example: luxury apartments).
- Stairwell access doors are usually closed, but when used, remain open only for a few seconds.

4.2.2. Compensated systems

A compensated system adjusts to any combination of door openings by maintaining a positive pressure differential across the openings. Systems compensate for changing conditions by either modulating air flow or relieving excess pressure from the stairwell. A compensated pressurization system will have more components (sensors, relief dampers, VFDs, etc.) and control sequences.

4.2.3. Single Injection Pressurization

A single injection system uses pressurization air at one location. While the strategy is simple, a single injection system can fail if a stairwell access door opens near the injection point. Loss of pressurization air will occur immediately at the access doors farther from the injection point. The most common injection point is at the top of the building.

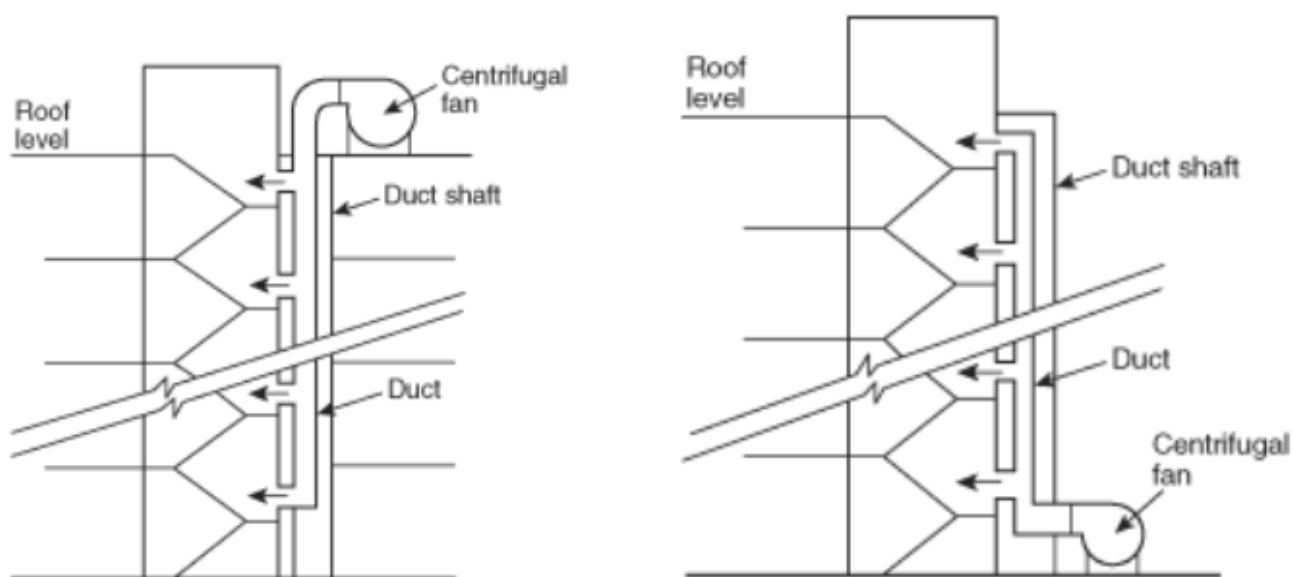

Top Injection	Bottom Injection
Fan at top of stair	Fan at bottom of stair
Security of air is concern	Security less issue
Smoke recirculation	No smoke re-circulation
Minimal footprint	Takes up valuable real-estate
Higher pressure at top of stair	Lower pressure at top of stair
Lower pressure at bottom	Higher pressure at bottom

4.2.4. Multiple Injection Pressurization

The multiple injection technique supplies air from more than one location. The scheme may use multiple fans or a single fan connected to a ducted arrangement with multiple outlets. How far apart these air injection points should be located is dependent on the height of the building, and most guidelines suggest locating them at 3 to 5 floors apart.

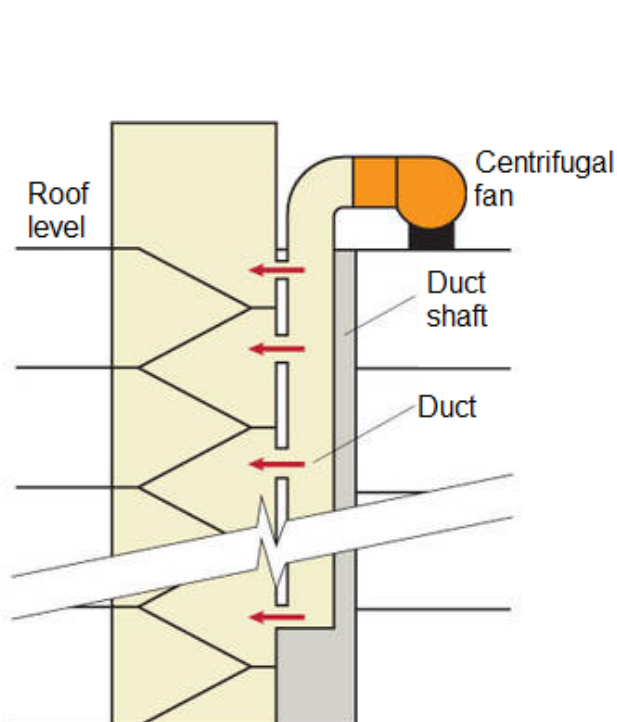

Multiple Injection Pressurization System

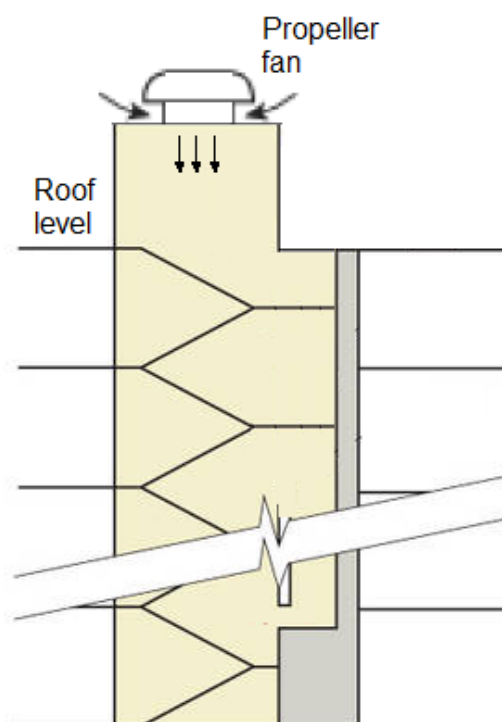

Single Injection Pressurization System

4.3. System Design and Components

A pressurization system consists of two main components:

1. Supply air (where air is injected into the area that is to be protected)
2. Relief air (to avoid overpressure when doors are closed)

The System comprises:

1. Supply fans for introducing air.
2. Distribution systems comprising ducting, terminal diffusers and venting arrangements.
3. Automatic air release vents/dampers to release excess air and avoid over pressurization when doors are closed.
4. Automatic control system comprising fire alarms, smoke detectors, safety switches and devices at locations to suit fire service.

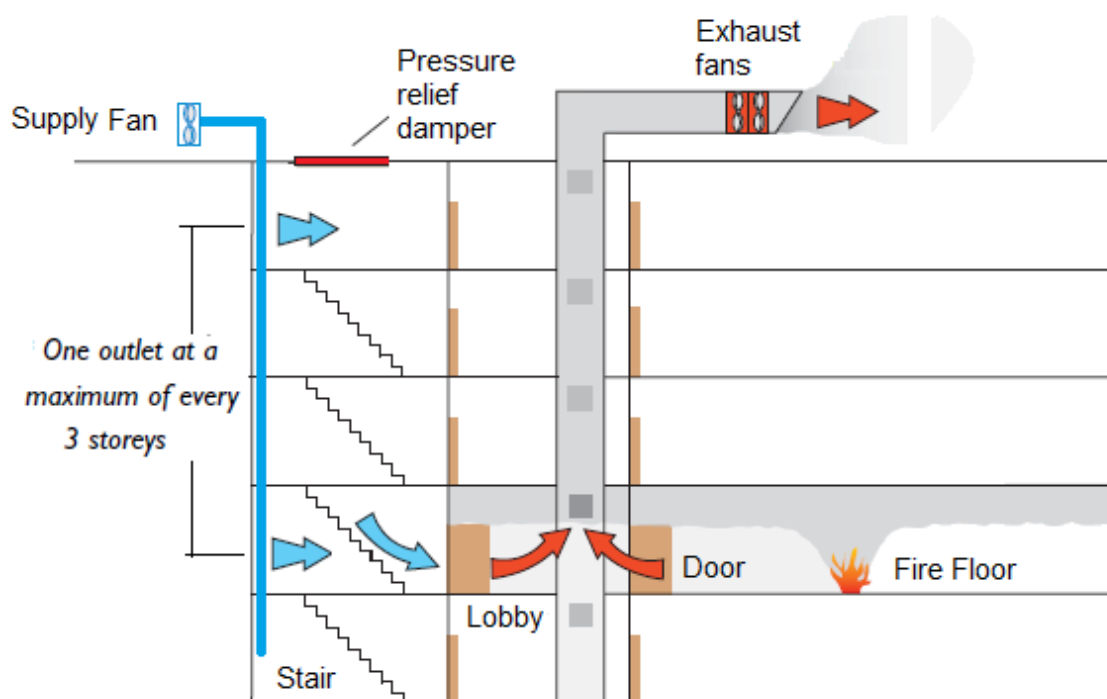

4.3.1. Supply Air Fans

Supply air fans for pressurization are either the centrifugal or axial type. Centrifugal fans generate airflow in a radial direction to the impeller. Axial fans on the other hand, generate airflows parallel to the impeller. Both centrifugal and axial fans can provide adequate capacity and static pressure to overcome the resistance. Axial in-line fans are often preferred because:

- They have a relatively flat pressure curve with respect to varying flow. Therefore, as doors are opened and closed, the axial fans quickly respond to airflow changes without major pressure fluctuations.
- They are usually less costly and have lower installed costs.

The drawback is that they are readily affected by wind pressure on the building. These often require windshields at the air intake, especially when they are wall-mounted. This is less critical when axial fans are mounted on roofs because they are often protected by parapets and the direction of the wind is at right angles to the axis of the fan.



Centrifugal Fan



Axial Fan

The pressurization fan may be activated manually or automatically by means of a fire detection system. An additional manual switch at the entrance gate of the building and on the electric fan panel may be required by many state codes. Check with applicable design standards and/or codes enforced by the authority having jurisdiction (AHJ).

4.3.2. Fan Drive Package

The International Building Code (IBC) requires fans used for smoke control purposes:

- a. To operate at or below their rated horsepower and to be selected with a minimum service factor of 1.15.
- b. To have 1.5 times the number of belts required for design duty, and no fewer than two.
- c. To be designed to run in a stable portion of the fan curve. All fans have performance curves based on the airflow being provided and the static pressure present.
- d. To have an adequate capacity to deliver performance while operating in a stable portion of the fan curve.
- e. To operate at elevated temperatures.

4.3.3. Location of Fans

The stairwell pressurization fan can be located anywhere, but since the entry/exit doors at ground level will remain open during emergency for fire personnel entry as well refuge escape operations, the top location is preferred to avoid the short-circuiting of the air.

Fans shall be positioned to avoid introducing smoke and toxic gases into the stair especially when located at high level.

- There should be two air intakes facing different directions in order not to be affected by the same source of smoke.
- Each air intake shall be protected by a smoke control damper operated independently via a smoke detector in such a way that if one damper closes due to smoke contamination, the other air intake will supply the air requirements of the system without interruption.
- The air intakes should be ducted to the fan inlet. This measure is necessary to prevent the pressurization fan reducing the pressure in the plant room below atmospheric pressure and hence inducing flow from the building towards the plant room.
- Each inlet shall be independently capable of providing the full air requirements of the system.
- The air intake shall not be less than 5m horizontally from any exhaust discharge opening and be independent from wind speed and direction.

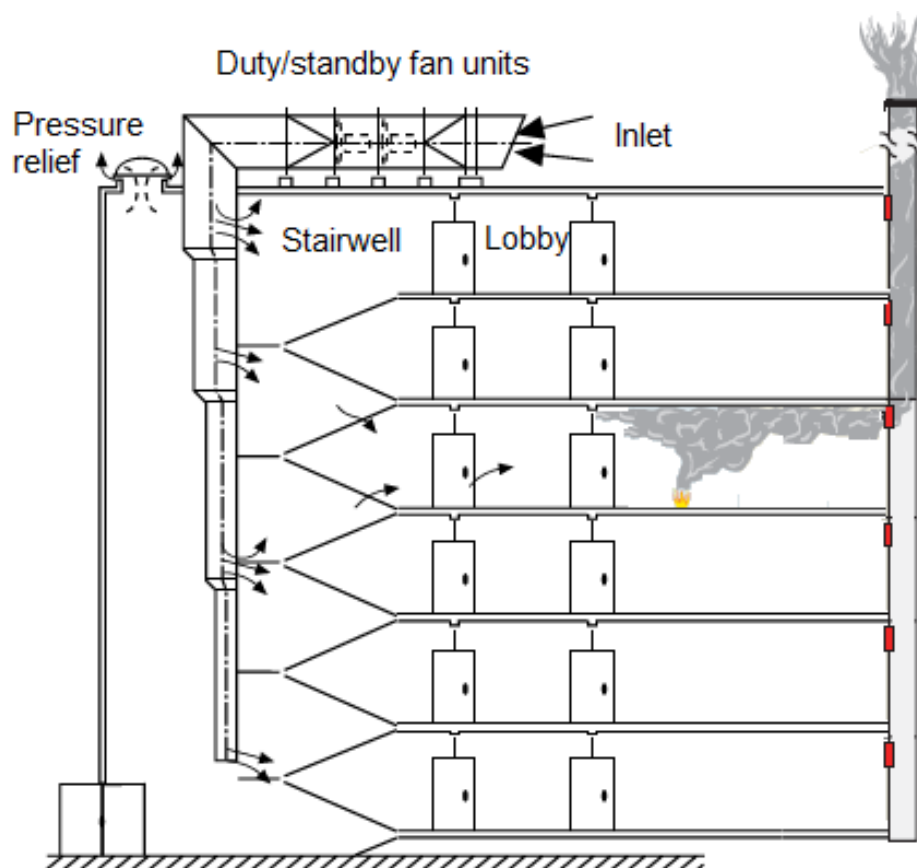

Stairwell Pressurization System with Pressurization Air and Smoke Exhaust

Note: According to NFPA 92A, smoke detectors at the fan inlet are necessary to shut down the fan and close the inlet damper to prevent recirculation of smoke.

4.3.4. Distribution arrangements

For high-rise buildings the preferred distribution arrangement is a vertical duct running adjacent to the pressurized spaces. Distributing to these areas can be achieved by:

- a. A single fan serving a vertical duct with short horizontal branches to each floor.
- b. Multiple plants serving multiple floors.

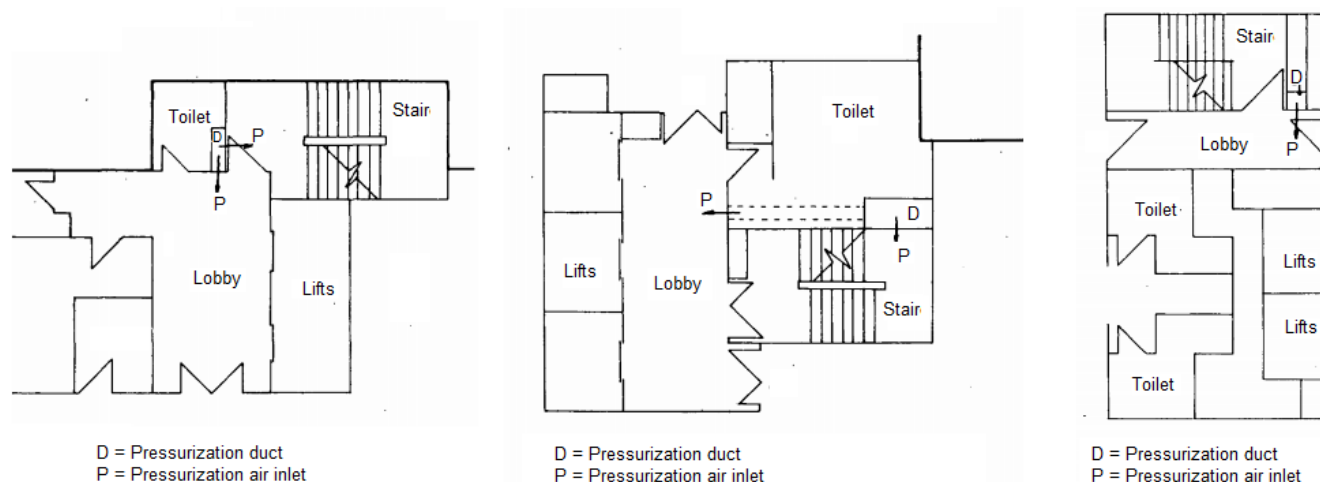

TYPICAL SERVICE CORE GENERAL ARRANGEMENTS

4.3.5. Ductwork

There is no real difference between supply air ductwork used for comfort HVAC and the pressurization air systems. The pressurization air can be delivered either from a dedicated galvanized duct work or a masonry shaft. Experience indicates that without sealing and internal lining of the surfaces, the masonry ducts have excessive friction loss and 20 to 50% air leakage.

4.3.6. Motorized Smoke & Fire Dampers (MSFD)

Dampers for smoke control systems are required to meet UL 555S. This is consistent with those requirements found in NFPA 92. The IBC further regulates the type of smoke damper to be used. IBC requires:

- Smoke dampers to have leakage ratings no less than Class II and elevated temperature ratings of not less than 250°F. This limits the allowable leakage from the damper at the higher temperature expected in the system.
- The operating temperature shall be at least 50°F (10°C) above the maximum smoke control temperature or a maximum of 350°F (177°C). This is to ensure the damper will not close prematurely when the system is operating in the smoke control mode.

4.4. Pressure Relief Venting

Stairwell pressurization systems are accompanied with a vent system. The purpose of the vent is to relieve excess pressures in the stair when doors are opened and

closed. When a door is opened, the pressure in the stair is reduced and the relief vent closes, thereby diverting the excess air to the open door. When the door closes, the vent serves as a relief for excess pressures in the stair to reduce door-opening forces. One of the following methods may be adopted to relieve excess air:

4.4.1. Automatic Opening Door

This is the simplest form of control. It uses electric unlocking of door in the event of high pressure in the stairwell. Under normal conditions, the exterior stairwell door would normally be locked for security reasons and open on fan activation.

4.4.2. Barometric Dampers

Barometric dampers use adjustable counterweights which are adjusted so that the damper opens when a particular (excessive) pressure is reached. The location of dampers needs to be carefully chosen since dampers located too close to the supply openings can operate too quickly.

4.4.3. Motor-Operated Dampers

Motor-operated dampers use signals from a differential pressure sensor to actuate. These dampers may have pneumatic or electric motor actuators triggered by the pressure differential between the stair and floors served by the stair.

4.4.4. Exhaust Fan

An exhaust fan can be used to relieve excess pressure. The operation of fan is triggered by signals from a differential pressure sensor. The fan will shut off when the pressure difference falls below a specified level.

The figure below illustrates various air relief concepts:

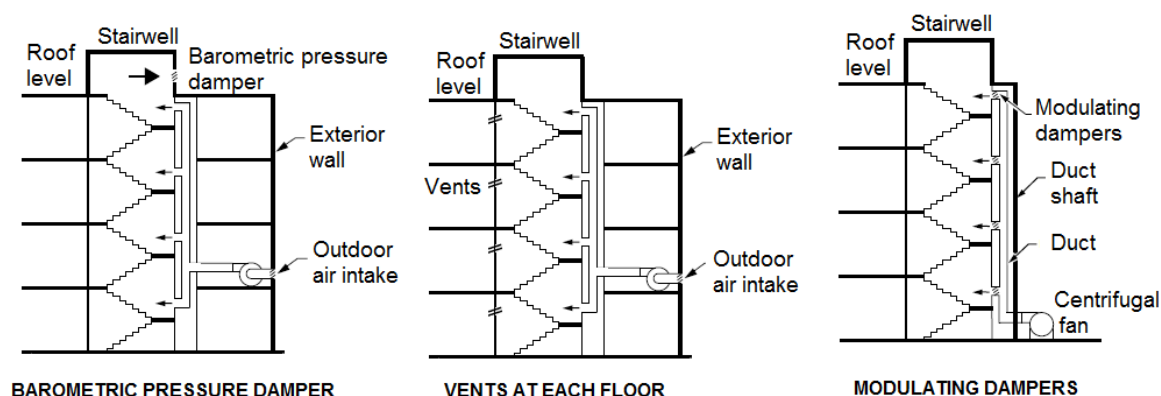

4.4.5. Supply Fan Bypass

When all the stairwell doors are closed, the pressure difference increases and the bypass damper opens in response to differential pressure readings, thereby increasing the bypass air and decreasing the supply air to the stairwell.

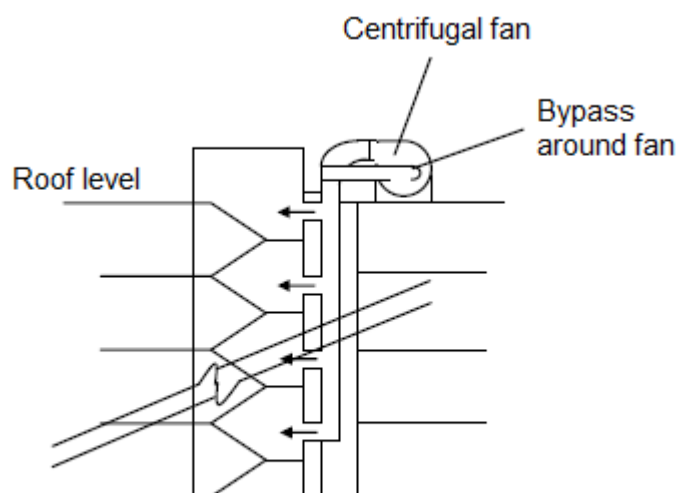

**Stairwell Pressurization with Bypass
Around Supply Fan**

4.4.6. Variable Frequency Drive for the Fan

The variable frequency drive (VFD) is becoming increasingly popular in modern pressurization systems. VFD allows the fan speed (RPM) to be altered thereby modulating the airflow. The control signal is obtained from a pressure sensor controller that senses the static differential pressure between the stairwell and the occupied zone and gives feedback for corrective action.

CHAPTER - 5

5. DESIGN CALCULATIONS

This section deals with the design criteria and methodology for calculating the air flow rates and venting requirements for pressurization systems.

5.1. Design Criteria

The Staircase Pressurization calculation is usually based on the following design criteria:

- a. $\Delta p_{\min.}$ = min. pressure difference = 0.18 in wg between staircase and adjacent accommodation space (NFPA 92A, Table 5.2.1.1).
- b. $\Delta p_{\max.}$ = max. pressure difference = 0.37 in wg between staircase and adjacent accommodation space (IBC 2006, Section 909.7.2).
- c. Airflow velocity of not greater than 200 fpm (~1 m/s) through doors when 3 doors are open (IBC 909. 7.2).
- d. Maximum Force required to open any door at the door handle shall not exceed 30 lbs (133 N).

5.2. Design Methodology

In the straightforward case of a lobby or staircase, the air flow rate is simply determined by the sum of leakage allowances at the desired pressurization.

1. Identify all the airflow paths with doors closed and calculate the leakage rate via these airflow paths (construction cracks in walls and floors).
2. Identify all the airflow paths with doors closed and calculate the leakage rate via the gaps around the doors.
3. Calculate the air supply required with all the doors closed with a 50% increase for unknown.
4. Identify all the different doors and calculate the air supply required through these doors with $v= 200$ fpm and an allowance of 15% for ductwork losses.
5. Calculate the total airflow (all doors closed + 3 doors open) and determine the fan duty point.
6. Check that the door opening forces are below 30 lbs

7. Calculate the size of the pressure relief damper.

5.3. Air Leakage Method (ASHRAE)

Air flows from high pressure to low pressure through leakage paths, and the amount of air moving will depend on the resistance offered by the separations. In practice the separations are doors and windows, and the leakage paths are the gaps around these. Leakage flow can also occur through floor and wall construction where these are of a pervious nature. To pressurize a particular zone in a building to a specified level by means of mechanical ventilation, the rate of input air is determined by the resistance of the leakage paths. Therefore, analyzing the behavior of these leakage paths is the prime requirement for estimating the capacity of pressurization systems for buildings.

Chapter 26 of the 2001 ASHRAE Fundamentals Handbook provides the following equation that correlates air leakage to the differential pressure producing the flow.

$$Q = K * (N * A/\rho^{1/2}) * (\Delta p_{\max}^{3/2} - \Delta p_{\min}^{3/2}) / (\Delta p_{\max} - \Delta p_{\min})$$

Where,

- Q = airflow leakage rate, CFM
- K = constant = 475
- N = number of floors of injection point
- A = flow area between stairwell and building
- ρ = density of air in stairwell = 0.075 lb/ft³
- Δp_{\min} = min. pressure difference = 0.18 in wg (NFPA 92A, Table 5.2.1.1)
- Δp_{\max} = max. pressure difference = 0.37 in wg (IBC 2006, Section 909.7.2)

Simplified Equation:

A simplified relationship between Space Differential Pressure, Room Leakage Area, and the Airflow can be found using the Equation 4.8a - from ASHRAE Design of Smoke Management Systems, page 42.

$$(IP) Q = 2610 A (\Delta P)^{1/2}$$

Where,

- Q is the airflow leakage in CFM
- A is the total leakage area Square Feet
- ΔP is the differential pressure Inches of H₂O

$$\text{(SI) } Q = 840 A (\Delta P)^{1/2}$$

Where,

- Q is the airflow leakage in Liters per Second (lps)
- A is the total leakage area in Square Meters
- ΔP is the differential pressure in Pascals

5.3.1. Leakage through Building Construction

Each gap and crack in the building envelope contributes a certain amount of area to the total leakage area of the building. While the flow area of most large openings can be calculated easily, the flow area of construction cracks is dependent on workmanship. If the construction is of concrete, it will probably be satisfactorily leak-proof. But if the construction is of block/brick work, it will probably need to be plastered to make it leak proof. As a rule of thumb, stairwell walls can be expected to have construction cracks of $0.11 \times 10^{-3} \text{ ft}^2$ in area for every one square-foot of wall area.

Typical leakage areas of construction cracks in walls and floors of commercial buildings are listed in NFPA 92, 2012, Table A.4.6.1. The extract is indicated in Table 4 below:

Construction Element	Tightness	Area Ratio ^a
Exterior building walls (includes construction cracks and cracks around windows and doors)	Tight ^b	0.50×10^{-4}
	Average ^b	0.17×10^{-3}
	Loose ^b	0.35×10^{-3}
	Very loose ^b	0.12×10^{-2}
Stairwell walls (includes construction cracks, but not cracks around windows and doors)	Tight ^c	0.14×10^{-4}
	Average ^c	0.11×10^{-3}
	Loose ^c	0.35×10^{-3}
Elevator shaft walls (includes construction cracks, but not cracks and gaps around doors)	Tight ^c	0.18×10^{-3}
	Average ^c	0.84×10^{-3}
	Loose ^c	0.18×10^{-2}
Floors (includes construction cracks and gaps around penetrations)	Tight ^d	0.66×10^{-5}
	Average ^e	0.52×10^{-4}
	Loose ^d	0.17×10^{-3}

^a For a wall, the area ratio is the area of the leakage through the wall divided by the total wall area. For a floor, the area ratio is the area of the leakage through the floor divided by the total area of the floor.

^b Values based on measurements of Tamura and Shaw (1976), Tamura and Wilson (1966) and Shaw, Reardon, and Cheung (1993).

^c Values based on measurements of Tamura and Wilson (1966), and Tamura and Shaw (1976).

^d Values extrapolated from average floor tightness based on range of tightness of other construction elements.

^e Values based on measurements of Tamura and Shaw (1978).

Source: NFPA 92, 2012, Table A.4.6.1.

Table 4: Typical Leakage Areas in Walls and Floors

Note: Table 4 above does not include openings between door and frame, frame and sill, window glazing etc. This has to be estimated separately.

5.3.2. Leakage through Door Frames

The amount of air leakage around the door/window gaps can then be estimated from the following equation:

$$Q = 2610 * A * (\Delta P)^{1/2}$$

The effective leakage areas (A) can be estimated by using the values in Table 5 below:

Table 5: Typical Leakage Areas around Doors

Type of Door	Size	Crack Length	Gap	Leakage Area across closed door (crack length x gap) = (ft ²)
Single leaf in frame	3 ft. x 7 ft.	20 ft.	0.006	0.12
Double leaf	6 ft. x 7 ft.	33 ft.	0.006	0.20

5.3.3. Leakage through Open Doors

When a door is in open position, no appreciable room differential pressure can be sustained and there will be significant air leakage. The flow rate through an open door can be calculated using equation:

$$Q = V_{\max} \times A_{\text{door}}$$

Where,

- Q = flow rate through one open door, cfm
- V_{\max} = max. air velocity through an open door = 200 fpm (IBC 909. 7.2)
- A_E = effective opening of door

For a single door of 3' x 7', the effective opening, $A_E = \sim 0.12$ square feet.

For several openings, two scenarios exist: doors in parallel and doors in series.

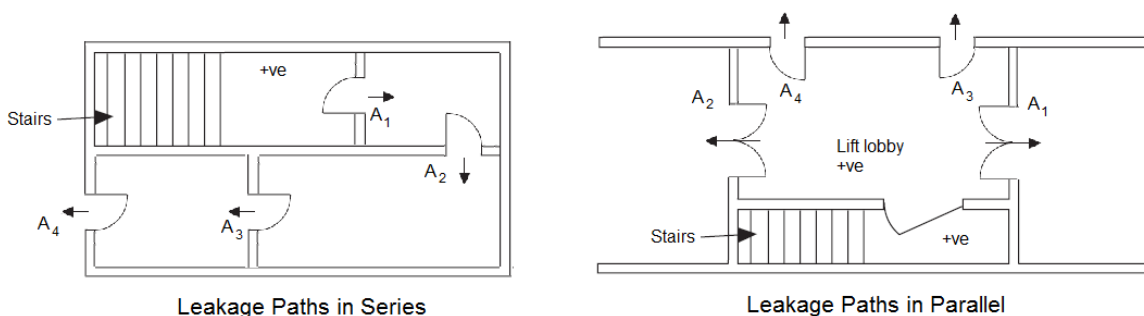

For doors situated in **parallel** around a pressurized space, the effective leakage area is:

$$A_E = A_1 + A_2 + A_3 + A_4...$$

For doors situated in series along an escape route, the effective leakage area is:

$$A_E = \left[\frac{1}{(A_1)^2} + \frac{1}{(A_2)^2} + \frac{1}{(A_3)^2} + \frac{1}{(A_4)^2} + \dots \right]^{-\frac{1}{2}}$$

For design purposes, three (3) doors in open position are assumed.

5.4. Total Airflow Requirements

Total airflow through the stairwell is given as:

$$\begin{aligned} Q_T \text{ (Total Airflow)} \\ &= \\ Q_1 \text{ (Leakage through gaps in building construction)} \\ &+ \\ Q_2 \text{ (Leakage around door gaps)} \\ &+ \\ Q_3 \text{ (assuming 3 open doors at a time)} \end{aligned}$$

OR

$$\begin{aligned} Q_T \text{ (Total Airflow)} \\ &= \\ Q_1 &= 2610 \times A \text{ (Leakage)} \times (\Delta P)^{\frac{1}{2}} \dots\dots \text{Use Table 4 for Leakage Area, "A"} \\ &+ \\ Q_2 &= 2610 \times A \text{ (Leakage)} \times (\Delta P)^{\frac{1}{2}} \dots\dots \text{Use Table 5 for Leakage Area, "A"} \\ &+ \\ Q_3 &= A \times V \dots\dots (3 \text{ doors open}) \end{aligned}$$

Where,

- A = Flow area, ft²
- ΔP = Pressure difference, inches water
- V = Air velocity across open door, fpm

5.4.1. Example

Estimate the pressurization requirements for an office stairwell that runs 5 floor levels. Each floor level has a height of 17 ft. and is 28 ft. (W) x 48 ft. (L). It has 2 single leaf egress doors of 3' x 7' and one double leaf egress door of 6' x 7'. Assume 3 doors are open and the maximum differential pressure to be maintained between the stairwell and the office is 0.037 in. H₂O.

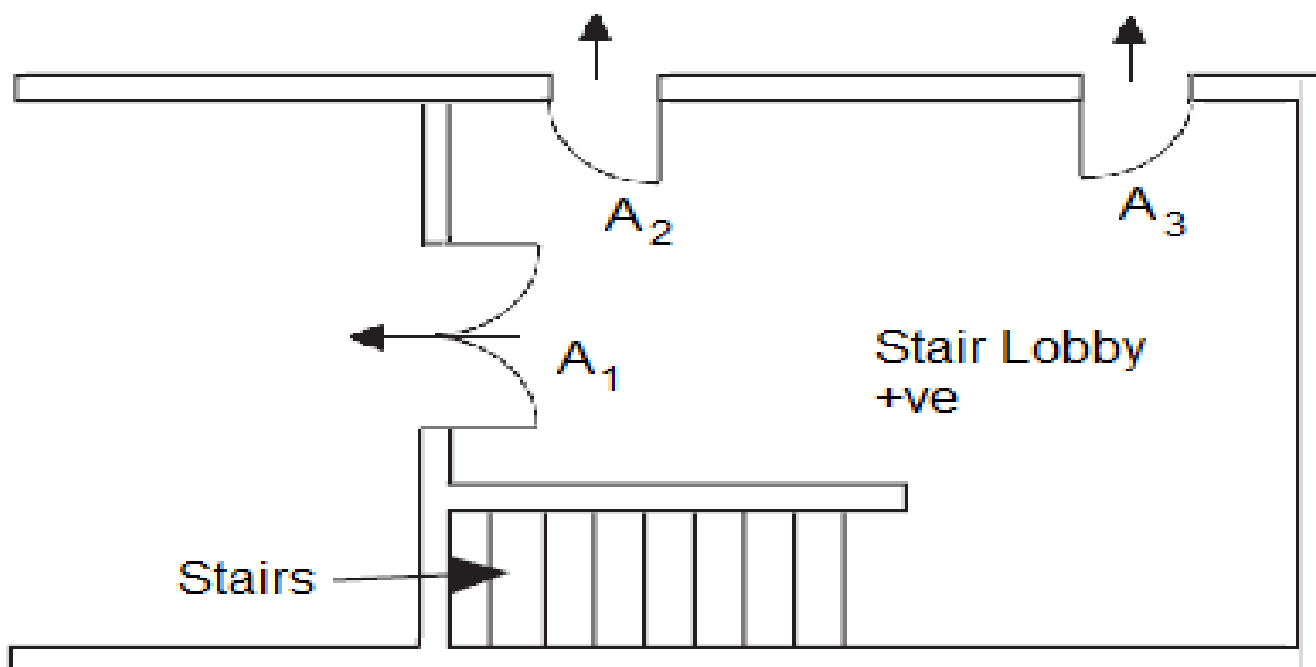

Solution

Structural component	Height (ft.)	Length (ft.)	Width (ft.)	Area Calculations	Average Leakage Ratio A_L/A	Total leakage area (ft ²)
Walls	17	48	28	Perimeter: = 2 x (28 + 48) = 152 ft. Area (A): = 152 x 17 = 2584 ft ²	0.11×10^{-3}	= 0.11×10^{-3} x 2584 = 0.28
Floor	-	48	28	Area (A): = 28 x 48 = 1344 ft ²	0.52×10^{-4}	= 0.52×10^{-4} x 2688 = 0.14
Ceiling	-	48	28	Area (A): = 28 x 48 = 1344 ft ²	0.52×10^{-4}	= 0.52×10^{-4} x 2688 = 0.14
Door frame (A ₁)	7		6	Gap length: 7+7+7+6+6 = 33 ft.	Door crackage: = 0.006	= 33 x 0.006 = 0.20
Door frames (A ₂ and A ₃)	7		3	Gap length: 7+7+3+3 = 20 ft.	Door crackage: = 0.006	= 20 x 0.006 = 0.12 per door For 2 doors = 0.24

Total Leakage Area/floor						<p>= 0.28 + 0.14 + 0.14 + 0.20 + 0.24 = 1 sq. ft.</p>
--------------------------	--	--	--	--	--	--

Air flow through gaps in building construction, (Q_1) + Air flow around door gaps (Q_2) is represented by the following equation:

$$Q_{(1+2)} = K_f * A_L * (\Delta P)^{1/2}$$

Where,

- Q = Flow Rate (cfm)
- K_f = Coefficient, 2610
- A = Flow Area, 1 ft²
- ΔP = Pressure Diff., 0.37 in-H₂O

Or

Volumetric Flow Rate: $Q_{(1+2)} = 2610 * 1 * (0.37)^{1/2}$

$Q_{(1+2)} = 1587$ cfm/floor

Number of floors of stairwell = 5

Therefore, the total volumetric flow rate = 1587 x 5 = 7935 cfm

Air Flow through Open Doors (Q_3)

Effective open area across doors

- A_1 = area of door = 5' x 7' = 35 ft²
- A_2 = area of door = 3' x 7' = 21 ft²
- A_3 = area of door = 3' x 7' = 21 ft²

For doors situated in parallel around a pressurized space, the effective leakage area is:

$$A_E = A_1 + A_2 + A_3$$

$$A_E = 35 + 21 + 21 = 77 \text{ ft}^2$$

The flow rate through the open doors, cfm

$$Q_3 = V_{\max} \times A_E$$

Where, V_{\max} is the maximum air velocity considered through an open door and is 200 fpm (IBC 909. 7.2)

Therefore,

$$Q_3 = 200 \times 77 = 15,400 \text{ cfm}$$

Total Air for Pressurization (Q_T)

Q_T (Total Airflow) = Leakage through gaps in building construction + Leakage around door gaps + Leakage through open doors

$$Q_T \text{ (Total Airflow)} = Q_{(1+2)} + Q_3 \text{ (open doors)}$$

$$Q_T \text{ (Total Airflow)} = 7935 + 15400 = 23335 \text{ cfm (say 24000 cfm)}$$

Determine Fan Duty Point

The fan should be selected for the total air required for pressurization, and the total pressure against which the fan has to work is the summation of resistance of air distribution system and emergency pressurization level.

The required fan duty shall be assessed from the following:

- Volume flow rate = Aggregated supply to all pressurized areas + 10% safety margin
- Fan total pressure = Total resistance of distribution system
- Fan static pressure = Fan total pressure - velocity head at fan discharge

Supply Outlets

In the above example, consider air distribution at 5 levels giving approximately 4800 cfm at each supply outlet.

The supply outlet grill should be sized for low velocity of about 500 to 600 feet per minute (fpm) giving the grille area of $4800/600 = 8$ sq. ft. or 4' x 2'.

Venting Requirements

Fresh air introduced into the building must escape to prevent excess pressures.

The excess airflow to be relieved is determined by subtracting the air leakage under all doors closed condition (Q_{1+2}) from the airflow required with doors open (Q_3). So in our example:

Total required airflow with 3 doors open = 15,400 cfm

Total air leakage from stairwell envelope = 7935 cfm

Relief air requirements = $15400 - 7935 = 7465$ cfm

The pressure relief damper shall be able to maintain at or above the design pressurization level but below the maximum pressure determined by the door opening force requirements. The exhaust relief vent (with dampers) can be sized at a high velocity up to 2000 fpm and shall be adjusted to maintain +0.10 inch water gauge (25 Pa) pressure in the stair shaft. The exhaust grille area will therefore be $7465 \text{ cfm} / 2000 \text{ fpm} = 3.7$ sq. ft.

CHAPTER - 6

6. DESIGN REQUIREMENTS

6.1. IBC Design Requirements

1. Sections 909.5 through 909.9 of International Building Code (IBC) provide the design criteria which must be utilized when designing the Smoke Control System. These sections of the code are pertinent to the Fire Protection Engineer or Mechanical Engineer of Record.
2. Section 909.10 discusses the requirements of the fans, ducts, automatic dampers, etc. used for Smoke Control Systems.
3. Section 909.11 requires two sources of power to all components associated with the smoke control system and the requirement for all equipment associated with the smoke management system relying on volatile memory to be equipped with a UPS.
4. Section 909.12 discusses the requirements for the fire alarm detection and control equipment.
5. Section 909.14 requires all junction boxes, access panels and terminations used for smoke control systems and detection devices to be clearly marked.
6. Section 909.15 requires "Control Diagrams" to be kept on file with the building department, fire department and fire command center. Control Diagrams identify all devices associated with the smoke control system(s) and identify their operation when smoke control is initiated.
7. Section 909.18 discusses the requirements of acceptance testing of the smoke control system.
8. Section 909.19 states that a certificate of occupancy cannot be obtained until the smoke control systems has proven to be fully functional in accordance with the provisions of section 909, and the fire department has received instructions on the operation of the system. This section allows for temporary certificate of occupancy for phased construction, provided the occupied portion of the building complies with the provisions of this section and the remaining portion does not pose a hazard to the occupants.

9. Section 909.20 through 909.20.6.2 discusses the design principles for smoke proof enclosures.

6.1.1. Means of Egress

1. Exit stairs must be constructed as smoke proof enclosures [IBC 403.13] or pressurized in compliance with [IBC Section 909]
2. Doors from the building to the smoke proof enclosure's vestibule must be 1½-hour fire rated. [IBC 1020.1.7 and NFPA 101 7.2.3.4]
3. Doors from the smoke proof enclosure's vestibule to the stairway must be not less than 20-minute fire rated. [IBC 909.20.4.1 and 909.20.3.2]
4. Stairway doors, which can be locked, must be provided with automatic electrical unlocking from the central station.
5. Telephones or other two-way communication systems must be provided at not less than every fifth floor inside the stairwell. [IBC 403.12 and 403.12.1]
6. One stair must extend to the roof and must be marked at street and floor levels with a sign indicating that it continues to the roof. [IBC 1009.11]
7. Appropriate signage must be provided at each floor, five feet above the landing that is visible when the door is opened or closed. The sign must indicate the floor level, the terminus of the top and bottom of the stair enclosure, and the identification of the stair. [NFPA 101 7.2.2.5.4]

6.1.2. Mechanical

1. Smoke Control Equipment (IBC requirements)
 - Fans (IBC 909.10.1)
 - Ducts (IBC 909.10.2)
 - Dampers (IBC 716.3 and 716.5.5)
2. Stairwell Pressurization Fans:
 - a. The IBC lists physical building height criteria for determining when stairwell pressurization fan system is required.

- b. The buildings over 7 stories should be evaluated for two fans for pressurization, with one fan at the top of the stairwell and the other fan to be located near the bottom of stairwell.
 - c. The fan shall be variable volume using a VFD and shall maintain positive static pressure in each stairwell. The differential pressure across the stairwell access the door shall not exceed the maximum opening force as specified in the latest edition of NFPA 92A.
3. Stair pressurization systems must be independent of other building ventilation systems. [IBC Section 909.20.6]
4. Equipment and ductwork for stair pressurization must be located in accordance with NFPA 101 7.2.3.9.2
5. All equipment used for pressurization system including, but not limited to, fans, ducts, automatic dampers and balance dampers, shall be suitable for its intended use, suitable for the probable exposure temperatures that the rational analysis indicates and as approved by the fire code official.
 - Smoke Dampers- ANSI/UL 555S, Standard for Smoke Dampers
 - Smoke Control Systems – ANSI/UL 864 Standard for Control Units
 - Materials – NFPA 90A

6.1.3. Electrical & Controls

1. Power and Control Equipment (IBC requirements)
 - Power systems (IBC 909.11)
 - Detection and Control Systems (IBC 909.12)
 - Firefighters Control Panel (IBC 909.16)
2. The electric service installation shall be in accordance with NFPA 70. Emergency standby power loads must be connected to the emergency generator and must be operational within 60 seconds [IBC 403.10.2].
3. A Fire Command Center complying with IBC Section 911.1 shall be provided in a location approved by the fire department and shall contain the following features:

- a. The emergency voice/alarm communication system unit.
 - b. The fire department communications unit.
 - c. Fire detection and alarm system annunciator unit.
 - d. Elevator floor location and operation annunciator.
 - e. Sprinkler valve and water flow display panels.
 - f. Emergency generator supervision devices, manual start and transfer features.
 - g. Controls for unlocking stairway doors simultaneously.
 - h. Telephone for fire department use with controlled access to the public telephone system.
 - i. Fire pumps status indicators.
 - j. Status indicators and controls for air-handling systems.
 - k. The fire fighters control panel required by IBC Section 909.16 for smoke control systems.
 - l. Emergency power and standby power status indicators.
 - m. Schematic building plans indicating the typical floor plan and detailing the building core, means of egress, fire protection systems, fire-fighting equipment and fire department access.
 - n. Worktable.
 - o. Public address system, where specifically required by other sections of this code.
4. Emergency power must be available within 10 seconds to operate the following (IBC 403.11.1):
- a. Emergency voice/alarm communication systems
 - b. Fire alarm systems
 - c. Automatic fire detection systems
 - d. Elevator car lighting

- e. Escape route lighting
 - f. Exit sign illumination
5. An emergency voice/alarm communication system, which is also allowed to serve as a public address system, shall be installed in accordance with IBC 907.2.12.and 403.6.
 6. The voice alarm system must provide a predetermined message to the area where the alarm originated or actuated by a smoke detector, sprinkler head, water flow device or manual fire alarm. The message must provide applicable information and directions to occupants. [IBC 907.2.12.2]
 7. The fire department two-way communication system must operate between the central control station and every elevator, elevator lobby, exit stairway, and exit access corridor. In buildings equipped with fire pumps, a telephone station or jack shall be provided in each fire pump room. [IBC 403.7 and 907.2.12.3]

CHAPTER - 7

7. CONTROL SYSTEM

7.1. Stairwell smoke control detection and activation

Stairwell smoke control activation occurs on an alarm signal from any device, including sprinkler water flow switches, heat detectors, smoke detectors, and manual pull stations (pull boxes). Most stairwell smoke control systems operate in the same manner regardless of the source of the alarm signal.

Section 903.3.1.1, IBC requires complete automatic control to enable fast and accurate response for a smoke control system. Typical sequence of operation for a stairwell pressurization system is depicted below:

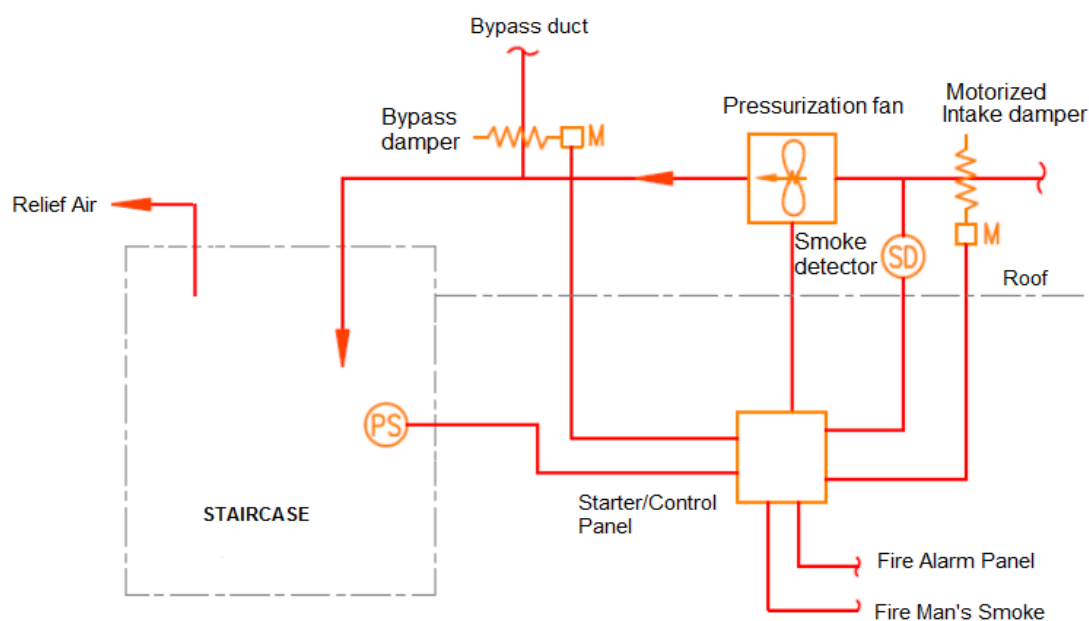

1. Any fire alarm in any zone of the building initiates smoke control mode.
2. System turns on the motorized damper on the air intake and the damper actuator signals pressurization fans to run.
3. A pressure sensor installed in the stairwell shall control the bypass damper to maintain a constant pressure of 50Pa within the stairwell.
4. A smoke detector (SD) is installed on the supply air intake. If it senses smoke, it must shut down the stairwell pressurization fan.

5. The fan should be wired for manual stopping.
6. It should be possible to override all controls and run the system through the fireman's smoke control panel (FSCP).

7.2. Operational schedules for pressurization systems

The three basic modes of operating pressurization systems are:

1. Pressurization plant normally off. In the event of a fire, the plant is switched on to its full duty.
2. Pressurization plant runs continuously at full duty during all hours of occupancy.
3. Pressurization plant runs continuously at reduced capacity during all hours of occupancy with a boost to full duty in the event of a fire.

The advantages and disadvantages of these three modes are discussed in detail in the following notes.

7.2.1. Plant off except in an emergency

This is an energy efficient method and meets the code requirements. The basic weakness is that there can be a delay between the start of a fire, its discovery and notification, and the starting of the pressurization plant.

7.2.2. Plant running continuously

This meets the objective of the availability of pressurization during the early stages of a fire, but this mode has the disadvantages of relatively high running costs and of difficulty in providing adequate environmental conditions on the escape routes during normal occupancy.

A particular reason for advocating running the pressurization systems continuously at reduced capacity is that they would serve the dual purpose of providing some smoke control at all times and providing the normal fresh air ventilation requirements for internal spaces.

7.2.3. Plant running continuously at reduced capacity except in an emergency

This mode seeks to overcome the objection of possible smoke infiltration on to escape routes before the fire alarm is raised by supplying sufficient air to limit the

smoke movement towards the escape routes and to dilute any smoke that does actually enter them. The cost saving of operating pressurization schemes at reduced capacity is quite substantial.

7.3. Smoke Control System Equipment

The smoke control system receives alarm signals from the Fire alarm control panel (FACP) and manual command signals from the Firefighter's smoke control station (FSCS). On receiving alarm signals and/or manual commands, the smoke control system controls the mechanical smoke control equipment. Manual command signals from the FSCS take priority over alarm signals.

The building fire alarm system is responsible for detecting an alarm condition, alerting occupants by audible and visual means, and signaling the smoke control system. Fire alarm system equipment includes: area, beam, and duct smoke detectors; manual pull stations; and sprinkler flow devices.

7.3.1. Fire alarm control panel (FACP)

The FACP receives alarm signals. If the FACP receives an alarm, it notifies the smoke control system of the alarm and the alarm location. The zone layout of the FACP must match the zone layout of the building to ensure that the FACP is capable of sending accurate signals to the smoke control system. The mechanical and electrical consulting engineers coordinate the building zone layout to the FACP layout to ensure a proper interface.

7.3.2. Firefighter's smoke control station (FSCS)

The firefighter's smoke control station (FSCS) enables firefighters to take manual control of the smoke control system. The fire-fighter's smoke control panel shall be installed in an approved location adjacent to the fire alarm control panel. The fire-fighter's smoke control panel shall comply with Sections 909.16.1 through 909.16.3 IBC.

The fire-fighter's control panel shall provide control capability over the complete smoke-control system equipment within the building as follows:

- ON-AUTO-OFF control over each individual piece of operating smoke control equipment that can also be controlled from other sources within the building. This includes stairway pressurization fans; smoke exhaust fans; supply, return

and exhaust fans; elevator shaft fans; and other operating equipment used or intended for smoke control purposes.

- OPEN-AUTO-CLOSE control over individual dampers relating to smoke control and that are also controlled from other sources within the building.
- ON-OFF or OPEN-CLOSE control over smoke control and other critical equipment associated with a fire or smoke emergency and that can only be controlled from the fire-fighter's control panel.
- The normal location is near the FACP or at a location acceptable to the Authority having Jurisdiction.
- The FSCS must be listed by Underwriters Laboratories (UL) as suitable for enabling firefighters to take manual control of the smoke control system.
- Commands from the FSCS control panel are the highest priority commands in the system. They override automatic control of smoke control system components.
- The FSCS provides a graphic representation of the building. It shows smoke control zones and associated smoke control mechanical equipment.
- The panel includes: lights, an audible trouble LED, and manual switches.
- Fans within the building shall be shown on the fire-fighter's control panel. A clear indication of the direction of airflow and the relationship of components shall be displayed.

IMPORTANT

The FSCS must be listed by Underwriters Laboratories (UL) as suitable for enabling firefighters to take manual control of the smoke control system.

Commands from the FSCS control panel are the highest priority commands in the system. They override automatic control of smoke control system components.

The FSCS provides a graphic representation of the building. It shows smoke control zones and associated smoke control mechanical equipment.

The panel includes: lights, an audible trouble LED, and manual switches.

7.3.3. Response Time

Smoke-control system activation shall be initiated immediately after receipt of an appropriate automatic or manual activation command. Smoke control systems shall activate individual components (such as dampers and fans) in the sequence necessary to prevent physical damage to the fans, dampers, ducts and other equipment. For the purposes of smoke control, the fire-fighter's control panel response time shall be the same for automatic or manual smoke control action initiated from any other building control point. The total response time, including that necessary for detection, shutdown of operating equipment and smoke control system startup shall allow for full operational mode to be achieved before the conditions in the space exceed the design smoke condition. The system response time for each component and their sequential relationships shall be detailed in the required rational analysis and verification of their installed condition reported in the required final report.

- Fan operation: 60 seconds
- Completion of damper travel: 75 seconds
- Smoke Management Systems: Full operational mode shall be achieved before conditions exceed design smoke conditions

7.3.4. Power systems

The smoke control system shall be supplied with two sources of power. Primary power shall be from the normal building power systems. Secondary power shall be from an approved standby source. The standby power source and its transfer switches shall be in a room separate from the normal power transformers and switch gears and ventilated directly to and from the exterior. The room shall be enclosed with not less than 1-hour fire barriers. The transfer to full standby power shall be automatic and within 60 seconds of failure of the primary power system.

7.3.5. Power sources and power surges

Elements of the smoke management system shall be supplied with uninterruptable power sources of sufficient duration to span a 15-minute primary power interruption. Elements of the smoke management system susceptible to power surges shall be suitably protected by conditioners, suppressors or other approved means.

7.3.6. Detection and control systems

Fire detection systems providing control input or output signals to mechanical smoke control systems or elements thereof shall comply with UL 864 and listed as smoke control equipment.

Control systems for mechanical smoke control systems shall include provisions for verification. Verification shall include positive confirmation of actuation, testing, manual override, the presence of power downstream of all disconnects and, through a preprogrammed weekly test sequence, report abnormal conditions audibly, visually and in a printed report format.

7.3.7. Verification of operation equipment

Codes require that the smoke control system provide verification of operation status indications at the FSCS. To accomplish this, the smoke control system shall provide devices that monitor the actual operation of fans and dampers. Such devices may include status switches, differential pressure switches, airflow paddle switches, current-sensing relays, limit switches and end switches. Status switches at fans and dampers monitor the operation of the devices.

Important

A current-sensing relay is the preferred way to confirm the operating status of a fan.

7.3.8. Wiring

In addition to meeting requirements of NFPA 70, all wiring, regardless of voltage, shall be fully enclosed within continuous raceways.

7.3.9. Emergency lighting

In buildings where artificial lighting is provided for normal use and occupancy, exit lighting and the illumination of the means of egress are required to assure occupants can quickly evacuate the building. All emergency lighting must be installed and tested in accordance with NFPA 111 (full 1½ hour test annually and 30-second test every 30 days).

CHAPTER - 8

8. STAIRWELL PRESSURIZATION ACCEPTANCE TESTING

Testing of stairwell pressurization systems should be conducted with established conditions including:

- Number and location of doors held open
- Outside pressure conditions known
- Maximum door pull force allowed

8.1. General conditions of testing

Tests should be carried out to check the performance of pressurization systems after completion and before occupation of the building. It is particularly important that the proper doors and windows are fitted and are in the closed position before air flow and pressure difference measurements are made. Vents to vertical shafts and on the leeward sides of the building that are required for pressurization relief should be open. Tests should not be carried out in winds stronger than 11 mph (5 m/s), since it would be difficult to allow for the adverse effects of wind on pressurization. An allowance may be made for stack effect per specific codes.

8.1.1. Pre-functional checklist

Pre-functional checklist items include, but not limited to, the following:

1. Fan systems and dampers (if applicable) are installed per contract documents and manufacturer's installation instructions.
2. Control system point-to-point checkout is complete to ensure all fan and damper input/output points are wired correctly.
3. Normal power, and emergency if applicable, is provided to each fan and damper assembly at proper voltage.
4. All fan systems have been balanced per the contract documents.
5. All safeties and interlocks, especially fan status and high pressure cut-outs, are installed and functioning per contract documents.

8.2. Sequence of operation

The sequence of operations for individual stairwell pressurization systems will vary depending on the application and design (non-compensated or compensated). In virtually all systems, isolation dampers will open (if applicable) and the supply fan will be commanded ON automatically upon an event signal.

In order to test the proper operation of the stairwell pressurization system (both non-compensated and compensated), initiate an event signal and perform the following:

1. Ensure all isolation dampers are open (if applicable) and supply fans turn ON.
2. Measure and record the pressure differential across each stairwell door with all doors closed. Measured pressure differential should exceed the value required by code. Note that the stack effect; wind speed and direction; and outdoor temperature may all influence measured pressures and system balance.
3. Measure and record the force needed to open one door using a spring scale. Hold door open and measure the pressure differential across each stairwell door again. Measured door opening force should not exceed code, while pressure differential across remaining doors should meet or exceed code.
4. Continuing from above, open the required number of doors one at a time, measuring and recording the force needed to open each door respectively, and the pressure differential across the remaining stairwell doors. Measured door opening force should not exceed code, while pressure differential across remaining doors should meet or exceed code requirements.
5. With all required doors open, determine the direction of air flow across each door opening. Verify that air flows from the stairwell to the occupied space.
6. For compensated systems, follow the same procedures as described above but with slightly different acceptance criteria. That is, the design stairwell pressure setpoint should be maintained throughout the test, and the response time of the control algorithm must be checked. The response time of the pressurization control loop should not allow short-term pressure values to fall below the value required by code.

8.3. Activation of the system

This test shall operate the automatic fire detection system (smoke detector) by injecting smoke into the detector head. This shall in turn operate the central fire alarm panel, thus activating the pressure differential system.

During this test all key components of the pressure differential system shall be inspected.

8.4. Pressure differential

This test shall measure pressure differential across each door separating a pressurized and unpressurized space to the relevant accommodation on the floor levels with the pressure differential system running. The tests shall be carried out as follows:

- a. Initiate the pressure differential system operation. Allow fans to operate for 10 min to establish steady air temperatures;
- b. Measure the pressure differential between the pressurized space and the relevant accommodation;
- c. Measure the pressure differential between the pressurized staircase and the relevant accommodation.

These readings shall be taken using a calibrated manometer, with appropriate tube connections.

8.5. Air velocity

This test shall be to measure the air velocity through an open door separating a pressurized and an unpressurized space, and shall comply with the requirements in Clause 5.4 for the appropriate design objective. The tests shall be carried out as follows:

- a. Actuate the pressure differential system.
- b. Measurement of flow velocity through the relevant doors shall be taken with all other doors open or closed in accordance with the appropriate design objective described in Table 4. The doorway shall be clear of obstructions.

- c. Take at least 8 measurements, uniformly distributed over the doorway, to establish an accurate air velocity.
- d. Calculate the mean of these measurements, or alternatively move an appropriate measuring device steadily over the cross section of the open door and record the average air velocity.
- e. The measurements shall be taken using a calibrated anemometer providing an accuracy of +/- 5%.

8.6. Door opening force

This test shall measure the opening door force on the doors between pressurized and unpressurized spaces.

The opening door force shall be measured as follows:

- a. Actuate the pressure differential system.
- b. Fasten the end of the force measuring device (e.g. spring balance) to the door handle, on the side of the door in the direction of opening.
- c. Release any latching mechanism, if necessary holding it open.
- d. Pull steadily on the free end of the force measuring device, noting the highest value of force measured as the door opens.
- e. Take at least 3 measurements and calculate their mean.

8.7. Alarm system test

Tests should be made to ensure that the pressurization system is brought into operation by manual and automatic alarm systems, i.e. the pressurization fan(s) are started, or are boosted to full capacity when reduced level pressurization is provided. In addition cancellation of the alarm should not shut down pressurization fans.

8.8. Qualifications

Special inspection agencies for smoke control shall have expertise in fire protection engineering, mechanical engineering and certification as air balancers.

8.9. Reports

A complete report of testing shall be prepared by the special inspector or special inspection agency. The report shall include identification of all devices by

manufacturer, nameplate data, design values, measured values and identification tag or mark. The report shall be reviewed by the responsible registered design professional and, when satisfied that the design intent has been achieved, the responsible registered design professional shall seal, sign and date the report.

8.10. Documentation

The following documents shall be generated by the designer during the design process:

1. Detailed design report
2. Operations and maintenance manual [NFPA 92-12: 7.1]

8.10.1. Detailed Design Report

The detailed design report shall provide documentation of the smoke control system as it is designed and intended to be installed. [NFPA 92-12: 7.2.1]

The design report shall include the following elements, if applicable:

1. System purpose
2. System design objectives
3. Design approach
4. Design assumptions (building height, ambient conditions, reliance on other fire protection systems, leakage, etc.)
5. Location of smoke zone(s)
6. Design pressure differences
7. Building use limitations that arise out of the system design
8. Design calculations
9. Fan and duct specifications
10. Damper specifications
11. Detailed inlet or exhaust inlets site information
12. Detailed method of activation
13. Smoke control system operation logic

14. System commissioning procedures [NFPA 92-12: 7.2.2]

All documents identifying and locating each component of the smoke control system, and describing its proper function and maintenance requirements, shall be filed with the fire code official, and an identical copy shall be maintained in an approved location in the building (required by IBC Section 909.18.8.3). Devices shall have an approved identifying tag or mark on them consistent with the other required documentation and shall be dated indicating the last time they were successfully tested and by whom.

8.10.2. Operations and Maintenance Manual

The operations and maintenance manual shall provide the requirements to ensure the proper operation of the system over the life of the building. [NFPA 92-12: 7.3]

The operations and maintenance manual shall include the following:

1. The procedures used in the initial commissioning of the system as well as the measured performance of the system at the time of commissioning.
2. The testing and inspection requirements for the system and system components and the required frequency of testing (see NFPA 92, Chapter 8).
3. The critical design assumptions used in the design and limitations on the building and its use that arise out of the design assumptions and limitations.
4. The purpose of the smoke control system [NFPA 92-12: 7.3.1].
5. Copies of the operations and maintenance manual shall be provided to the owner and the authorities having jurisdiction. [NFPA 92-12:7.3.2].
6. The building owner shall be responsible for all system testing and shall maintain records of all periodic testing and maintenance in accordance with the operations and maintenance manual. [NFPA 92-12: 7.3.3].
7. The building owner shall be responsible for limiting the use of the space in a manner consistent with the limitations provided in the operations and maintenance manual. [NFPA 92-12: 7.3.4].

The testing documentation and owner's manuals and instructions should be kept on file for the intended service life of the system.

Summary

The predominant means for improving the environment in high-rise stair enclosures is to protect the stairs using stair pressurization systems. Stair pressurization systems must be properly designed to avoid creating adverse conditions to exiting, such as unacceptably high door opening forces due to stack effect.

The reliability of electrical power source to drive the fan during emergency should be carefully studied. Whatever may be the arrangement, the electrical supply to the pressurization fans should not be interrupted. Even if an emergency generator is provided, the route by which the power is brought to the fans should be such that it is not likely to be affected by the potential fire.

Designing stair pressurization systems shall be best left to an experienced fire protection engineer who could have access to all construction details. Remember that over pressurizing the stair may possibly cost more harm than good.

References

- a. Design of Smoke Management Systems – Klote and Milke
- b. IBC 909.6 – “Pressurization Method” and NFPA 92A – Enclosed spaces, pressure differential developed for containment.
- c. IBC 909.8 “Exhaust Method” and NFPA 92B – Open spaces, smoke exhaust to maintain smoke layer above people on highest occupied level.