

---

# Principles of Water Treatment

Course No: H03-002

Credit: 3 PDH

---

Gilbert Gedeon, P.E.

---

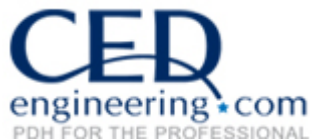

Continuing Education and Development, Inc.  
22 Stonewall Court  
Woodcliff Lake, NJ 07677

P: (877) 322-5800  
[info@cedengineering.com](mailto:info@cedengineering.com)

---

**Department of Energy  
Fundamentals Handbook**

**CHEMISTRY  
Module 4  
Principles of Water Treatment**

## **TABLE OF CONTENTS**

---

LIST OF FIGURES .....	ii
LIST OF TABLES .....	iii
REFERENCES .....	iv
OBJECTIVES .....	v
PURPOSE OF WATER TREATMENT .....	1
Water Treatment .....	1
Summary .....	2
WATER TREATMENT PROCESSES .....	3
Principles of Ion Exchange .....	3
Specific Ion Exchanger Reactions .....	11
Summary .....	13
DISSOLVED GASES, SUSPENDED SOLIDS, AND pH CONTROL .....	15
Removal of Dissolved Gases .....	15
Removal of Suspended Solids .....	20
pH Control .....	21
Resin Bed Malfunctions .....	22
Summary .....	26
WATER PURITY .....	28
Water Purity .....	28
Summary .....	30

## LIST OF FIGURES

---

Figure 1	Polymerization of Cross-Linked Polystyrene Resins .....	5
Figure 2	Production of Anion and Cation Forms of Cross-Linked Polystyrene Ion Exchange Resins .....	6
Figure 3	Schematic Diagram of a Typical Ion Exchanger .....	8
Figure 4	Typical History Curve .....	11
Figure 5	A Typical Pretreatment System .....	16
Figure 6	Behavior of Hydrogen Form Cation Exchange Bed as it Removes Ammonium Ions From Solution .....	23

---

## **LIST OF TABLES**

---

Table 1 Typical Ionized Impurities in Water .....	2
Table 2 Properties of Ion Exchange Resins .....	9
Table 3 Water Purity .....	28

---

## REFERENCES

---

- Donald H. Andrews and Richard J. Kokes, Fundamental Chemistry, John Wiley & Sons, Inc., 1963
- Compressed Gas Association, Inc., Handbook of Compressed Gases, 2nd Edition, Reinhold Publishing Corporation, 1981.
- R. A. Day, Jr. and R. C. Johnson, General Chemistry, Prentice Hall, Inc., 1974.
- Dickerson, Gray, Darensbourg and Darensbourg, Chemical Principles, 4th Edition, The Benjamin Cummings Publishing Company, 1984.
- Academic Program for Nuclear Plant Personnel, Volume II, Chemistry, Columbia, MD, General Physics Corporation, Library of Congress Card #A 326517, 1972.
- General Physics Corporation, Fundamentals of Chemistry, General Physics Corporation, 1982.
- Glasstone and Sesonske, Nuclear Reactor Engineering, 3rd Edition, Van Nostrand Reinhold Company, 1981.
- McElroy, Accident Prevention Manual for Industrial Operations Engineering and Technology, Volume 2, 8th Edition, National Safety Council, 1980.
- Sienko and Plane, Chemical Principles and Properties, 2nd Edition, McGraw and Hill, 1974.
- Underwood, Chemistry for Colleges and Schools, 2nd Edition, Edward Arnold, Ltd., 1967.
- Norman V. Steere and Associates, CRC Handbook of Laboratory Safety, 2nd Edition, CRC Press, Inc., 1971.

---

## **PURPOSE OF WATER TREATMENT**

---

*Water normally contains many impurities, among which are trace minerals and chemicals. The need for removing these impurities is discussed in this chapter.*

**EO 1.1 LIST the three reasons for removing impurities from water prior to use in reactor systems.**

---

### **Water Treatment**

Water treatment is necessary to remove the impurities that are contained in water as found in nature. Control or elimination of these impurities is necessary to combat corrosion, scale formation, and fouling of heat transfer surfaces throughout the reactor facility and support systems.

The following are three reasons for using very pure water in reactor facility systems.

1. To minimize corrosion, which is enhanced by impurities.
2. To minimize radiation levels in a reactor facility. Some of the natural impurities and most of the corrosion products become highly radioactive after exposure to the neutron flux in the core region. If not removed, these soluble and insoluble substances may be carried to all parts of the system.
3. To minimize fouling of heat transfer surfaces. Corrosion products and other impurities may deposit on core surfaces and other heat transfer regions, which result in decreased heat transfer capabilities by fouling surfaces or blockage of critical flow channels. Areas of high concentrations of these impurities and corrosion products may also lead to extreme conditions of the various corrosion processes with resultant failure of components or systems.

There are several processes used in reactor facilities to purify the water in the systems and water used as makeup. Deaeration is used to strip dissolved gases, filtration is effective in the removal of insoluble solid impurities, and ion exchange removes undesirable ions and replaces them with acceptable ions. Typical ionized impurities found in water are shown in Table 1.

<b>TABLE 1</b>	
<b>Typical Ionized Impurities in Water</b>	
Cations	Anions
$\text{Ca}^{++}$	$\text{NO}_3^-$
$\text{Mg}^{++}$	$\text{OH}^-$
$\text{Na}^+$	$\text{SO}_4^{--}$
$\text{K}^+$	$\text{Cl}^-$
$\text{Al}^{+++}$	$\text{HCO}_3^-$
$\text{Fe}^{++}$	$\text{HSiO}_3^-$
$\text{Cu}^{++}$	$\text{HCrO}_3^-$

## **Summary**

The important information in this chapter is summarized below.

### **Purpose of Water Treatment Summary**

- There are three general reasons to treat water for its impurities:
  1. To minimize corrosion, which is enhanced by impurities
  2. To minimize radiation levels in the reactor facility
  3. To minimize fouling of heat transfer surfaces



---

## WATER TREATMENT PROCESSES

---

One of the more common water treatment methods is the use of demineralizers and ion exchange. This method will be discussed in this chapter.

**EO 1.2      DEFINE the following terms:**

- |                             |  |
|-----------------------------|--|
| <b>a.      Ion exchange</b> | <b>e.      Polymer</b>                 |
| <b>b.      Demineralize</b> | <b>f.      Mixed-bed demineralizer</b> |
| <b>c.      Cation</b>       | <b>g.      Affinity</b>                |
| <b>d.      Anion</b>        | <b>h.      Decontamination factor</b>  |

**EO 1.3      DESCRIBE the following:**

- a.      Resin bead**
- b.      Cation resin**
- c.      Anion resin**

**EO 1.4      DISCUSS the following factors of ion exchange:**

- a.      Relative affinity**
- b.      Decontamination factor**

**EO 1.5      WRITE the reaction for removal of NaCl and CaSO<sub>4</sub> by a mixed-bed ion exchanger such as one containing HOH resin.**

---

### Principles of Ion Exchange

Ion exchange is a process used extensively in nuclear facilities to control the purity and pH of water by removing undesirable ions and replacing them with acceptable ones. Specifically, it is the exchange of ions between a solid substance (called a resin) and an aqueous solution (reactor coolant or makeup water). Depending on the identity of the ions that a resin releases to the water, the process may result in purification of water or in control of the concentration of a particular ion in a solution. An *ion exchange* is the reversible exchange of ions between a liquid and a solid. This process is generally used to remove undesirable ions from a liquid and substitute acceptable ions from the solid (resin).

The devices in which ion exchange occurs are commonly called demineralizers. This name is derived from the term *demineralize*, which means the process whereby impurities present in the incoming fluid (water) are removed by exchanging impure ions with H<sup>+</sup> and OH<sup>-</sup> ions, resulting in the formation of pure water. H<sup>+</sup> and OH<sup>-</sup> are present on the sites of resin beads contained in the demineralizer tank or column.

There are two general types of ion exchange resins: those that exchange positive ions, called cation resins, and those that exchange negative ions, called anion resins. A *cation* is an ion with a positive charge. Common cations include  $\text{Ca}^{++}$ ,  $\text{Mg}^{++}$ ,  $\text{Fe}^{++}$ , and  $\text{H}^+$ . A *cation resin* is one that exchanges positive ions. An *anion* is an ion with a negative charge. Common anions include  $\text{Cl}^-$ ,  $\text{SO}_4^-$ , and  $\text{OH}^-$ . An *anion resin* is one that exchanges negative ions. Chemically, both types are similar and belong to a group of compounds called *polymers*, which are extremely large molecules that are formed by the combination of many molecules of one or two compounds in a repeating structure that produces long chains.

A *mixed-bed demineralizer* is a vessel, usually with a volume of several cubic feet, that contains the resin. Physically, ion exchange resins are formed in the shape of very small beads, called *resin beads*, with an average diameter of about 0.5 millimeters. Wet resin has the appearance of damp, transparent, amber sand and is insoluble in water, acids, and bases. Retention elements or other suitable devices in the top and bottom have openings smaller than the diameter of the resin beads. The resin itself is a uniform mixture of cation and anion resins in a specific volume ratio depending on their specific gravities. The ratio is normally 2 parts cation resin to 3 parts anion resin.

In some cases, there may be chemical bonds formed between individual chain molecules at various points along the chain. Such polymers are said to be cross-linked. This type of polymer constitutes the basic structure of ion exchange resins. In particular, cross-linked polystyrene is the polymer commonly used in ion exchange resins. However, chemical treatment of polystyrene is required to give it ion exchange capability, and this treatment varies depending on whether the final product is to be an anion resin or a cation resin.

The chemical processes involved in producing anion and cation resins are outlined in Figure 1 and Figure 2, beginning with the formation of cross-linked polystyrene. The polymer itself is a covalent compound. By the chemical reactions indicated in Figure 2, hydrogen atoms covalently bonded to the original polymer at certain sites are replaced by functional groups (called radicals) such as  $\text{SO}_3\text{H}$  (sulfonic acid) and  $\text{CH}_2\text{N}(\text{CH}_3)_3\text{Cl}$  (quaternary ammonium). Each such group is covalently bonded to the polymer, but each also contains an atom that is bonded to the radical group by a predominantly ionic bond. In the two examples above, H in  $\text{SO}_3\text{H}$  and Cl in  $\text{CH}_2\text{N}(\text{CH}_3)_3\text{Cl}$  are the ionically-bonded atoms. Sometimes these are written as  $\text{SO}_3^- \text{H}^+$  and  $\text{CH}_2\text{N}(\text{CH}_3)_3^+ \text{Cl}^-$  to emphasize their ionic characters. These ions ( $\text{H}^+$  and  $\text{Cl}^-$ ) are replaceable by other ions. That is,  $\text{H}^+$  will exchange with other cations in a solution, and  $\text{Cl}^-$  will exchange with other anions.

In its final form, an ion exchange resin contains a huge, but finite, number of sites occupied by an exchangeable ion. All of the resin, except the exchangeable ion, is inert in the exchange process. Thus, it is customary to use a notation such as R-Cl or H-R for ion exchange resins. R indicates the inert polymeric base structure and the part of the substituted radical that does not participate in exchange reactions. The term R is inexact because it is used to represent the inert portion of both cation and anion resins, which are slightly different. Also, the structure represented by R contains many sites of exchange, although only one is shown by the notation, such as R-Cl. Despite these drawbacks, the term R is used for simplicity.

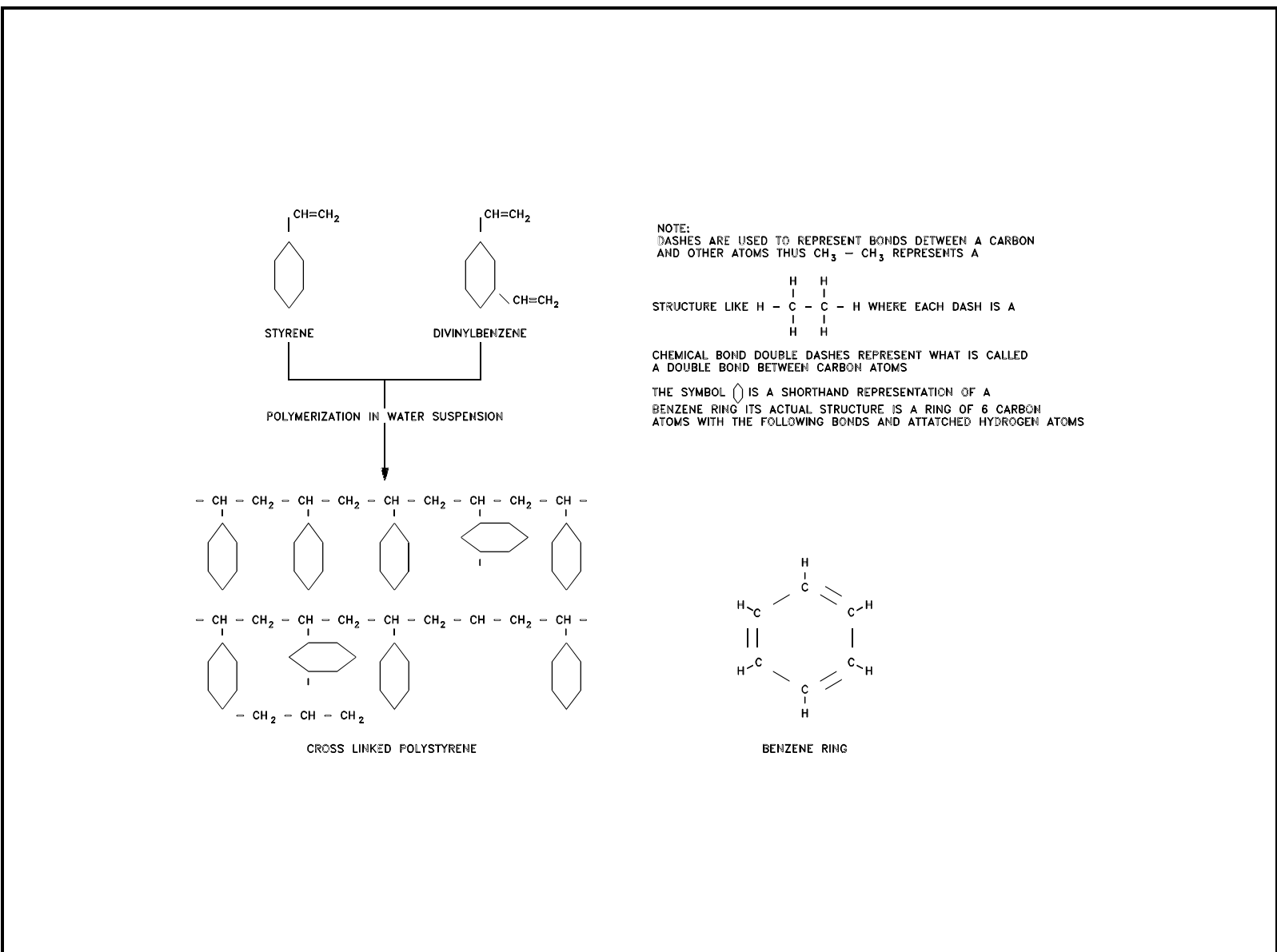

Figure 1 Polymerization of Cross-Linked Polystyrene Resins



A particular resin may be prepared in different forms according to the identity of the exchangeable ion attached. It is usually named according to the ion present on the active sites. For example, the resin represented by R-Cl is said to be the chloride form of the anion resin, or simply the chloride form resin. Other common forms are the ammonium form (NH<sub>4</sub>-R), hydroxyl form (R-OH), lithium form (Li-R), and hydrogen form (H-R).

The mechanics of the ion exchange process are somewhat complicated, but the essential features can be understood on the basis of equilibrium concepts discussed in Module 1 and recognition that the strength of the ionic bond between the resin and an ion varies with the particular ion. That is, for a particular resin, different ions experience different attractions to the resin. The term *affinity* is often used to describe the attraction between a resin and a given ion. This affinity can be described quantitatively by experimental determination of a parameter called the relative affinity coefficient. For a qualitative discussion, it suffices to note the *relative affinities* between a resin and different ions.

In order of decreasing strength, the relative affinities between a cation resin and various cations are as follows.

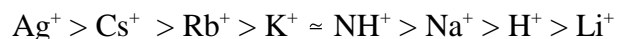
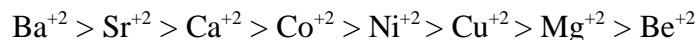

Similarly, the relative affinities between an anion resin and various anions are as follows.



The physical arrangement of one type of ion exchange vessel for purifying water is shown in Figure 3. The ion exchange resin is contained in a vessel with a volume of several cubic feet. Retention elements at the top and bottom consist of screens, slotted cylinders, or other suitable devices with openings smaller than the resin beads to prevent the resin from escaping from the vessel. The resin bed is a uniform mixture of cation and anion resins in a volume ratio of 2 parts cation resin to 3 parts anion resin. This arrangement is called a mixed-bed resin, as opposed to an arrangement of cation and anion resins in discrete layers or separate vessels. The use of different volumes of the two types of resins is due to the difference in exchange capacity between cation and anion resins. *Exchange capacity* is the amount of impurity that a given amount of resin is capable of removing, and it has units of moles/ml, equivalents/ml, or moles/gm. The anion resin is less dense than the cation resin; thus, it has a smaller exchange capacity, and a larger volume is needed for anion resins than for the cation resins to obtain equal total exchange capabilities.

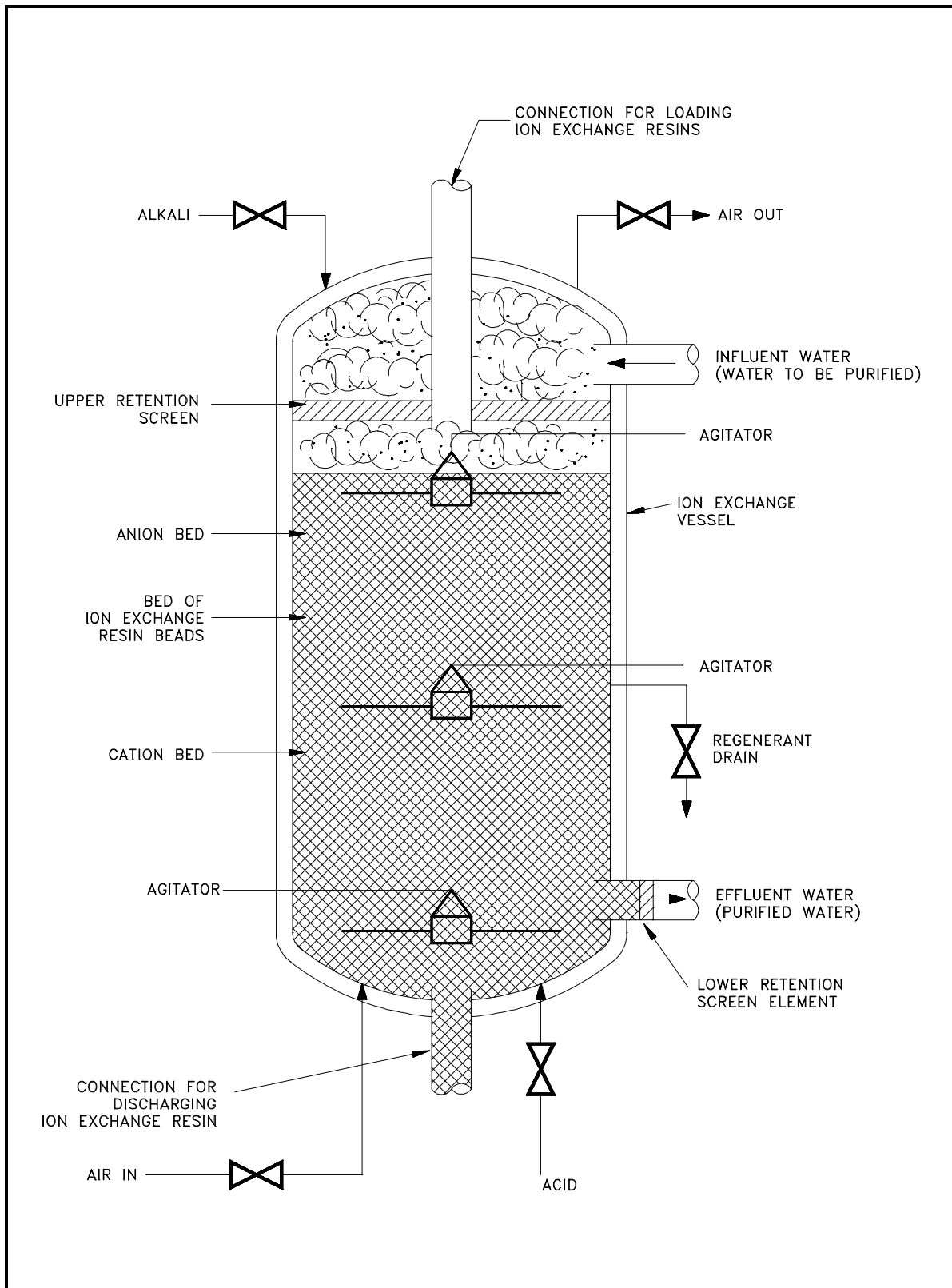

Figure 3 Schematic Diagram of a Typical Ion Exchanger

Because of the different densities of anion and cation resins, the flow of solution (impure water) is from top to bottom. If the flow were reversed, the lighter anion resin would gradually rise to the top by a process called classification, resulting in a layer of anion resin on top of the cation resin, as shown in Figure 3. In the example shown, the layering results from regeneration and/or backwash. In systems not using a backwash, the anion and cation resin beads are uniformly mixed. Many systems use a backwash procedure, if the resins are regenerated, to remove solids collected by filtration and to separate the resins for regeneration. They are remixed after regeneration.

For fixed amounts of anion and cation resins, the efficiency for removal of impurities is greater in a mixed-bed resin than a layered arrangement. The main reason is that for layered resins there may be large pH gradients within the column of resin. If, for example, the hydroxyl form resin is on top, as solution passes through it anionic impurities are removed and replaced by  $\text{OH}^-$  ions; thus, the pH increases. This increase in pH may decrease the efficiency in lower portions of the resin bed for removing impurities. It may also cause some impurities to precipitate because solubility changes with pH. The resin column will filter some undissolved material, but the efficiency for filtration is usually significantly less than that for removal by ion exchange. Thus, the overall efficiency is less than in a mixed-bed resin.

The capacity of ion exchange resins to remove impurity ions is given in Table 2 along with other information on resins. For instance, each cubic foot of a mixed-bed resin is capable of exchanging with 19.8 moles each of monovalent cations and anions. Mixed-bed resins are available commercially and in practical applications several cubic feet are used in a purification system.

Properties	Cation Resin	Anion Resin	Mixed-Bed Resin
Ion exchange capacity, moles of single ion/ml	$1.75 \times 10^{-3}$	$1.20 \times 10^{-3}$	$0.7 \times 10^{-3}$ anion & cation
Ion exchange capacity, moles of single ion/ft <sup>3</sup>	49.5	34.0	19.8 anion & cation
Density of wet resin particles, grams/ml	1.27	1.10	--
Bulk density of loaded bed (including voids), grams/ml	0.80	0.62	0.70
Volume fraction	--	--	60% anion & 40% cation

The ion exchange process is reversible. If too much solution is passed through the ion exchanger (that is, the capacity of the resin has been exceeded) the exchange may reverse, and undesirable ions or other substances that were previously removed, will be returned to the solution at the effluent. Therefore, it is necessary to periodically monitor the performance of the ion exchanger and either replace or regenerate the resin when indicated. Ion exchanger performance is measured by comparing the solution concentration, conductivity, or radioactivity at the influent and effluent. The parameter measured depends upon the purpose of the ion exchanger. The term normally applied to ion exchanger effectiveness is *decontamination factor* (DF), which is defined as a ratio of the concentration (or activity) of the fluid at the inlet compared to the concentration (or activity) at the effluent, which expresses the effectiveness of an ion exchange process.

$$DF = \frac{\text{Influent concentration, conductivity, or radioactivity}}{\text{Effluent concentration, conductivity, or radioactivity}}$$

Example 1:

An ion exchanger influent contains 15 ppm chloride (Cl). Effluent chloride is measured at 0.1 ppm. What is the DF of this ion exchanger?

Solution:

$$DF = \frac{\text{Influent concentration}}{\text{Effluent concentration}}$$

$$DF = \frac{15 \text{ ppm Cl}}{0.1 \text{ ppm Cl}}$$

$$DF = 150$$

Example 2:

Reactor coolant activity entering the purification ion exchanger equals  $2.8 \times 10^{-2}$   $\mu\text{Ci/ml}$  gross activity. Ion exchanger effluent activity taken at the same time and conditions is measured at  $1.0 \times 10^{-4}$   $\mu\text{Ci/ml}$ . What is the DF?

Solution:

$$DF = \frac{\text{Influent radioactivity}}{\text{Effluent radioactivity}}$$

$$DF = \frac{2.8 \times 10^{-2} \mu\text{Ci/ml}}{1.0 \times 10^{-4} \mu\text{Ci/ml}}$$

$$DF = 280$$



Resin performance may be monitored using a history curve that plots DF with respect to time. A typical history curve is shown in Figure 4, with the resin considered "exhausted" at point X.

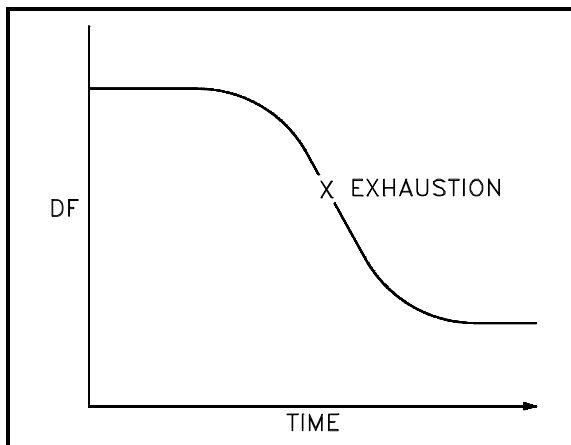
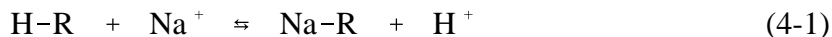

Figure 4 Typical History Curve

### **Specific Ion Exchanger Reactions**

Suppose a solution containing  $\text{Na}^+$  ions is passed through hydrogen resin. From the relative affinities given earlier,  $\text{Na}^+$  ions are attracted to the resin more strongly than  $\text{H}^+$  ions. Thus,  $\text{Na}^+$  ions will displace  $\text{H}^+$  ions from the resin or, in other words,  $\text{Na}^+$  ions and  $\text{H}^+$  ions exchange place between resin and solution. The process can be described by the following equilibrium reaction.



In most practical situations, a solution containing impurities at low concentrations is passed through a large amount of resin. By LeChatelier's Principle, the equilibrium of Reaction (4-1) is forced far to the right. The equilibrium is displaced so far that, for practical purposes, all  $\text{Na}^+$  ions are removed from solution and replaced by  $\text{H}^+$  ions. As a result, the solution will be acidic because of the excess of  $\text{H}^+$  ions.

If a solution containing  $\text{Cl}^-$  ions is passed through hydroxyl resin, the  $\text{Cl}^-$  ions will be removed according to the following reaction.

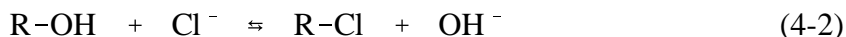

Again, for a dilute solution and a large amount of resin, the removal of  $\text{Cl}^-$  ions is essentially 100 percent complete. In this case, the final solution will be basic because of the excess of  $\text{OH}^-$  ions.

Consider a situation in which the entering impurities are calcium sulfate ( $\text{CaSO}_4$ ) and sodium chloride ( $\text{NaCl}$ ), and the ion exchanger is a mixture of both hydrogen and hydroxyl resins (mixed-bed).

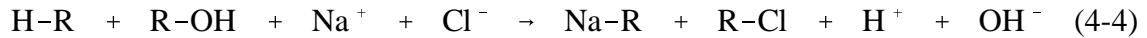

In the reaction with  $\text{NaCl}$ , both  $\text{Na}^+$  and  $\text{Cl}^-$  ions are removed from solution and replaced by  $\text{H}^+$  and  $\text{OH}^-$  ions, respectively (the  $\text{CaSO}_4$  reaction has the same result). If the initial solution contained only  $\text{NaCl}$ , then the concentrations of  $\text{Na}^+$  and  $\text{Cl}^-$  ions were equal. Because both are removed with 100 percent efficiency, the concentrations of  $\text{H}^+$  and  $\text{OH}^-$  ions added to the solution are equal; thus, the solution is neutral. In solution,  $\text{H}^+$  and  $\text{OH}^-$  ions must obey the relationship for the ionization of water (refer to Module 1).

$$K_w = 10^{-14} = [\text{H}^+] [\text{OH}^-]$$

Because of the very small value of the dissociation constant  $K_w$ , the great majority of  $\text{H}^+$  and  $\text{OH}^-$  ions supplied by the resin must combine to form water by the following reaction.



By this process, the original  $\text{NaCl}$  solution becomes pure water.

The preceding examples involve hydrogen and hydroxyl resins. The use of other resins, especially cation resins, is very common. For instance, suppose a solution containing  $\text{Na}^+$  ions is passed through a lithium resin. Again referring to the relative affinities,  $\text{Na}^+$  is attracted to the resin more strongly than is  $\text{Li}^+$ ; thus,  $\text{Na}^+$  ions will displace  $\text{Li}^+$  from the resin.

## Summary

The important information in this chapter is summarized below.

### **Ion Exchange Summary**

- Demineralize is defined as the process whereby impurities present in the incoming fluid (water) are removed by exchanging impure ions with  $H^+$  and  $OH^-$  ions resulting in the formation of pure water.
- Ion exchange is a process used extensively in nuclear facilities to control the purity and pH of water by removing undesirable ions and replacing them with acceptable ones.
- Mixed-bed demineralizer is a vessel containing resin that is a uniform mixture of cation and anion resins in a specific volume ratio depending on their specific gravities. Normally the ratio is 2 parts cation resin to 3 parts anion resin.
- Cation is an ion with a positive charge. Common cations include  $Ca^{++}$ ,  $Mg^{++}$ ,  $Fe^{++}$ , and  $H^+$ . A cation resin is one that exchanges positive ions.
- Anion is an ion with a negative charge. Common anions include  $Cl^-$ ,  $SO_4^{-2}$ , and  $OH^-$ . An anion resin is one that exchanges negative ions.
- Decontamination factor (DF) is a ratio of the concentration (or activity) of the fluid at the inlet compared to the concentration (or activity) at the effluent, which defines the effectiveness of the ion exchange process. Mathematically it is:

$$DF = \frac{\text{Influent concentration, conductivity, or radioactivity}}{\text{Effluent concentration, conductivity, or radioactivity}}$$

- Polymers are extremely large molecules that are formed by the combination of many molecules of one or two compounds in a repeating structure that produces long chains.
- Affinity is often used to describe the attraction between a resin and a given ion. This affinity can be described quantitatively by experimental determination of a parameter called the relative affinity coefficient.

### Ion Exchange Summary (Cont.)

- Resin beads are long-chain cross-linked polymers that contain sites occupied by exchangeable ions. The general order of affinity serves as a useful guide in understanding many ion exchange processes. Cation and anion resins are named according to the identity of the ion occupying the exchange sites, such as hydrogen, hydroxyl, and chloride. Mixed-bed resins are used to remove both cations and anions.
- The effectiveness of any ion exchanger is directly related to the relative affinities between a resin and different ions. In order of decreasing strength, the relative affinities between a cation resin and various cations are:

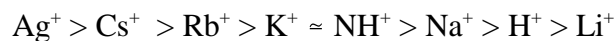
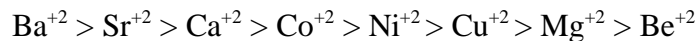

Similarly, the relative affinities of the anion resin for various anions are:



The higher the relative affinity the more effective the ion exchanger. This effectiveness is expressed by the Decontamination Factor.

- The reaction for removal of NaCl and CaSO<sub>4</sub> by a mixed-bed ion exchanger such as one containing HOH resin is as follows:

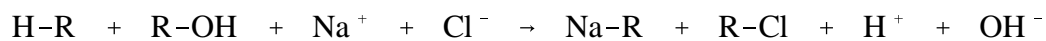
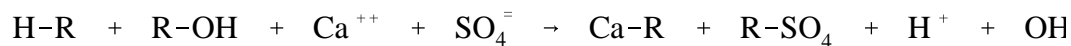

---

## **DISSOLVED GASES, SUSPENDED SOLIDS, AND pH CONTROL**

---

*The presence of dissolved gases, suspended solids, and incorrect pH can be detrimental to the water systems associated with a reactor facility. Therefore, these conditions must be minimized or eliminated to reduce corrosion in the systems of the facility. The way these conditions are controlled and the difficulties in controlling them are discussed in this chapter.*

- EO 1.6**      **EXPLAIN the three basic methods used to remove dissolved gases from water.**
- EO 1.7**      **LIST five filtration mediums used to remove suspended solids from water.**
- EO 1.8**      **EXPLAIN how mixed-bed ion exchangers may be used to control pH.**
- EO 1.9**      **DISCUSS resin malfunctions, including the following:**
- a.      Channeling**
  - b.      Breakthrough**
  - c.      Exhaustion**

---

### **Removal of Dissolved Gases**

Dissolved gases result from different sources depending upon which system we examine. In the following discussion, we will address makeup water, reactor coolant systems, secondary facility water systems, the sources of dissolved gases, and methods used to reduce their concentrations to acceptable levels.

Many facilities use raw water as a source for makeup water systems. Pretreatment of this water is accomplished in various ways from distillation to a series of distinct processes as shown in Figure 5. In a pretreatment system similar to that shown in Figure 5, a resin column containing a cation resin (hydrogen form) is used to remove cations. The water entering the cation exchanger contains numerous ions including sodium ( $\text{Na}^+$ ), bicarbonate ( $\text{HCO}_3^-$ ), and others ( $\text{HCO}_3^-$  is one of the major impurities in many raw water systems).  $\text{Na}^+$  ions result from the water softener located upstream in the pretreatment system. In addition to the  $\text{HCO}_3^-$  ions, raw water contains large amounts of magnesium ( $\text{Mg}^{++}$ ) and calcium ( $\text{Ca}^{++}$ ), as well as small amounts of other ionic impurities.

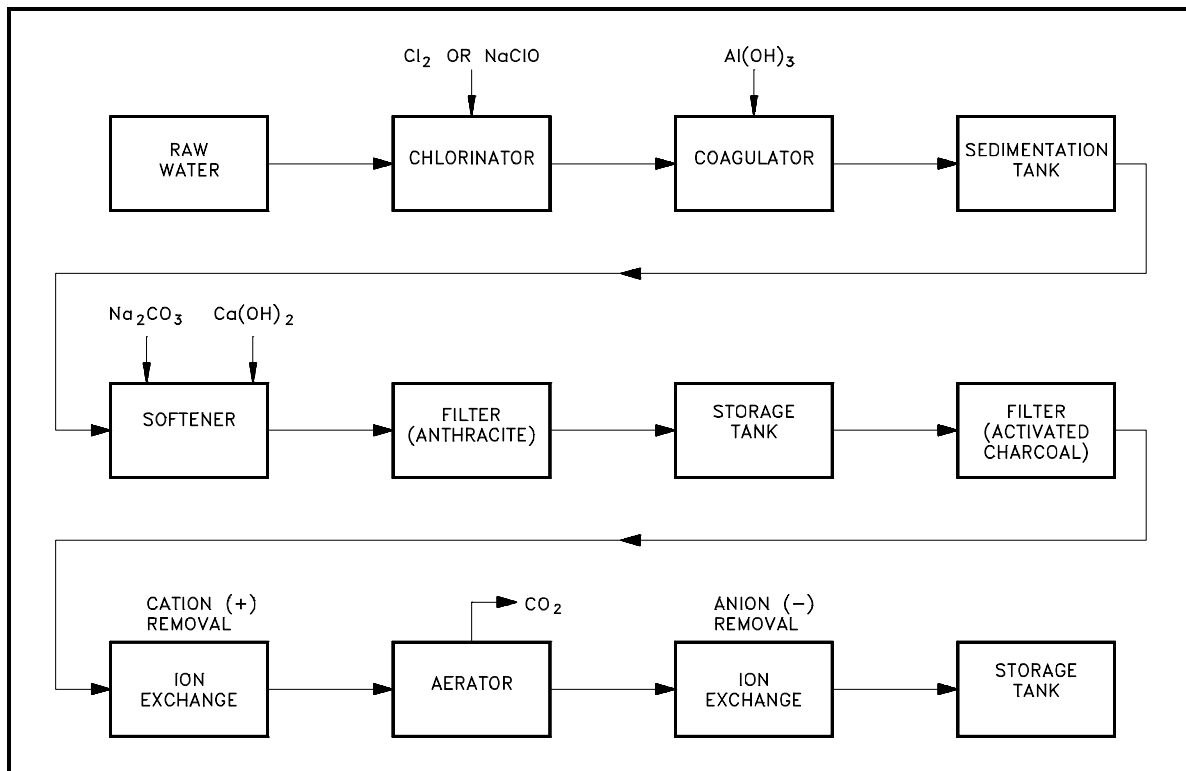
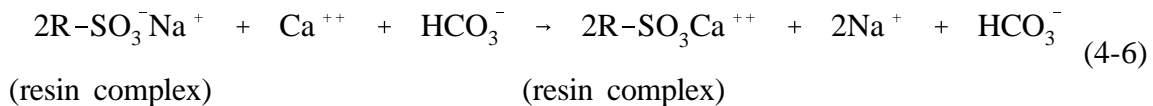

Figure 6 A Typical Pretreatment System

The reactions that occur in the water softener include the removal of both  $Mg^{++}$  and  $Ca^{++}$  ions. The water softener contains resin in which the insoluble exchange site is the  $SO_3^-$  molecule, and the soluble ions attached to the exchange site are  $Na^+$  ions. When water containing  $Mg^{++}$ ,  $Ca^{++}$ , and  $HCO_3^-$  ions is passed over the resin in the softener, the ions are exchanged by the following reaction ( $Mg^{++}$  removal is similar).



Note that electrical neutrality is maintained before and after the exchange reaction. One calcium ion with two positive charges is attached to two exchange sites that release two sodium ions with one positive charge each. The  $HCO_3^-$  ion is not affected by the reaction and passes through the resin of the softener.

To obtain pure water, it is necessary to demineralize the water completely, which is accomplished using a cation exchanger, an aerator, and an anion exchanger.

The cation exchanger contains resin in the hydrogen form. In this treatment step, essentially all cations entering the ion exchanger will be held at the exchange site, and  $H^+$  will be released as shown in the following typical reaction (the anions, specifically the  $HCO_3^-$  ions, are unaffected by the cation exchanger).



The water leaving the resin is somewhat acidic (depending on the incoming ion concentration) because it contains  $H^+$  ions and whatever anion was associated with the incoming cation. After passing through the cation resin, the  $HCO_3^-$  ions combine with the  $H^+$  ions to form carbonic acid ( $H_2CO_3$ ). Carbonic acid is a weak acid that will decompose to water and  $CO_2$  by the following reaction.

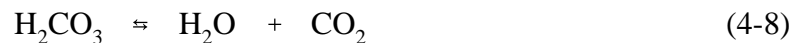

Because the carbonic acid readily dissociates, the aerator is used to remove the  $CO_2$  from the makeup water at this point in the system. If we aerate the water by some means, such as spraying it through a tower or blowing air through the water, the  $CO_2$  is "stripped" from the water and vented to the atmosphere. The removal of  $CO_2$  forces Reaction (4-8) to shift to the right, which converts more  $H_2CO_3$  to  $CO_2$ . With sufficient aeration, all bicarbonate ( $HCO_3^-$ ), and therefore  $CO_2$ , can be removed.

Similar reactions occur in the anion exchanger. For example, anion resin, which has hydroxide ions at the exchange sites, will react as indicated in the following typical reaction.

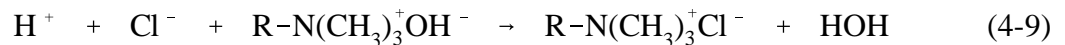

In this pretreatment system, the anion resin is downstream of the cation resin, and the only cations present are hydrogen ions. When the hydroxyl ions are released from the anion exchange sites, they combine with the hydrogen ions to form water. As a result, pure water appears at the effluent (this is somewhat overstated because a very small amount of other cations and anions pass unaffected through the resin columns in actual practice).

Another method sometimes used to remove dissolved gases from water is deaeration. In this process, the water is stored in vented tanks containing electric heaters or steam coils. The water is heated to a temperature sufficient for slow boiling to occur. This boiling strips dissolved gases from the stored water, and these gases are then vented to the atmosphere. Usually, the vented gases are directed through a small condenser to limit the loss of water vapor that would escape as steam along with the gases. This method is particularly effective in removing dissolved oxygen as well as other entrained gases ( $CO_2$ ,  $N_2$ , and Ar).

Removal of dissolved gases from the reactor coolant system is usually accomplished by venting a steam space or high point in the system. In pressurized water reactors (PWR), this is normally accomplished in the pressurizer. The steam space is the high point of the system, and the boiling and condensing action causes a constant stripping of dissolved gases to occur. The steam space is vented either intermittently or constantly, and the gases are carried off in the process.

In addition to the mechanical means mentioned above, the use of scavengers in a PWR prevents the presence of dissolved oxygen. Two methods are normally used in this regard. When facility temperature is above approximately 200°F, gaseous hydrogen is added and maintained in the primary coolant to scavenge oxygen by the following reaction.



The other scavenger is hydrazine ( $\text{N}_2\text{H}_4$ ). Hydrazine is thermally unstable and decomposes at temperatures above 200°F to form ammonia ( $\text{NH}_3$ ), nitrogen ( $\text{N}_2$ ), and hydrogen ( $\text{H}_2$ ). Consequently, the use of hydrazine as an oxygen scavenger is limited to temperatures below 200°F. Hydrazine scavenges oxygen by the following reaction.



The presence of dissolved gases in the steam facility of a PWR is as detrimental as the presence of these gases is in the reactor coolant systems. Because steam facility systems contain metals other than stainless steel, they are even more susceptible to certain types of corrosion in the presence of oxygen and carbon dioxide. Removal of dissolved gases from the steam system is accomplished in two ways: by mechanical means such as air ejectors or mechanical pumps; and by using chemicals that scavenge oxygen.

Because boiling occurs in the steam generators, any dissolved gases entrained in the feedwater will be stripped out during the boiling process. These gases are carried with the steam through the turbines and auxiliary systems and ultimately end up in the condensers. The design of the condensers is such that noncondensable gases (for example,  $\text{O}_2$ ,  $\text{CO}_2$ ) are collected and routed to the air removal system (which consists of air ejectors or mechanical pumps), where they are subsequently discharged to the atmosphere.

Scavenging involves the use of solid additives and volatile chemicals. One commonly-used solid chemical additive is sodium sulfite ( $\text{Na}_2\text{SO}_3$ ). Scavenging of oxygen occurs by the following reaction.



As can be seen by Reaction (4-12), oxygen is consumed in the reaction resulting in the formation of sodium sulfate,  $\text{Na}_2\text{SO}_4$  (a soft sludge). Addition of this scavenging agent is limited to drum-type steam generators. Once Thru Steam Generators (OTSG) do not use this method, but instead use controls that keep all scale-forming chemicals out of the steam generators.



Sodium sulfite reacts rapidly with oxygen and is a very efficient scavenger. However, being a solid and the source of another solid ( $\text{Na}_2\text{SO}_4$ ) that is produced during the reaction, sodium sulfite has the potential of fouling heat transfer surfaces. An additional problem associated with the use of sodium sulfite is corrosion of secondary system components resulting from its decomposition products. At the temperatures present in the steam generators, sodium sulfite can decompose as follows.

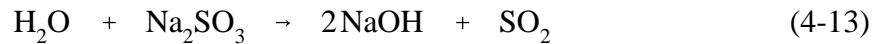

Sulfur dioxide ( $\text{SO}_2$ ) is a gas and is carried over to the remainder of the steam facility. With water (in the steam or in the feed/condensate system), the  $\text{SO}_2$  reacts in the following manner.

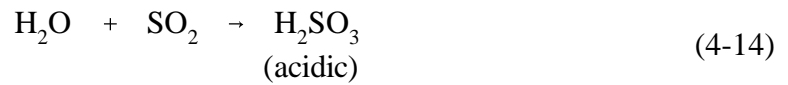

This acidic condition is corrosive to all components in the secondary system.

Because of the problems associated with sodium sulfites, many facilities use volatile chemistry control of the secondary steam system to control dissolved gases in conjunction with air removal systems. This control utilizes hydrazine (Reaction 4-11) and morpholine (Reaction 4-15) to eliminate oxygen and carbon dioxide, respectively.

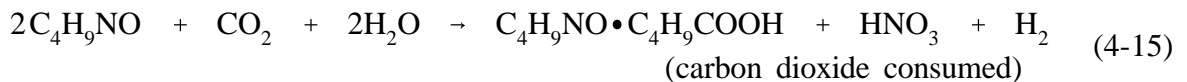
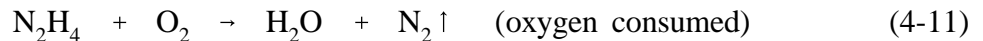

As can be seen by Reaction (4-11), no solids are formed; thus, the tendency of fouling heat transfer surfaces is reduced. An additional benefit results from the decomposition of hydrazine by the following reactions.

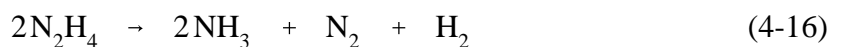

These reactions result in an alkaline pH condition that decreases corrosion in the steam facility. As can be seen in Reaction (4-15), the consumption of  $\text{CO}_2$  takes place. Two benefits result from this reaction; 1) the inventory of dissolved gases in the steam facility is reduced, and 2) is the reaction contributes to maintaining a higher pH by eliminating carbonic acid ( $\text{H}_2\text{CO}_3$ ), thus reducing corrosion.

## Removal of Suspended Solids

Referring back to Figure 5 and examining the effluent of the softener, we find that both sodium salts and precipitates are present. These substances result from reactions that typically occur based on the presence of  $\text{Ca}^{++}$  and  $\text{Mg}^{++}$  salts. The chemicals most commonly used for softening are soda ash or sodium carbonate ( $\text{Na}_2\text{CO}_3$ ) and hydrated lime ( $\text{Ca}(\text{OH})_2$ ). Hard water (water containing  $\text{Ca}^{++}$  and  $\text{Mg}^{++}$  salts) contains calcium and magnesium bicarbonates ( $\text{Ca}(\text{HCO}_3)_2$ ) and ( $\text{Mg}(\text{HCO}_3)_2$ ), as well as calcium sulfate ( $\text{CaSO}_4$ ) and magnesium chloride ( $\text{MgCl}_2$ ). These impurities produce the following reactions.

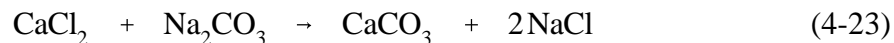
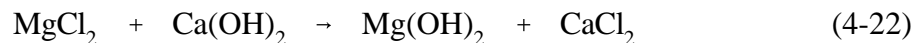
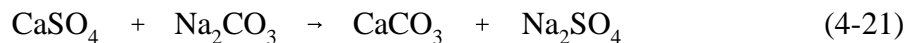
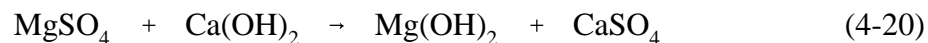

As evident from the above reactions, although  $\text{Ca}^{++}$  and  $\text{Mg}^{++}$  ions can be removed from solution, soluble sodium salts are formed. Consequently the total dissolved solid content is essentially unchanged.  $\text{CaCO}_3$  and  $\text{Mg}(\text{OH})_2$  are in precipitate form and must also be removed from the solution. One method of doing this is by filtration. Filtration is the process in which insoluble solids are removed from the water by passing them through a filter medium consisting of some type of porous material. This process will remove suspended solids and precipitates, but has no effect on dissolved solids. Numerous materials are used as filter media and include sand, activated charcoal, anthracite, diatomaceous earth, and to some extent resin in an ion exchanger. Sand is not normally used in nuclear applications because of the silicate ion ( $\text{SiO}_3^-$ ) associated. Silicate ions are undesirable because they hydrolyze in water and form a weak acid, which tends to increase corrosion. Activated charcoal is often used following a chlorinator in a water treatment system because it removes excess residual chlorine as well as suspended matter.

There are two types of mechanical filters in use, gravity and pressure. Pressure filters are the most widely used because they can be installed in a pressurized system, thereby eliminating the need for additional pumps (gravity filters require pumps to provide a motive force). In addition, in a pressurized filter system, flow rate and other associated parameters can be better controlled.

Another method used for the removal of suspended corrosion products in facility fluid systems is the electromagnetic filter. These are gaining popularity in PWR feed and condensate systems where they have proven effective in reducing the crud loading of these systems, thereby reducing the inventory of corrosion products in steam generators.

Ion exchangers also function as filtration units by virtue of the size of the resin beads and the torturous path the water must follow in passing through the resin. The filtration efficiency, however, is significantly less than the ion exchange efficiency (90% or less for filtration versus approximately 100% for most ion exchange reactions). Filtration efficiency depends largely on the size of the suspended materials, with greater efficiency for the larger particles. Adverse effects of this filtration process are similar to those occurring in other types of filters. In a radioactive system, the buildup of filtered particles (crud) can increase the radiation to prohibitive levels or cause flow reductions that may necessitate removal or backwash of the resin.

## **pH Control**

As discussed in Module 2, in reactor facilities other than those containing aluminum components or using chemical shim, reactor coolant is maintained in an alkaline condition to control corrosion in the system. In practice, if the desired alkaline condition is established, and no other action is taken, the pH gradually decreases during operation of the facility. This is due to factors such as dilution from makeup water additions to compensate for coolant losses caused by sampling, leakage, volume changes on facility cooldown, and reaction of hydroxyl ions ( $\text{OH}^-$ ) with metals and corrosion products. Thus, hydroxyl ions must be added to the coolant to maintain a basic pH. The ion exchange process provides a convenient means of helping to control the pH of reactor coolant by adding  $\text{OH}^-$  ions from the exchange reactions of the resin.

A hydroxyl form anion resin, and a cation resin in some form other than the hydrogen form, may be used for this purpose as in a mixed-bed arrangement, similar to that shown in Figure 3, or in separate cation and anion units where flow is individually controlled. Usually, a portion of the reactor coolant is diverted from its normal path, passes through the ion exchange resin, and then is returned to the main coolant path. In this way, part of the coolant is constantly purified, and in the process hydroxyl ions are released to the coolant. These hydroxyl ions tend to increase the pH (or limit the decrease), thereby offsetting the effects mentioned in the preceding paragraph.

Suppose that the cation resin is in the ammonium form. As reactor coolant passes through the ion exchange system, ionic impurities will be removed and  $\text{NH}_4^+$  and  $\text{OH}^-$  will be added. Thus, the resin serves both to purify the coolant and to help maintain the pH of the coolant by releasing  $\text{NH}_4\text{OH}$ .

The major sources of ionic impurities in reactor coolant are impurities in makeup water and corrosion products. The amount of these impurities in reactor coolant is normally very small; thus, the base added to the coolant by the ion exchange resin is usually not sufficient to entirely compensate for the losses described above. For this reason, the pH of reactor coolant is measured regularly, and additional base is added as needed. The frequency of addition varies considerably with the type of base used.

## **Resin Bed Malfunctions**

The resin beds of ion exchangers are susceptible to malfunction from a number of causes. These causes include channeling, breakthrough, exhaustion, and overheating.

### **Channeling**

Channeling is a condition in which the resin allows a direct flow of water through the ion exchanger. Flow channels are established from the inlet to the outlet of the ion exchanger, which allows water to flow essentially unrestricted through the resin via these paths. If channeling occurs, the water flowing through the resin bed has insufficient contact with the resin beads and results in a decrease in effectiveness of the ion exchanger.

Channeling most often results from improper filling of the ion exchanger with resin. If insufficient water is mixed with the resin when it is added, the resin column may contain pockets, or voids. These voids may then set up flow paths for channeling to occur. Improper design or malfunction of the water inlet connection (flow diffuser) can also lead to channeling.

### **Breakthrough and Exhaustion**

To gain further insight into the processes that occur in a column of mixed bed resin as it removes an impurity, it is worthwhile to construct a series of curves such as those shown in Figure 6. These curves illustrate the behavior of hydrogen form resin as it removes  $\text{NH}_4^+$  ions from solution (the behavior of an anion resin is analogous). The two rows of curves schematically represent the concentrations of  $\text{H}^+$  and  $\text{NH}_4^+$  on the resin and in the effluent (exiting solution).

In the bottom row, concentration is plotted against volume of solution that has passed through the column. That is, the plots represent the concentration of the indicated ion in the effluent solution after a volume of solution has passed through the resin. It is assumed that the concentration of  $\text{NH}_4^+$  in the influent is constant.  $\text{NH}_4^+$  ions are more strongly attracted to the resin than are  $\text{H}^+$  ions. Thus,  $\text{NH}_4^+$  ions readily exchange for  $\text{H}^+$  ions on the resin.

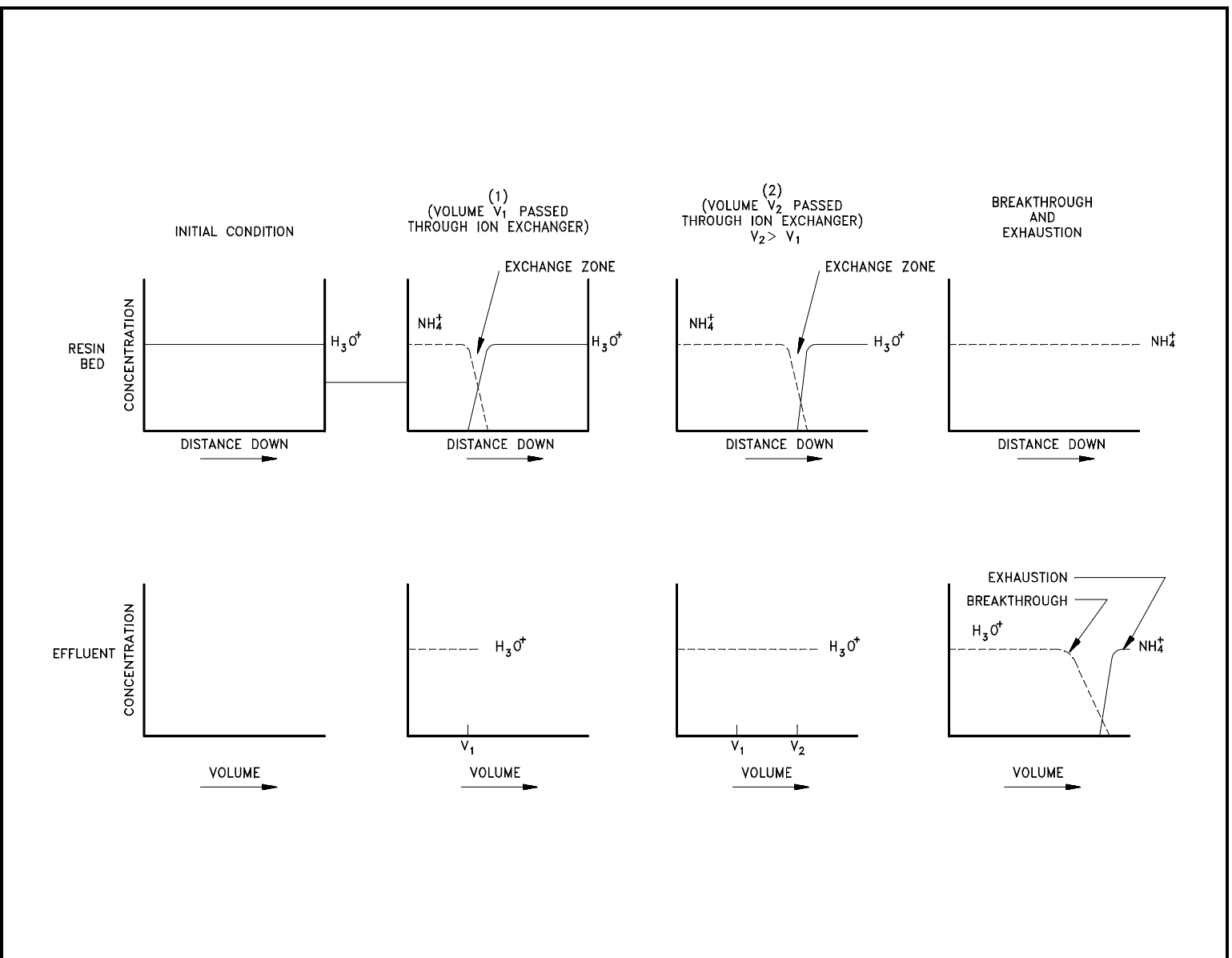

Figure 6 Behavior of Hydrogen Form Cation Exchange Bed as it Removes Ammonium Ions From Solution

As solution passes through the resin column, the relative amounts of ammonium and hydrogen ions on the resin change. The actual exchange process occurs primarily in a relatively narrow band of the column rather than over the entire length. This band is called the exchange zone. Assuming the column is vertical and that solution flows from top to bottom, the resin above the exchange zone is depleted; that is, practically all the exchange capacity has been used. Below the exchange zone, essentially none of the resin's exchange capacity has been used. As more and more solution flows through the column, the exchange zone gradually moves downward as more of the resin is depleted. Eventually, as the exchange zone approaches the end of the column, small amounts of  $\text{NH}_4^+$  begin to appear in the effluent. The point at which this occurs is called breakthrough. If more solution passes through the resin, the concentration of  $\text{NH}_4^+$  in the effluent increases until it is the same as the concentration in the influent. This condition is called exhaustion and indicates that essentially all the exchange capacity of the resin has been used. (Because of the equilibrium nature of the exchange process, a small amount of the resin may remain in the hydrogen form, but not enough to remove any more ionic impurities.) Note that because the exchange zone in this case was narrow, a relatively small volume of solution takes the resin from breakthrough to exhaustion.

### **Resin Overheating**

The potential for elevated temperatures exists during most conditions of facility operation, we will examine in detail the processes that occur if the resin in an ion exchanger is overheated. Although the inert polystyrene basic structure of resin is stable up to fairly high temperatures (approximately 300°F), the active exchange sites are not. The anion resin begins to decompose slowly at about 140°F, and the decomposition becomes rapid above 180°F. The cation resin is stable up to about 250°F. Because these temperatures are well below normal reactor coolant temperatures, the temperature of the coolant must be lowered before it passes through the ion exchange resin.

The anion resin (hydroxyl form) decomposes by either of two mechanisms with approximately equal probability.

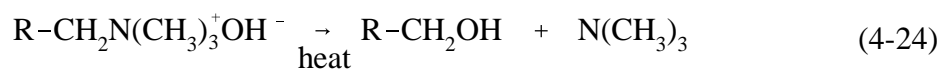

or



Reaction (4-24) produces an alcohol form of the resin, which has no exchange capability, and trimethylamine (TMA),  $N(CH_3)_3$ . TMA is a weak base, similar to ammonia, that reacts with water as follows.

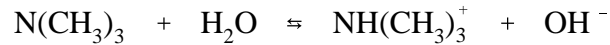

If large amounts of TMA are released to the coolant, the pH may increase noticeably. For example, 1 ppm of TMA in reactor coolant that uses lithium resin will cause a noticeable increase in pH. TMA may also interfere with the analysis for chloride ions (which is routinely performed on reactor coolant) by giving a false indication of high chloride concentration. Another significant property of TMA is its intense odor of dead fish. Although the presence of such an odor from reactor coolant is not definitive for TMA, it may give an indication of resin overheating.

The methyl alcohol ( $CH_3OH$ ) produced by Reaction (4-25) is not expected to have a harmful effect on the reactor coolant system. The other product of this reaction [ $R - CH_2N(CH_3)_2$ ] is an amine with exchange capabilities considerably less than the original form of the resin. Thus, both reactions lead to partial (or complete) loss of exchange capability. If the temperature is sufficiently high, or if a lower temperature (greater than  $180^\circ F$ ) is sustained for a long enough period, the resin will be unfit for use.

Cation exchange resin begins to undergo thermal decomposition at temperatures above about  $250^\circ F$  by the following reaction.

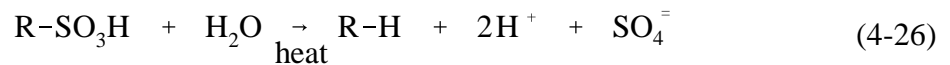

This reaction destroys all exchange capacity of the cation resin and also produces an acid. The Reactions (4-24) through (4-26) are the initial reactions when resin is overheated. If the temperature becomes very high (greater than about  $450^\circ F$ ), the polymeric base structure of the resin will decompose, forming a complex mixture of organic tars and oils.

The preceding discussion concerned the decomposition of resins in their original forms. It should be noted that if overheating occurs after the resin has been in operation for some time, part of the resin will be in a different form due to the exchange process. As a result, some of the previously-removed impurities will be released to the coolant if decomposition occurs. For example, the chloride form of the anion resin will form  $CH_3Cl$  by the reaction corresponding to Reaction (4-25).

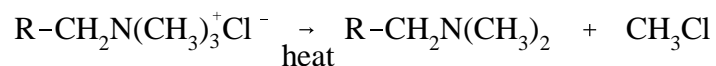

The CH<sub>3</sub>Cl (chloromethane) will be released to the coolant and will decompose in the radiation field of the reactor core, producing Cl<sup>-</sup> ions. Similarly, the sodium form of the cation resin will release Na<sup>+</sup> ions by the following reactions.

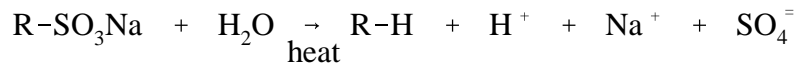

A number of changes are probable if overheating of resin occurs. Reactor coolant Cl<sup>-</sup> levels would probably increase as a result of thermal breakdown and subsequent release. Ion exchanger effectiveness would be greatly reduced for similar reasons. Radioactivity levels of the reactor coolant would increase because of the release of impurities collected and later released from the resin. pH would likely decrease because of the release of H<sup>+</sup> ions from the cation resin complex and may cause acidic conditions of the reactor coolant if the temperature were sufficient (>250°F). Because the anion resin decomposes at lower temperatures, pH may increase as a result of the release of TMA and be accompanied by a dead fish odor. Because of the consequences of overheated resin, stringent temperature limitations are necessary. If overheating occurs, the ion exchanger should be taken out of service immediately and the cause rectified. The resin must be replaced prior to placing the ion exchanger back in service after overheating.

## **Summary**

The important information in this chapter is summarized below.

### **Dissolved Gases, Suspended Solids And pH Control Summary**

- Because of the presence of impurities, raw water sources undergo treatment prior to use as makeup water in reactor facility systems. These systems normally utilize several distinct processes that remove solids, ionic impurities, and gases. Pretreatment of makeup water is necessary to reduce corrosion, minimize radiation, and limit fouling of heat transfer surfaces.
- If the hydrogen and hydroxyl forms of resin are used, the result is pure, neutral water. Other forms may be used to remove unwanted impurities from solution and substitute another substance, such as a base, to help control pH. Resins also filter solids suspended in a solution, but the efficiency for this is usually less than the efficiency for removal by ion exchange.



### **Dissolved Gases, Suspended Solids And pH Control Summary (Cont.)**

- Dissolved gases are removed from reactor facility systems to limit corrosion by any one of the following methods or combinations of methods:

Aeration - The spraying of the water to physically release the entrained gasses, then venting the gas.

Deaeration - The heating of the water to a slow boil, then vents the gas usually to a condenser so the moisture is not lost.

Addition of scavengers - Examples are hydrogen, hydrazine, and morpholine, the scavenger combines with the gas and removes it chemically.

- Channeling in an ion exchanger occurs when there is a direct flowpath for the water that decreases the resin-water contact. Channeling may occur in the resin bed as a result of improper filling or malfunction of the inlet connection.
- Resins are susceptible to damage by overheating. Although a resin contains a very large number of exchange sites, the number is finite and the resin exchange capability is eventually depleted. The first indication of depletion is breakthrough, which occurs when impurity ions begin to appear in the solution after it has passed through the resin.
- When the concentration of impurities is the same before and after the solution passes through the resin, the resin has reached a state of exhaustion.
- Suspended solids are removed by the use of mechanical filters. The two basic categories of mechanical filters are gravity flow and pressure flow filters. The pressure flow filters are more likely to be used because there are better control capabilities. Numerous materials are used as filter media and include sand, activated charcoal, anthracite, diatomaceous earth, and to some extent the resin in an ion exchanger

## WATER PURITY

*The fewer the contaminants in water, the less corrosion takes place. The methods of water treatment have been explored previously. This chapter discusses how water purity is quantified. Measuring the purity helps to keep treatment effective.*

**EO 1.10 LIST the maximum conductivity and approximate concentration of electrolyte for each level of purity for makeup water.**

### Water Purity

The water used in a nuclear facility must be of a purity level that is consistent with the overall objectives of chemistry control in the facility.

There are a number of ways in which pure water is obtained, including distillation systems and pretreatment systems similar to those mentioned earlier in this module. Regardless of the method employed, the required purity must be achieved.

Water purity has been defined in many different ways, but one generally accepted definition states that high purity water is water that has been distilled and/or de-ionized so that it will have a specific resistance of 500,000 ohms (2.0 micromhos conductivity) or greater. This definition is satisfactory as a base to work from, but for more critical requirements, the breakdown shown in Table 3 has been suggested to express degrees of purity.

<b>TABLE 3 Water Purity</b>		
Degree of Purity	Maximum Conductivity ( $\mu$ mhos/cm)	Approximate Concentration of Electrolyte, mg/l
Pure	10	2 - 5
Very Pure	1	0.2 - 0.5
Ultrapure	0.1	0.01 - 0.02
Theoretically Pure	0.054	0.00

Conductivity is a measure of the ease with which electricity can be passed through a substance. The presence of ions greatly facilitates the passage of an electric current. Pure water is only slightly ionized by the dissociation of water:  $\text{H}_2\text{O} \rightarrow \text{H}^+ + \text{OH}^-$ . At 25°C, the concentration of the hydrogen and hydroxyl ions is  $10^{-7}$  moles/liter.

The equivalent conductance of hydrogen (H) is

$$350 \frac{\text{mhos-cm}^2}{\text{equivalent}}$$

and the equivalent conductance of OH is

$$192 \frac{\text{mhos-cm}^2}{\text{equivalent.}}$$

A mho is a measure of the ease with which electric current will pass and is the inverse of an ohm, the measure of resistance to the passage of electric current. Conductance and conductivity are similar qualities (conductivity is measured in  $\mu\text{mhos/cm}$ , so conductance must be converted to conductivity). A  $\mu\text{mho}$  is one millionth of a mho. The total conductivity of pure water can be calculated by adding the equivalent conductances of H and OH, multiplying by the normality (see Module 1 for definition), and then multiplying by  $10^{-3}$  l/cm<sup>3</sup> and  $10^6$   $\mu\text{mhos/mho}$ . For theoretically pure water this becomes the following.

$$(350 + 192) \frac{\text{mhos-cm}^2}{\text{equiv}} \times 10^{-7} \frac{\text{equiv}}{\text{liter}} \times 10^{-3} \frac{\text{liters}}{\text{cm}^3} \times 10^6 \frac{\mu\text{mhos}}{\text{mho}} = .054 \frac{\mu\text{mho}}{\text{cm}}$$

The conductivity limit for demineralized water is 1  $\mu\text{mho/cm}$ .

Conductivity will very quickly indicate the presence of any ionic impurities, even if the impurity concentration is extremely small. As an example, suppose 1.0 mg of NaCl impurity were deposited in 1 liter of demineralized water. The normality of this solution would be as follows.

$$1 \times 10^{-3} \frac{\text{gm}}{\text{liter}} \times \frac{1 \text{ equivalent}}{58 \text{ gm}} = \frac{1}{58} \times 10^{-3} \frac{\text{equivalent}}{\text{liter}} = 1.7 \times 10^{-5} \frac{\text{equivalent}}{\text{liter}}$$

The equivalent conductance of  $\text{Na}^+$  is  $51 \frac{\text{mhos} \cdot \text{cm}^2}{\text{equivalent}}$ , while the equivalent conductance of  $\text{Cl}^-$  is  $75 \frac{\text{mhos} \cdot \text{cm}^2}{\text{equivalent}}$ . The conductivity of the solution is

$$(51 + 75) \frac{\text{mhos} \cdot \text{cm}^2}{\text{equivalent}} \times 1.7 \times 10^{-5} \frac{\text{equivalent}}{\text{liter}} \times 10^{-3} \frac{\text{liter}}{\text{cm}} \times 10^6 \frac{\mu\text{mho}}{\text{mho}} = 2.2 \frac{\mu\text{mho}}{\text{cm}},$$

which is well above the limit. Even extremely low concentrations of ionic impurities can easily be detected. The most probable cause is a depleted or damaged resin bed that is no longer capable of removing ionic contaminants. The depleted bed should be removed from service, and a fresh resin bed placed in service.

For most applications in nuclear facilities, the specification that is identified as Very Pure ( $1.0 \mu\text{mho}/\text{cm}$  maximum conductivity) is used. Ultra Pure demineralized water is normally only required in laboratory situations and is mentioned for information purposes only.

## **Summary**

The important information in this chapter is summarized below.

<b>Water Purity Summary</b>		
Water Purity is clarified below.		
<u>Degree of Purity</u>	<u>Maximum Conductivity(<math>\mu\text{mhos}/\text{cm}</math>)</u>	<u>Approximate Concentration of Electrolyte, mg/l</u>
Pure	10	2 - 5
Very Pure	1	0.2 - 0.5
Ultrapure	0.1	0.01 - 0.02
Theoretically Pure	0.054	0.00