



*An Online PDH Course
brought to you by
CEDengineering.com*

Industrial Heat Pumps for Steam and Fuel Savings

Course No: D01-001

Credit: 1 PDH

Steven Liescheidt, P.E., CCS, CCPR



Continuing Education and Development, Inc.

P: (877) 322-5800

info@cedengineering.com

www.cedengineering.com



Industrial Technologies Program

Boosting the productivity and competitiveness of U.S. industry through improvements in energy and environmental performance



A Best Practices Steam Technical Brief



Industrial Heat Pumps for Steam and Fuel Savings

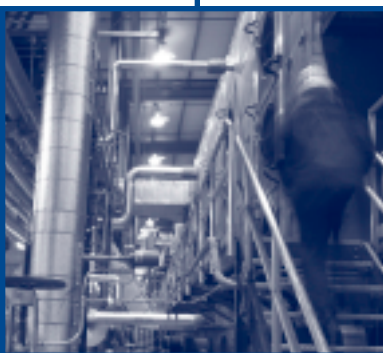

U.S. Department of Energy
Energy Efficiency and Renewable Energy

Bringing you a prosperous future where energy is clean, abundant, reliable, and affordable

Industrial Heat Pumps for Steam and Fuel Savings

Industrial heat pumps are a class of active heat-recovery equipment that allows the temperature of a waste-heat stream to be increased to a higher, more useful temperature. Consequently, heat pumps can facilitate energy savings when conventional passive-heat recovery is not possible.

The purpose of this Steam Technical Brief is to introduce heat-pump technology and its application in industrial processes. The focus is on the most common applications, with guidelines for initial identification and evaluation of the opportunities being provided.

1.0 INTRODUCTION TO HEAT PUMPS

A heat pump is a device that can increase the temperature of a waste-heat source to a temperature where the waste heat becomes useful. The waste heat can then replace purchased energy and reduce energy costs.

However, the increase in temperature is not achieved without cost. A heat pump requires an external mechanical- or thermal-energy source. The goal is to design a system in which the benefits of using the heat-pumped waste heat exceed the cost of driving the heat pump.

Several heat-pump types exist; some require external mechanical work and some require external thermal energy. For the purpose of discussing basic heat-pump characteristics, this brief will first introduce the mechanical variety, and then address the thermal types.

1.1 Why can a heat pump save money?

Heat pumps use waste heat that would otherwise be rejected to the environment; they increase air temperature to a more effective level. Heat pumps can deliver heat for less money than the cost of fuel.

Heat pumps operate on a thermodynamic principle known as the Carnot Cycle. To aid understanding of this cycle, it is helpful to contrast the Carnot Cycle with the more familiar thermodynamic cycle that underlies the operation of steam turbines, the Rankine Cycle.

Degrading high-grade thermal energy into lower-grade thermal energy creates shaft work, or power, in the Rankine Cycle. In a steam turbine, this is accomplished by supplying high-pressure steam and exhausting lower-pressure steam.

In contrast, mechanical heat pumps operate in the opposite manner. They convert lower-temperature waste heat into useful, higher-temperature heat, while consuming shaft work (Figure 1.1).

The work required to drive a heat pump depends on how much the temperature of the waste heat is increased; in contrast, a steam turbine produces increasing amounts of work as the pressure range over which it operates increases.

Heat pumps consume energy to increase the temperature of waste heat and ultimately reduce the use of purchased steam or fuel. Consequently, the economic value of purchasing a heat pump depends on the relative costs of the energy types that are consumed and saved.

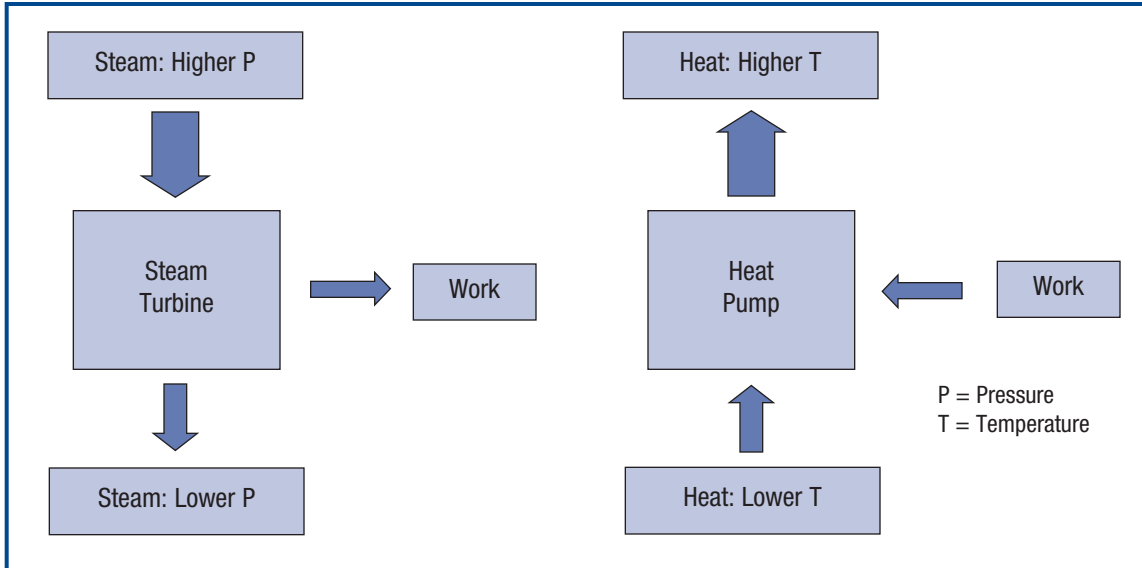

Figure 1.1: Comparison of Steam-Turbine and Heat-Pump Operating Principles

1.2 How does a heat pump work, and how much energy can it save?

Several types of heat pumps exist, but all heat pumps perform the same three basic functions:

- Receipt of heat from the waste-heat source
- Increase of the waste-heat temperature
- Delivery of the useful heat at the elevated temperature.

One of the more common heat pump types, the mechanical heat pump, will be used to show how these functions work (Figure 1.2).

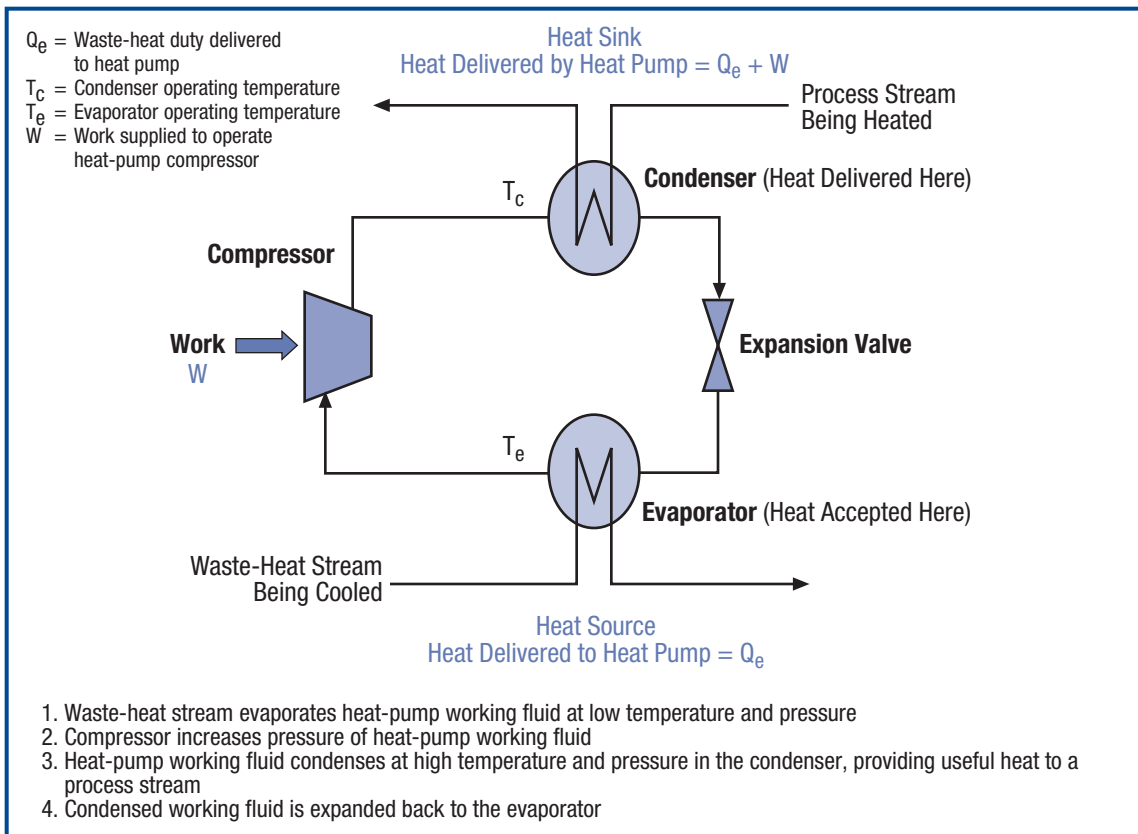

Figure 1.2: Simple Schematic of Mechanically Driven Heat Pump

Waste heat is delivered to the heat-pump evaporator in which the heat-pump working fluid is vaporized. The compressor increases the pressure of the working fluid, which in turn increases the condensing temperature. The working fluid condenses in the condenser, delivering high-temperature heat to the process stream that is being heated.

A key parameter influencing the savings that a heat pump achieves is the temperature lift realized in the heat pump. Temperature lift is the difference between the evaporator and condenser temperatures.

Figure 1.3 illustrates how the cost of heat delivered by an electric-motor-driven mechanical heat pump depends on the cost of electric power and on the temperature lift that the heat pump achieves.

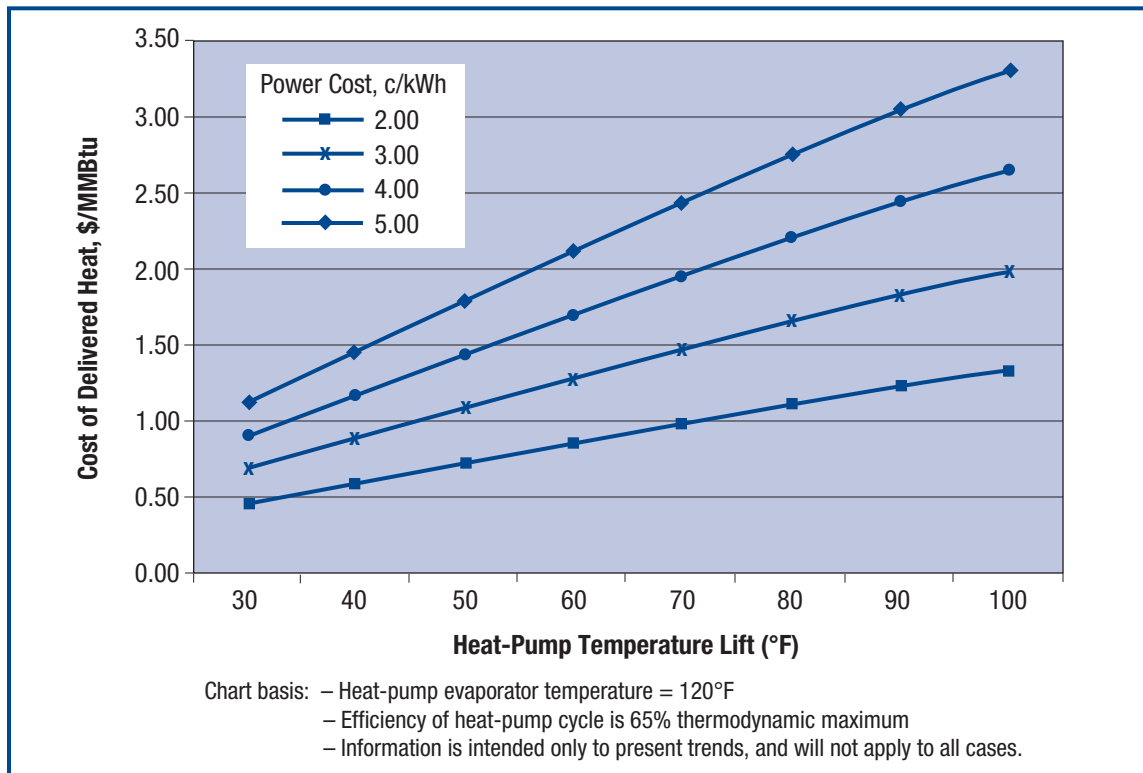

Figure 1.3: Comparison of Cost of Heat Delivered

For example, if natural gas costs \$3.00/million British thermal units (MMBtu), the cost of delivering heat from fuel at 80% efficiency will be \$3.75/MMBtu. Figure 1.3 shows that the effective cost of heat supplied by the heat pump is lower than the cost of purchased fuel that otherwise would be consumed. However, this advantage erodes as the temperature lift increases, because more work is required to obtain the higher lifts. Also, because electricity is the work source for this heat pump, lower power costs result in greater benefits.

Under the right circumstances, a heat pump can reduce energy costs and provide an attractive cost-reduction project, particularly when:

- The heat output is at a temperature where it can replace purchased energy such as boiler steam or gas firing
- The cost of energy to operate the heat pump is less than the value of the energy saved
- The net operating cost savings (reduction in purchased energy minus operating cost) is sufficient to pay back the capital investment in an acceptable time period.

For industrial applications, simple paybacks of 2 to 5 years are typical. Different types of heat pumps accomplish the three basic heat-pump functions in different ways, but in all cases the goal is

the same: recover waste heat, increase its temperature, and deliver it at a higher, more useful, temperature for a reduced cost compared to the alternative. The common variants are described below.

1.3 Common types of industrial heat pumps

A brief description of the most common types of heat pumps and their key operating principles is provided below.

Closed-Cycle Mechanical Heat Pumps use mechanical compression of a working fluid to achieve temperature lift. The working fluid is typically a common refrigerant. Most common mechanical drives are suitable for heat-pump use; examples include electric motors, steam turbines, combustion engines, and combustion turbines.

Open-Cycle Mechanical Vapor Compression (MVC) Heat Pumps use a mechanical compressor to increase the pressure of waste vapor. Typically used in evaporators, the working fluid is water vapor. MVC heat pumps are considered to be open cycle because the working fluid is a process stream. Most common mechanical drives are suitable for heat-pump use; examples include electric motors, steam turbines, combustion engines, and combustion turbines.

Open-Cycle Thermocompression Heat Pumps use energy in high-pressure motive steam to increase the pressure of waste vapor using a jet-ejector device. Typically used in evaporators, the working fluid is steam. As with the MVC Heat Pump, thermocompression heat pumps are open cycle.

Closed-Cycle Absorption Heat Pumps use a two-component working fluid and the principles of boiling-point elevation and heat of absorption to achieve temperature lift and to deliver heat at higher temperatures. The operating principle is the same as that used in steam-heated absorption chillers that use a Lithium Bromide/water mixture as their working fluid.

Key features of absorption systems are that they can deliver a much higher temperature lift than the other systems, their energy performance does not decline steeply at higher temperature lift, and they can be customized for combined heating and cooling applications.

Four heat exchangers—an evaporator, condenser, generator, and absorber—are found in a typical absorption heat pump (Figure 1.4). High-temperature prime energy (steam or fuel) is supplied to the desorber, where vapor is boiled out of the working fluid at high pressure. The high-pressure vapor is condensed in the condenser, where the heat is recovered into a process stream. High-pressure condensate from the condenser is throttled to a lower pressure in the evaporator, where the waste heat is recovered to vaporize the low-pressure condensate. In the absorber, concentrated working fluid from the desorber contacts low-pressure vapor from the evaporator, creating heat that is recovered into a process stream. The working fluid returns to the desorber to complete the cycle.

In a typical absorption heat-pumping application, waste heat at low temperature is delivered to the evaporator, and prime heat at high temperature is delivered to the generator. An amount of heat equivalent to the sum of the high- and low-temperature heat inputs can be recovered at an intermediate temperature via the condenser and absorber. This is analogous to the thermocompression heat pump, in which high-pressure steam is used to increase or lift low-pressure waste vapor to a higher pressure and temperature. However, in the case of the high-lift absorption heat pump, the temperature lift can be 200 to 300° F, rather than the 20 to 50° F of the thermocompression system.

An important variation of the Type-1 Absorption Heat Pump is obtained by selecting operating parameters so that the device effects chilling at the ‘cold-end’ of the cycle while delivering hot water. The ability to provide simultaneous cooling and heating provides additional benefits over a ‘heating-only’ heat pump and improves the economics of an installation.

An alternate configuration for an absorption heat pump allows a medium-temperature waste-heat stream to split into one higher-temperature stream and one lower-temperature stream. Adjusting the operating pressures and working-fluid concentrations accomplishes this reconfiguration.

Figure 1.5 illustrates the energy balances for Type-1 and Type-2 absorption systems.

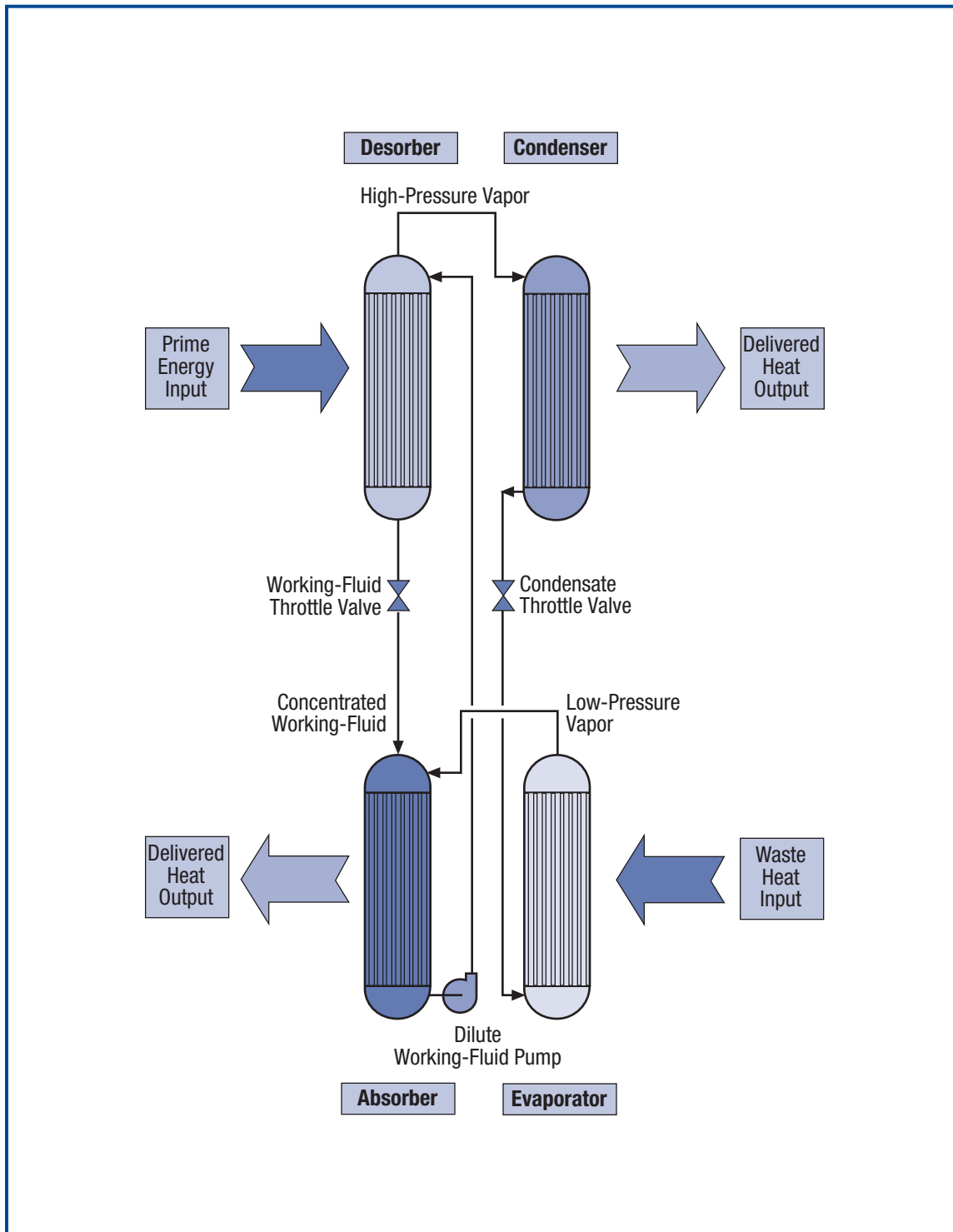

Figure 1.4: Simplified Schematic of an Absorption Heat Pump

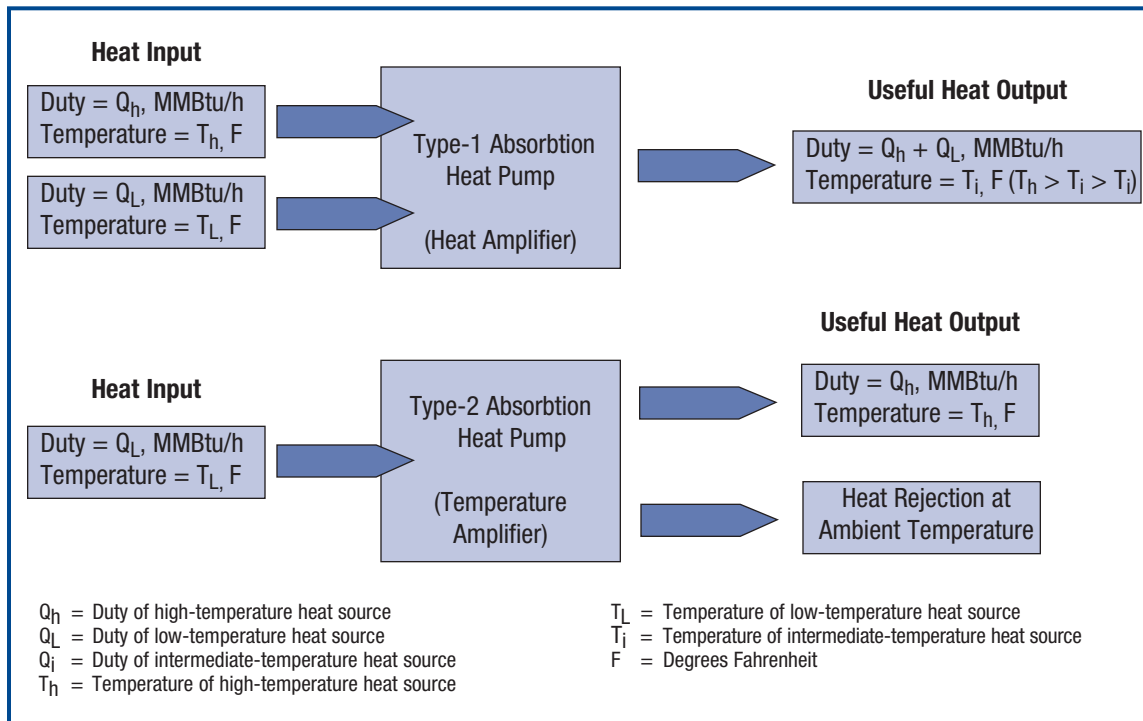

Figure 1.5: Simplified Energy Balances for Absorption Heat Pumps

2.0 INDUSTRIAL APPLICATIONS

2.1 Which applications use heat pumps?

Table 1 provides a representative overview of heat-pump applications in industrial processes. The table is not comprehensive, but highlights the most common industrial applications and heat-pump types.

The most common industrial application of heat pumping is dehumidification drying of lumber. In this application, warm, humid exhaust air from a lumber-drying kiln is the heat source for a closed-cycle mechanical heat pump that delivers heat to the incoming air. In addition to energy benefits, the lower operating temperature of heat-pumped kilns improves product quality; the heat pump removing VOCs from the exhaust also provides an environmental benefit.

While lumber-drying applications are numerous, the size of the units is usually small in terms of the heat delivered. For example, 150,000 Btu/h heat output would be considered a large application; however, industry is developing larger systems of 3 to 5 MMBtu/h.

Closed-cycle applications that are not for lumber drying range from 1 to 20 MMBtu/h heat output, and typically heat streams, such as process liquids or air.

The most common large-heat-load application is vapor compression evaporation. In this application, evaporated vapor is compressed over a small pressure range and condensed to provide the energy to drive the evaporation process. Such systems deliver 20 MMBtu/h to over 100 MMBtu/h at a low cost.

Evaporators and flash-steam recovery systems frequently incorporate thermocompression systems. For example, paper dryers commonly use thermocompressors to recover flash steam from dryer condensate.

Absorption systems are commonly used in chilling applications as alternatives to mechanical chillers, rather than in heat-pumping applications.

Table 1. Representative Overview of Heat-Pump Applications in Industrial Manufacturing Activities

Industry	Manufacturing Activity	Process	Heat-Pump Type
Petroleum Refining and Petrochemicals	Distillation of petroleum and petrochemical products	Separation of propane/propylene, butane/butylene and ethane/ethylene	Mechanical Vapor Compression, Open cycle
Chemicals	Inorganic salt manufacture including salt, sodium sulfate, sodium carbonate, boric acid	Concentration of product salt solutions	Mechanical Vapor Compression, Open cycle
	Treatment of process effluent	Concentration of waste streams to reduce hydraulic load on waste treatment facilities	Mechanical Vapor Compression, Open cycle
	Heat recovery	Compression of low-pressure waste steam or vapor for use as a heating medium	Mechanical Vapor Compression, Open cycle
	Pharmaceuticals	Process water heating	Mechanical Compression, Closed cycle
Wood Products	Pulp manufacturing	Concentration of black liquor	Mechanical Vapor Compression, Open cycle
	Paper manufacturing	Process water heating	Mechanical compression, Closed cycle
	Paper manufacturing	Flash-steam recovery	Thermocompression, Open cycle
	Lumber manufacturing	Product drying	Mechanical Compression, Closed cycle
Food and Beverage	Manufacturing of alcohol	Concentration of waste liquids	Mechanical Vapor Compression, Open cycle
	Beer brewing	Concentration of waste beer	Mechanical Vapor Compression, Open cycle
	Wet corn milling/corn syrup manufacturing	Concentration of steep water and syrup	Mechanical Vapor Compression, Open cycle Thermocompression, Open cycle
	Sugar refining	Concentration of sugar solution	Mechanical Vapor Compression, Open cycle Thermocompression, Open cycle
	Dairy products	Concentration of milk and of whey	Mechanical Vapor Compression, Open cycle Thermocompression, Open cycle
	Juice manufacturing	Juice concentration	Mechanical Vapor Compression, Open cycle
	General food-product manufacturing	Heating of process and cleaning water	Mechanical Compression, Closed cycle
	Soft drink manufacturing	Concentration of effluent	Mechanical Compression, Closed cycle
Utilities	Nuclear power	Concentration of radioactive waste	Mechanical Vapor Compression, Open cycle
		Concentration of cooling tower blowdown	Mechanical Vapor Compression, Open cycle
Miscellaneous	Manufacturing of drinking water	Desalination of sea water	Mechanical Vapor Compression, Open cycle
	Steam-stripping of waste water or process streams	Flash steam recovery	Thermocompression, Open cycle
	Electroplating industries	Heating of process solutions	Mechanical Compression, Closed cycle
		Concentration of effluent	Mechanical Vapor Compression, Open cycle
	Textiles	Process and wash-water heating	Mechanical Compression, Closed cycle
		Space heating	Mechanical Compression, Closed cycle
		Concentration of dilute dope stream	Mechanical Compression, Closed cycle
	General manufacturing	Process and wash-water heating	Mechanical Compression, Closed cycle
		Space heating	Mechanical Compression, Closed cycle
	District heating	Large-scale space heating	Mechanical Compression, Absorption Closed cycle
Solvent recovery	Removal of solvent from air streams	Mechanical Compression, Open cycle	

2.2 Examples of heat-pump applications and types

Descriptions of a few of the most common heat-pump applications can help illustrate how heat pumps are integrated into process operations.

2.2.1 Lumber Drying—Closed-Cycle Mechanical

Lumber drying is accomplished by supplying heated air to stacked lumber in an enclosed room. In a steam-heated lumber kiln, fresh air is heated and supplied to the kiln shown in Figure 2.1a. The hot air evaporates moisture from the lumber and returns to the atmosphere.

Figure 2.1b shows how a closed-cycle mechanical heat pump is used for lumber drying. The moist kiln exhaust air is passed over the heat-pump evaporator, cooling the exhaust and producing some moisture condensation. The compressed heat-pump working fluid condenses against incoming fresh air, supplying hot air to the dryer. The cost of power to drive the heat pump is much less than the cost of using steam in the kiln without the heat pump.

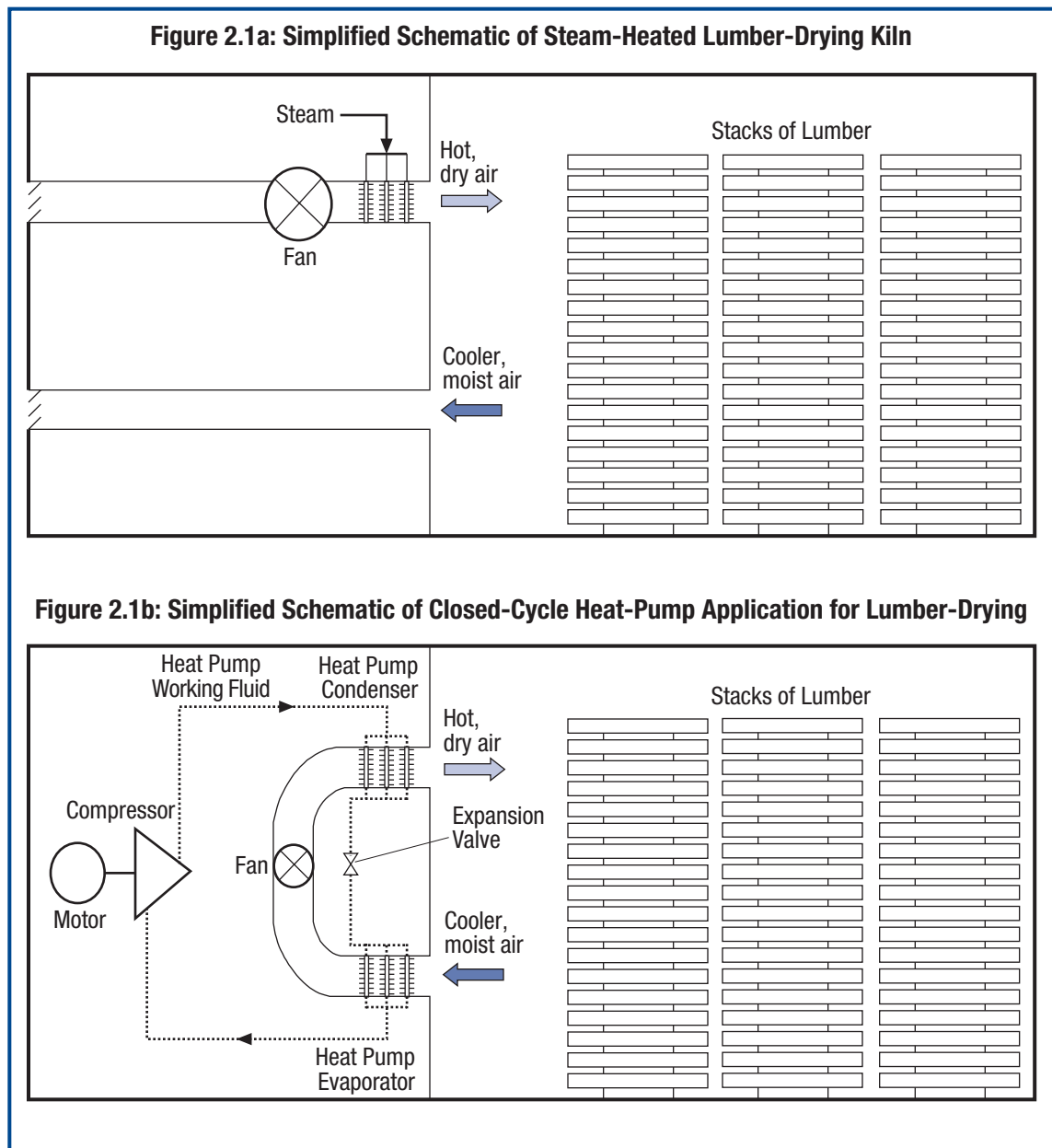

Figure 2.1: Typical Examples of Steam Heat Used In Lumber-Drying Applications

2.2.2 Evaporation—Open-Cycle Mechanical Vapor Compression (MVC) for Sugar Solution Concentration

In the sugar refining process, large amounts of water must be evaporated from sugar solution before final crystallization. Figure 2.2 shows how MVC evaporation compares to multi-effect evaporation.

In multi-effect evaporation, steam is supplied to the first effect of the evaporator to boil off some water and create vapor. The vapor flows to an exchanger in the next effect, which operates at a lower pressure because a vacuum is applied. Here, additional water is evaporated; this process is repeated in each effect.

In an MVC evaporator, compressed vapor leaving the compressor condenses against the liquid being evaporated; the vapor it creates flows to the compressor inlet. The compression sufficiently increases the vapor pressure and allows vapor condensation at a temperature high enough to boil the incoming liquid.

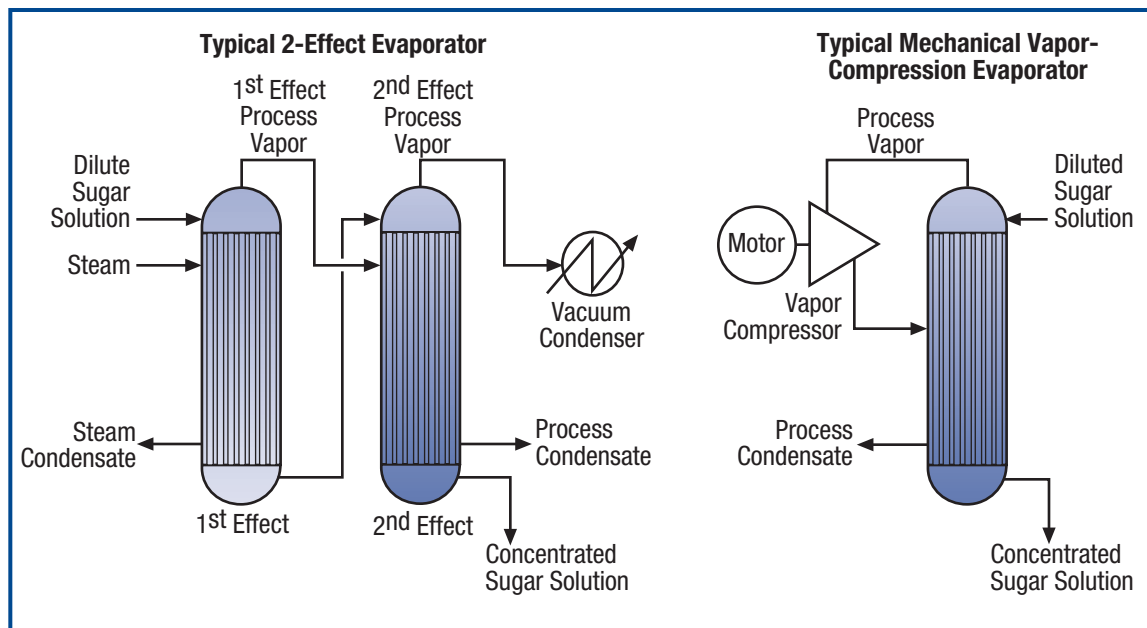

Figure 2.2: Mechanical Compression Heat-Pump Application in Evaporation Process

The cost to drive the mechanical compression evaporator is less than the cost of the steam that drives the multi-effect evaporator.

However, energy cost is not the only consideration in evaporator selection. A thorough evaluation of all the benefits and drawbacks of each evaporator type would be necessary before selecting an evaporator for a specific application.

2.2.3 Thermocompression—Paper-Dryer Flash-Steam Recovery

A thermocompression heat pump is similar to the mechanical compression heat pump in that vapor is compressed so that it condenses at a higher pressure and temperature. However, instead of using mechanical work as the means of compression, a thermocompressor uses energy gained from reducing the pressure of higher-pressure steam.

The use of a thermocompressor for recovery of flash steam in a paper dryer is shown in Figure 2.3. In a paper machine, steam reaches each section of drying drums at the correct pressure to achieve required drying conditions. Steam condensate from higher-pressure sections is flashed to lower pressures; it is then recompressed to maximize energy recovery from the steam condensate, and to improve dryer energy efficiency.

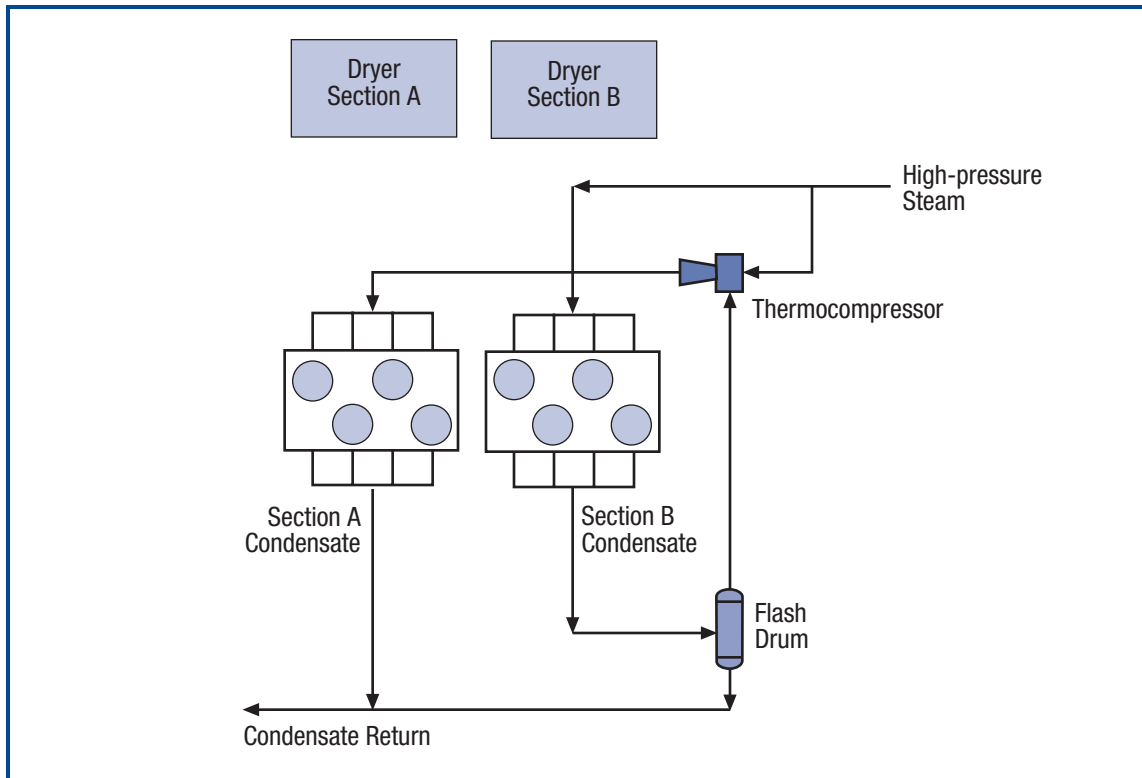

Figure 2.3: Thermocompression Heat-Pump Application in a Paper Dryer

3.0 HEAT-PUMP EVALUATION

Heat pump evaluation consists of four steps:

- Determining if a heat pump is a potential fit with your heat-recovery application
- Making an initial selection of heat-pump type
- Conducting preliminary cost/benefit analysis
- Performing a detailed feasibility study to define benefits and cost with sufficient confidence to move forward with the implementation.

The information below provides assistance in working through these four steps.

3.1 When is a heat pump applicable?

Plant personnel can explore a few questions to determine if a heat pump might be applicable in their facility:

- Where is heat available from the process?
- Where is heat required in the process?
- What is the value of saved energy?
- Will the facility gain non-energy benefits such as environmental improvements or product quality?

The tables that follow provide some positive and negative indicators for heat-pump applicability. These tables provide qualitative guidance on likely heat-pump feasibility. For example, if a reviewer can associate the process and site in question with more favorable features than unfavorable, then it is worth proceeding with further consideration. If unfavorable features predominate, then facility personnel should re-evaluate the basis for considering a heat pump before proceeding.

Table 3.1 Features Favorable for Heat-Pump Installations

Features Favorable for Heat Pump Installation		Reason
Process Features		
1	The process involves evaporation	Opportunity for highly effective heat pump
2	There are streams in the 160 to 220° F temperature range that are cooled or sent to drain	Heat in this temperature range is hot enough to not require too much lift to make it useful
3	Water, air or other process streams are heated from ambient to 150 to 250° F with steam or fuel	Heat pumps can easily supply heat in this temperature range
4	Low-pressure steam is vented or condensed	Condensing steam is a convenient heat source that a heat pump can easily use
5	The process involves distillation with a small temperature range between the reboiler and condenser	Opportunity for highly effective heat pump because of low heat-pump temperature lift
6	The amount of recoverable waste heat available exceeds about 0.5 MMBtu/h	The potential savings have to be large enough to generate interest in a project; economies of scale favor larger installations
7	The heat source is a clean liquid or condensing fluid	Heat capture into the heat pump is simple
8	The process entails continuous operation with a high number of operating hours	Project generates more annual savings
Energy Costs		
1	Electricity is cheap <i>relative</i> to fuel. For example the ratio of electricity cost to fuel cost on a Btu basis is < 3.	Reduces the effective cost of heat delivered by the heat pump
2	Both fuel and power prices are high (this is negative in general, but is a benefit in conservation efforts)	Higher energy prices increase the value of cost savings relative to capital cost; this improves payback
Utility System Features		
1	Reducing use of heating steam, or use of fuel for process heating, does not affect on-site power generation	Usually results in better economics

Table 3.2 Features Unfavorable for Heat-Pump Installations

Features Unfavorable for Heat Pump Installation		Reason
Process Features		
1	Heat is available at less than 200° F, but the processes need heat at over 250° F, indicating a high-temperature lift of over 50° F	A high-temperature lift requirement is not automatically a drawback. However, high temperature lifts increase the effective cost of heat that a mechanical heat pump delivers, and reduces savings. Alternately, a high-lift requirement indicates use of an absorption heat pump, which often have a higher first-cost than mechanical types.
2	Waste heat is available from cooling a small stream	A waste-heat stream may appear useful if it is available at a reasonably high temperature, but if it is a low-flow stream and cools down quickly, the heat pump will increase lift to compensate. This leads to reduced savings
3	Additional maintenance costs	Additional equipment, particularly rotating equipment, leads to additional maintenance costs which offset the benefits
Energy Costs		
1	Electricity is expensive <i>relative</i> to fuel. For example the ratio of electricity cost to fuel cost on a Btu basis is > 6.	Increases the effective cost of heat delivered by a mechanical heat pump
2	Both fuel and power prices are low (a benefit in general, but negative for energy conservation efforts)	Lower dollar value of energy cost savings reduces incentive for conservation
Utility System Features		
1	Reducing use of heating steam, or use of fuel for heating, affects on-site power generation	If a heat pump affects on-site power generation, the impact on power purchase must be considered, because it usually reduces savings.

3.2 Initial selection of heat-pump type

Having established that a heat pump may be applicable, it is time to select a heat-pump type. Choosing a heat pump has a direct influence on capital and operating costs. The type of heat pump typically employed depends on:

- The nature of the heat source (for example, liquid, gas, condensing vapor)
- The nature of the heat sink (for example, liquid, gas, boiling fluid)
- The required temperature lift (temperature difference between the heat input and heat rejection temperatures).

Table 3.3 provides guidelines for selecting heat-pump type. Section 1.3 provides a description of the major components and equipment configuration.

Table 3.3 Guidelines for Selecting Heat-Pump Type

Temperature Lift	Heat-Source Type	Heat-Sink Type	Suggested Heat-Pump Type
< 100° F	– Sensible cooling of liquid	– Sensible heating of gas or liquid – Boiling liquid	1. Closed-cycle mechanical 2. Absorption (lithium bromide/water)
	– Partial condensation of liquid from vapor stream	– Sensible heating of gas or liquid – Boiling liquid	1. Closed-cycle mechanical 2. Absorption (with lithium bromide/water working fluid)
	– Condensing steam	– Evaporation of water	1. Open-cycle mechanical (single-stage compressor) 2. Thermocompression
	– Condensing vapor (steam or other)	– Boiling liquid – Sensible heating of gas or liquid	1. Semi-open-cycle mechanical (single-stage compressor)
> 100° F	– All heat sources (except steam)	– All heat sinks (except steam)	1. Absorption (with high lift working fluid) 2. Multistage mechanical compression
	– LP steam	– Higher-pressure steam header	1. Open-cycle mechanical 2. Absorption (with high lift working fluid) 3. Multistage mechanical compression

The primary purpose of these guidelines is to provide a starting point for subsequent evaluations of operating costs, savings, and capital cost. Several heat-pump types might be suitable for a given application with the final choice, depending on the economic evaluations.

The vast majority of heat pumps operate with temperature lifts of less than 100° F. This brief includes information for high-lift applications to help indicate the difference in equipment requirements needed to obtain high lifts.

3.3 Estimating Savings

For any energy savings project, the basic goal in estimating savings in operating costs is to establish the difference in costs between current and future case-base operation.

For passive-heat recovery projects, establishing this cost difference is relatively simple, because the value of steam or fuel saved is readily calculated.

In the case of heat pumps, the energy savings is equal to the value of steam or fuel saved, minus the cost of operating the heat pump. The quantity of energy saved and the cost of operating the heat pump depend on the application and the heat-pump characteristics.

The example that follows illustrates the steps involved to estimate the savings that a mechanical heat-pump application would generate.

3.3.1 Mechanical Heat Pumps

To estimate savings for a mechanical heat pump, we need to know how much energy we will save, along with its value. We can determine the relationships between work input, temperature lift, and heat output using a parameter known as the heat pump Co-efficient of Performance (COP_{HP}).

$$COP_{HP} \text{ is defined as: } COP_{HP} = Q_{out} / W_{in}$$

where Q_{out} is the heat delivered by the heat pump and W_{in} is the energy or “work” supplied to the driver. For an ideal, Carnot-cycle heat pump, the COP is related to the heat delivery temperature and the temperature lift:

$$COP_{HP} = T_{out} / (T_{out} - T_{in})$$

Where T_{in} and T_{out} are the temperatures, in degrees Rankine, at which the heat pump receives and delivers heat respectively (for example, the evaporator and condenser). Note that these temperatures are not the process operating temperatures, but the heat-pump operating temperatures. Because a temperature difference between the process streams and the heat-pump working fluid must exist, the actual temperature lift internal to the heat pump is greater than the temperature lift applied to the process streams.

The COP_{HP} of an actual machine will be 65 to 75% of that for an ideal machine. For the purpose of estimating heat-pump work requirements, and operating cost, it is only necessary to know the expected operating temperatures. (Note that COP_{HP} is not the same as the more common term, ‘refrigeration COP (COP_{REF}),’ which is defined as $COP_{REF} = Q_{in} / Work_{in}$).

Figure 3.1 shows an example in which a process stream cooling from 170° F to 140° F is a 10 MMBtu/h heat source, and a process stream heating from 180° F to 210° F is the heat sink.

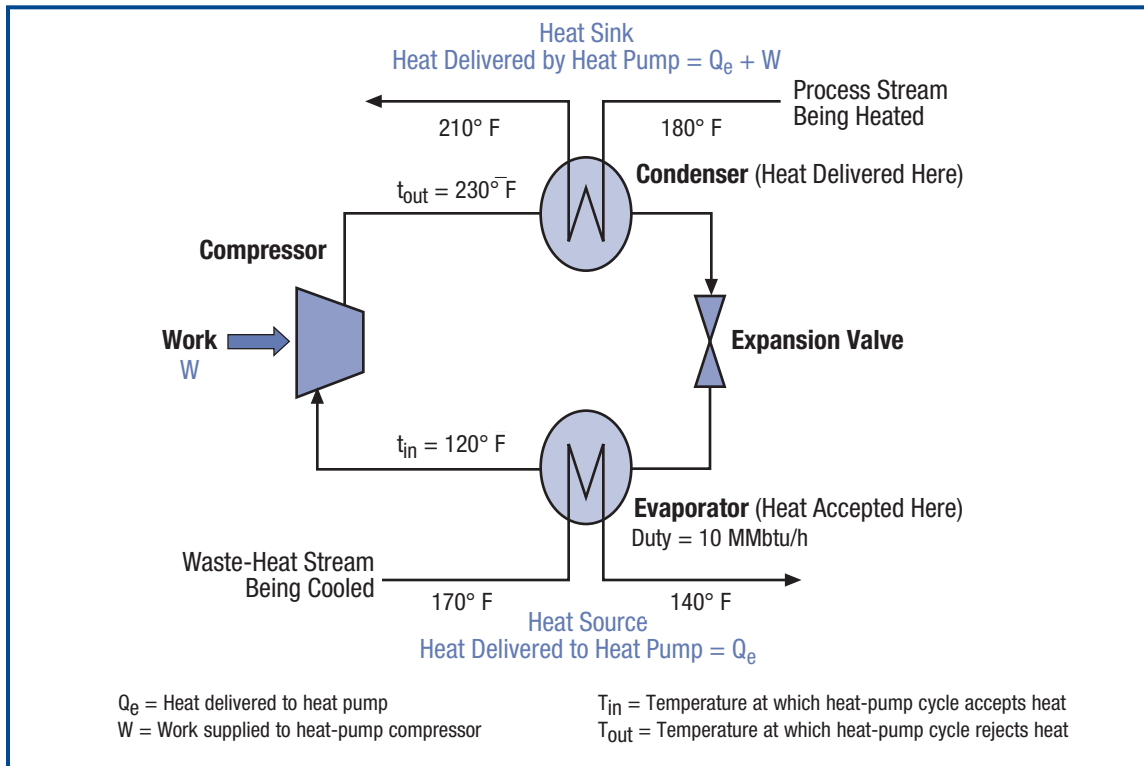

Figure 3.1: Mechanical Heat-Pump Operating Parameters Example

To calculate the work input, we need to determine the T_{in} and T_{out} for the heat pump.

T_{in} is determined by the temperature approach between the heat-pump working fluid and the lowest temperature of the heat source. In this case, the heat source is cooling to 140° F and there is a 20° F approach temperature in the evaporator, so $T_{in} = 120°$ F

T_{out} is determined by the temperature approach of the heat-pump working fluid to the hottest temperature that the heat sink achieves. In this case, the heat source is heating to 210° F and there is a 20° F approach temperature in the condenser, so $T_{out} = 230°$ F.

The ideal COP_{HP} for this example is:

$$(230+460) / (230-120) = 6.3$$

Assuming that the actual COP_{HP} is 70% of ideal, the estimated operating COP_{HP} will be:

$$6.3 \times 0.7 = 4.4$$

The energy balances for the heat pump are as follows:

$$\begin{aligned} COP_{HP} &= Q_{out} / W_{in} \\ Q_{out} &= Q_{in} + W \end{aligned}$$

Some mathematical rearranging gives the relationship between Q_{in} and W_{in} as:

$$W_{in} = Q_{in} / (COP - 1)$$

For the example, the work required to deliver the waste heat at the higher temperature is:

$$W_{in} = 10 \text{ MMBtu/h} / (4.4 - 1.0) = 2.9 \text{ MMBtu/h or } 862 \text{ kW}$$

And $Q_{out} = 10 \text{ MMBtu/h} + 2.9 \text{ MMBtu/h} = 12.9 \text{ MMBtu/h}$

Therefore, our heat pump is going to save 12.9 MMBtu/h of heat input to the process, at the cost of 862 kilowatts (kW) of electrical power.

If we assume that, in the base case, the cold process stream is heated with steam costing \$5.00/MMBtu, and that power costs 4.5 cents per kilowatt-hour (kWh), then we can calculate estimated savings as:

$$\text{Savings, } \$/\text{h} = (12.9 \times 5.00) - (862 \times 0.045) = 25.71 \text{ } \$/\text{h}$$

If the process runs 8,500 hours per year, the project could be justified based on obtaining \$218,500/yr in annual savings.

Note that if the driver were not an electric motor, the cost of shaft work for the particular device used would be substituted for power cost. In instances where turbines, or combustion engines are drivers, considering the overall site energy balance is necessary to correctly determine the cost of work.

The method described above helps determine if there are sufficient savings and incentive to pursue a heat-pump application. Although simplified, this method gives a reasonable idea of the energy-cost economics of installing a mechanical heat pump.

When evaluating economics, also consider non-energy cost benefits:

- **Product quality:** In lumber-drying applications, the gentler heating resulting from use of heat pumps results in better quality dried lumber and higher yields.
- **Offset capital costs:** In evaporation applications, using a heat pump means that boiler steam load and cooling water duty are avoided. This leads to reduced capital for boilers and/or cooling towers, together with lower NO_x emissions.

In addition, other costs may exist:

- Operating costs for auxiliary pumps and fans associated with the heat pumps
- Maintenance costs for the heat-pump equipment.

In conclusion, try to include all relevant costs and benefits in the detailed economic calculations.

3.3.2 Other Heat Pump Types

The COP_{HP} estimation method described above will work for most types of mechanically driven heat pumps.

For thermocompression heat pumps, the relationships between the heat recovered, thermal energy input, and temperature lift can be determined from specific charts provided by thermocompressor manufacturers.

3.4 What will the capital cost be?

Cost estimates are available for only a few common heat-pump applications:

- Lumber-drying kilns
- Mechanical-compression evaporators
- Thermocompression evaporators
- Steam jets for paper machines.

Most other industrial heat pump installations are custom designed, and must be costed by sizing the individual components (heat exchangers, compressors, etc.).

Consequently, there is a great deal of variation in costs. Historical costs for closed-cycle mechanical heat-pump systems range from \$50,000 to over \$200,000 per MMBtu of heat delivered; no predictable relationship exists between size of unit and cost.

As indicated earlier, simple paybacks for industrial heat-pump applications, where the primary goal is energy-cost reductions are typically 2 to 5 years.

3.5 What is the path from basic concept to installation for a heat-pump project?

As with any heat-recovery project, once a heat-pump opportunity is identified, the project needs to undergo a feasibility study and a detailed engineering design.

However, a few areas warrant special attention:

- **Sizing:** It is better to have a small, base-loaded installation with high operating hours than a unit that works at part load, part time.
- **Back-up:** A process operation must still be able to run should the heat pump break down. Address the need for a back-up.
- **Alternates:** A heat-pump installation will usually be more expensive than a passive-heat recovery project because heat has to be transferred twice (in and out of the heat pump), and a piece of rotating equipment may be needed.

A thorough heat-pump evaluation includes confirmation that a better alternative project has not been overlooked.

Use of heat-integration methods, such as Pinch Technology, are useful for this type of evaluation. Pinch Technology, in particular, provides a set of systematic analytical methods and tools that help identify both heat-recovery project opportunities and heat-pumping opportunities.

A STRONG ENERGY PORTFOLIO FOR A STRONG AMERICA

Energy efficiency and clean, renewable energy will mean a stronger economy, a cleaner environment, and greater energy independence for America. By investing in technology breakthroughs today, our nation can look forward to a more resilient economy and secure future.

Far-reaching technology changes will be essential to America's energy future. Working with a wide array of state, community, industry, and university partners, the U.S. Department of Energy's Office of Energy Efficiency and Renewable Energy invests in a diverse portfolio of energy technologies that will:

- Conserve energy in the residential, commercial, industrial, government, and transportation sectors
- Increase and diversify energy supply, with a focus on renewable domestic sources
- Upgrade our national energy infrastructure
- Facilitate the emergence of hydrogen technologies as a vital new "energy carrier."

The Opportunities

Biomass Program

Using domestic, plant-derived resources to meet our fuel, power, and chemical needs

Building Technologies Program

Homes, schools, and businesses that use less energy, cost less to operate, and ultimately, generate as much power as they use

Distributed Energy & Electric Reliability Program

A more reliable energy infrastructure and reduced need for new power plants

Federal Energy Management Program

Leading by example, saving energy and taxpayer dollars in federal facilities

FreedomCAR & Vehicle Technologies Program

Less dependence on foreign oil, and eventual transition to an emissions-free, petroleum-free vehicle

Geothermal Technologies Program

Tapping the earth's energy to meet our heat and power needs

Hydrogen, Fuel Cells & Infrastructure Technologies Program

Paving the way toward a hydrogen economy and net-zero carbon energy future

Industrial Technologies Program

Boosting the productivity and competitiveness of U.S. industry through improvements in energy and environmental performance

Solar Energy Technology Program

Utilizing the sun's natural energy to generate electricity and provide water and space heating

Weatherization & Intergovernmental Program

Accelerating the use of today's best energy-efficient and renewable technologies in homes, communities, and businesses

Wind & Hydropower Technologies Program

Harnessing America's abundant natural resources for clean power generation

To learn more, visit www.eere.energy.gov

ACKNOWLEDGEMENTS:

The Industrial Technologies Program would like to thank Andrew McMullan, Veritech Inc., for writing this BestPractices Steam Technical Brief, and the BestPractices Steam technical subcommittee for reviewing the publication.



FOR ADDITIONAL INFORMATION, PLEASE CONTACT:

DOE Information Clearinghouse
Phone: (800) 862-2086
Fax: (360) 586-8303
clearinghouse@ee.doe.gov

Visit our home page at
www.oit.doe.gov

Please send any comments,
questions, or suggestions to
webmaster.oit@ee.doe.gov

Industrial Technologies Program
Energy Efficiency
and Renewable Energy
U.S. Department of Energy
Washington, DC 20585-0121

DOE/GO-102003-1735
June 2003