



*An Online PDH Course
brought to you by
CEDengineering.com*

Roundabout Geometric Design

Course No: C04-004

Credit: 4 PDH

Gilbert Gedeon, P.E.



Continuing Education and Development, Inc.

P: (877) 322-5800

info@cedengineering.com

This course was adapted from the Department of Transportation, Publication No. DOT-FHWA-RD-00-067, “Understanding Roundabouts”, which is in the public domain.



Geometric Design

6.1	Introduction	130
6.1.1	Geometric elements	130
6.1.2	Design process	130
6.2	General Design Principles	132
6.2.1	Speeds through the roundabout	132
6.2.2	Design vehicle	142
6.2.3	Nonmotorized design users	144
6.2.4	Alignment of approaches and entries	144
6.3	Geometric Elements	145
6.3.1	Inscribed circle diameter	145
6.3.2	Entry width	147
6.3.3	Circulatory roadway width	149
6.3.4	Central island	150
6.3.5	Entry curves	152
6.3.6	Exit curves	154
6.3.7	Pedestrian crossing location and treatments	155
6.3.8	Splitter islands	157
6.3.9	Stopping sight distance	159
6.3.10	Intersection sight distance	161
6.3.11	Vertical considerations	164
6.3.12	Bicycle provisions	167

6.3.13	Sidewalk treatments	168
6.3.14	Parking considerations and bus stop locations	169
6.3.15	Right-turn bypass lanes	170
6.4	Double-Lane Roundabouts	172
6.4.1	The natural vehicle path	172
6.4.2	Vehicle path overlap	174
6.4.3	Design method to avoid path overlap	174
6.5	Rural Roundabouts	176
6.5.1	Visibility	177
6.5.2	Curbing	177
6.5.3	Splitter islands	177
6.5.4	Approach curves	178
6.6	Mini-Roundabouts	179
6.7	References	181
Exhibit 6-1.	Basic geometric elements of a roundabout.	131
Exhibit 6-2.	Roundabout design process.	131
Exhibit 6-3.	Sample theoretical speed profile (urban compact roundabout).	133
Exhibit 6-4.	Recommended maximum entry design speeds.	133
Exhibit 6-5.	Fastest vehicle path through single-lane roundabout.	134
Exhibit 6-6.	Fastest vehicle path through double-lane roundabout.	135
Exhibit 6-7.	Example of critical right-turn movement.	135
Exhibit 6-8.	Side friction factors at various speeds (metric units).	137
Exhibit 6-9.	Side friction factors at various speeds (U.S. customary units).	137
Exhibit 6-10.	Speed-radius relationship (metric units).	138
Exhibit 6-11.	Speed-radius relationship (U.S. customary units).	138
Exhibit 6-12.	Vehicle path radii.	139
Exhibit 6-13.	Approximated R_4 values and corresponding R_1 values (metric units).	141
Exhibit 6-14.	Approximated R_4 values and corresponding R_1 values (U.S. customary units).	141
Exhibit 6-15.	Through-movement swept path of WB-15 (WB-50) vehicle.	143
Exhibit 6-16.	Left-turn and right-turn swept paths of WB-15 (WB-50) vehicle.	143
Exhibit 6-17.	Key dimensions of nonmotorized design users.	144
Exhibit 6-18.	Radial alignment of entries.	145
Exhibit 6-19.	Recommended inscribed circle diameter ranges.	146
Exhibit 6-20.	Approach widening by adding full lane.	148

Exhibit 6-21.	Approach widening by entry flaring.	148
Exhibit 6-22.	Minimum circulatory lane widths for two-lane roundabouts.	150
Exhibit 6-23.	Example of central island with a traversable apron.	151
Exhibit 6-24.	Single-lane roundabout entry design.	153
Exhibit 6-25.	Single-lane roundabout exit design.	154
Exhibit 6-26.	Minimum splitter island dimensions.	157
Exhibit 6-27.	Minimum splitter island nose radii and offsets.	158
Exhibit 6-28.	Design values for stopping sight distances.	159
Exhibit 6-29.	Approach sight distance.	160
Exhibit 6-30.	Sight distance on circulatory roadway.	160
Exhibit 6-31.	Sight distance to crosswalk on exit.	161
Exhibit 6-32.	Intersection sight distance.	162
Exhibit 6-33.	Computed length of conflicting leg of intersection sight triangle.	163
Exhibit 6-34.	Sample plan view.	164
Exhibit 6-35.	Sample approach profile.	165
Exhibit 6-36.	Sample central island profile.	165
Exhibit 6-37.	Typical circulatory roadway section.	166
Exhibit 6-38.	Typical section with a truck apron.	166
Exhibit 6-39.	Possible provisions for bicycles.	168
Exhibit 6-40.	Sidewalk treatments.	169
Exhibit 6-41.	Example of right-turn bypass lane.	170
Exhibit 6-42.	Configuration of right-turn bypass lane with acceleration lane.	171
Exhibit 6-43.	Configuration of right-turn bypass lane with yield at exit leg.	172
Exhibit 6-44.	Sketched natural paths through a double-lane roundabout.	173
Exhibit 6-45.	Path overlap at a double-lane roundabout.	174
Exhibit 6-46.	One method of entry design to avoid path overlap at double-lane roundabouts.	175
Exhibit 6-47.	Alternate method of entry design to avoid path overlap at double-lane roundabouts.	175
Exhibit 6-48.	Extended splitter island treatment.	178
Exhibit 6-49.	Use of successive curves on high speed approaches.	179
Exhibit 6-50.	Example of mini-roundabout.	180

Chapter 6 Geometric Design

Roundabout design involves trade-offs among safety, operations, and accommodating large vehicles.

Some roundabout features are uniform, while others vary depending on the location and size of the roundabout.

Roundabout design is an iterative process.

6.1 Introduction

Designing the geometry of a roundabout involves choosing between trade-offs of safety and capacity. Roundabouts operate most safely when their geometry forces traffic to enter and circulate at slow speeds. Horizontal curvature and narrow pavement widths are used to produce this reduced-speed environment. Conversely, the capacity of roundabouts is negatively affected by these low-speed design elements. As the widths and radii of entry and circulatory roadways are reduced, so also the capacity of the roundabout is reduced. Furthermore, many of the geometric parameters are governed by the maneuvering requirements of the largest vehicles expected to travel through the intersection. Thus, designing a roundabout is a process of determining the optimal balance between safety provisions, operational performance, and large vehicle accommodation.

While the basic form and features of roundabouts are uniform regardless of their location, many of the design techniques and parameters are different, depending on the speed environment and desired capacity at individual sites. In rural environments where approach speeds are high and bicycle and pedestrian use may be minimal, the design objectives are significantly different from roundabouts in urban environments where bicycle and pedestrian safety are a primary concern. Additionally, many of the design techniques are substantially different for single-lane roundabouts than for roundabouts with multiple entry lanes.

This chapter is organized so that the fundamental design principles common among all roundabout types are presented first. More detailed design considerations specific to multilane roundabouts, rural roundabouts, and mini-roundabouts are given in subsequent sections of the chapter.

6.1.1 Geometric elements

Exhibit 6-1 provides a review of the basic geometric features and dimensions of a roundabout. Chapter 1 provided the definitions of these elements.

6.1.2 Design process

The process of designing roundabouts, more so than other forms of intersections, requires a considerable amount of iteration among geometric layout, operational analysis, and safety evaluation. As described in Chapters 4 and 5, minor adjustments in geometry can result in significant changes in the safety and/or operational performance. Thus, the designer often needs to revise and refine the initial layout attempt to enhance its capacity and safety. It is rare to produce an optimal geometric design on the first attempt. Exhibit 6-2 provides a graphical flowchart for the process of designing and evaluating a roundabout.

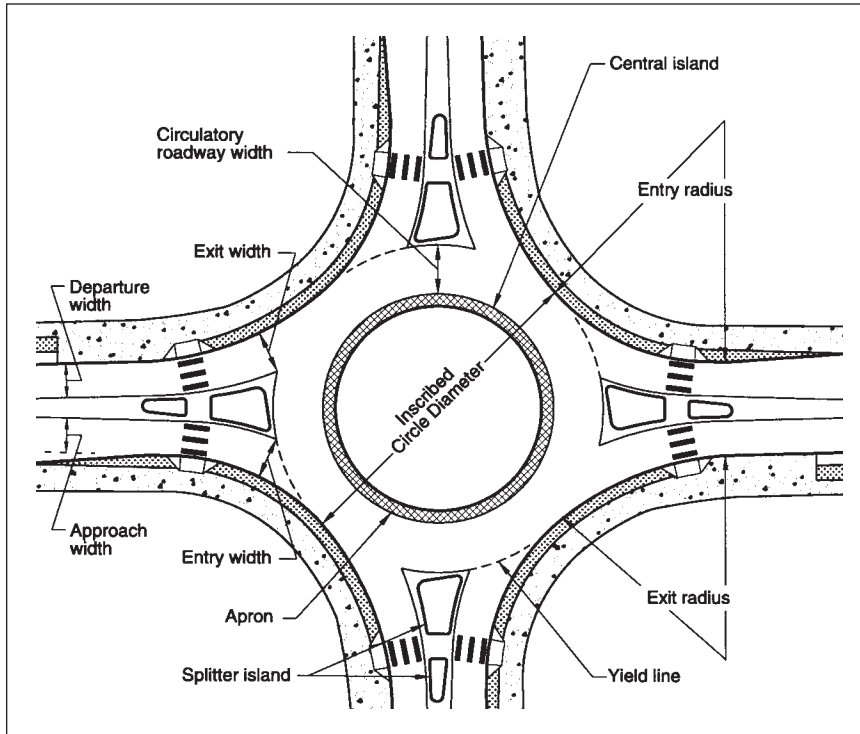

Exhibit 6-1. Basic geometric elements of a roundabout.

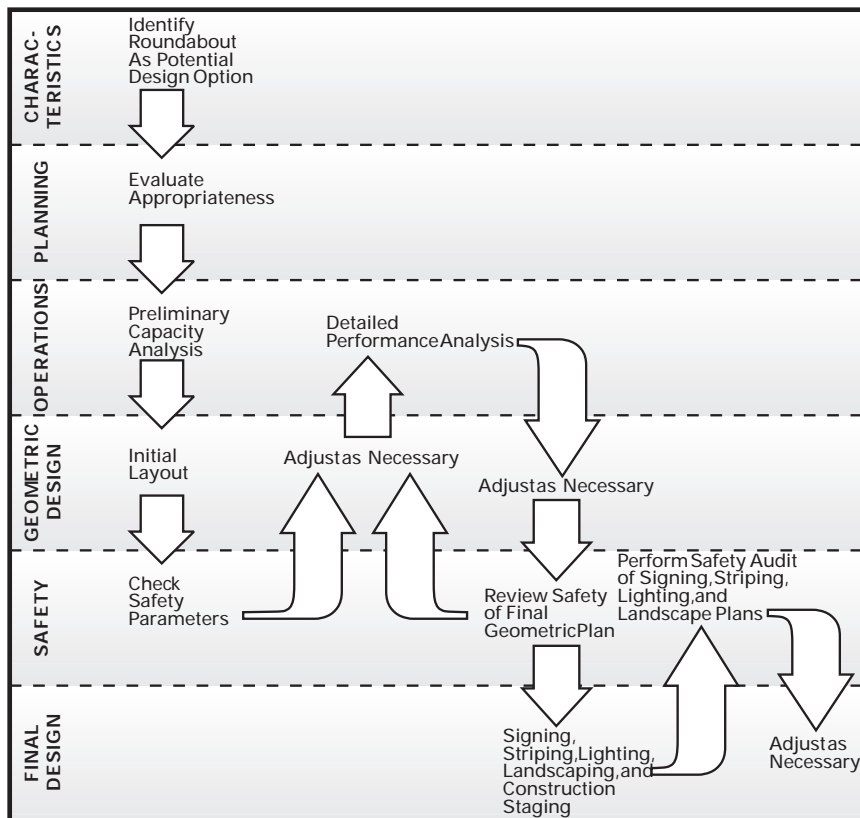

Exhibit 6-2. Roundabout design process.

Because roundabout design is such an iterative process, in which small changes in geometry can result in substantial changes to operational and safety performance, it may be advisable to prepare the initial layout drawings at a sketch level of detail. Although it is easy to get caught into the desire to design each of the individual components of the geometry such that it complies with the specifications provided in this chapter, it is much more important that the individual components are compatible with each other so that the roundabout will meet its overall performance objectives. Before the details of the geometry are defined, three fundamental elements must be determined in the preliminary design stage:

1. The optimal roundabout size;
2. The optimal position; and
3. The optimal alignment and arrangement of approach legs.

6.2 General Design Principles

This section describes the fundamental design principles common among all categories of roundabouts. Guidelines for the design of each geometric element are provided in the following section. Further guidelines specific to double-lane roundabouts, rural roundabouts, and mini-roundabouts are given in subsequent sections. Note that double-lane roundabout design is significantly different from single-lane roundabout design, and many of the techniques used in single-lane roundabout design do not directly transfer to double-lane design.

6.2.1 Speeds through the roundabout

The most critical design objective is achieving appropriate vehicular speeds through the roundabout.

Because it has profound impacts on safety, achieving appropriate vehicular speeds through the roundabout is the most critical design objective. A well-designed roundabout reduces the relative speeds between conflicting traffic streams by requiring vehicles to negotiate the roundabout along a curved path.

6.2.1.1 Speed profiles

Exhibit 6-3 shows the operating speeds of typical vehicles approaching and negotiating a roundabout. Approach speeds of 40, 55, and 70 km/h (25, 35, and 45 mph, respectively) about 100 m (325 ft) from the center of the roundabout are shown. Deceleration begins before this time, with circulating drivers operating at approximately the same speed on the roundabout. The relatively uniform negotiation speed of all drivers on the roundabout means that drivers are able to more easily choose their desired paths in a safe and efficient manner.

6.2.1.2 Design speed

Increasing vehicle path curvature decreases relative speeds between entering and circulating vehicles, but also increases side friction between adjacent traffic streams in multilane roundabouts.

International studies have shown that increasing the vehicle path curvature decreases the relative speed between entering and circulating vehicles and thus usually results in decreases in the entering-circulating and exiting-circulating vehicle crash rates. However, at multilane roundabouts, increasing vehicle path curvature creates greater side friction between adjacent traffic streams and can result in more vehicles cutting across lanes and higher potential for sideswipe crashes (2). Thus, for each roundabout, there exists an optimum design speed to minimize crashes.

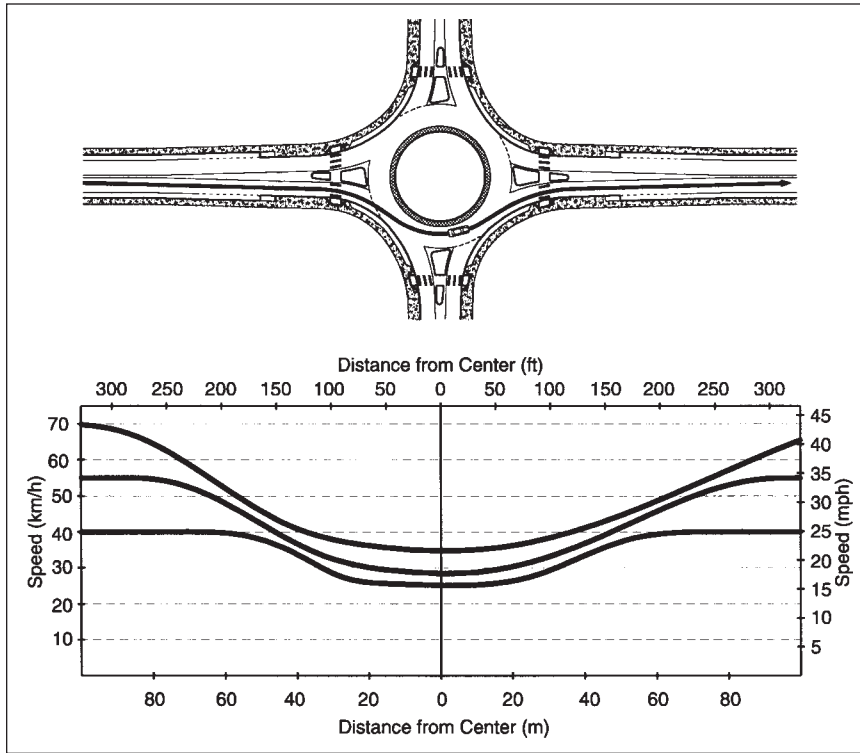

Exhibit 6-3. Sample theoretical speed profile (urban compact roundabout).

Recommended maximum entry design speeds for roundabouts at various intersection site categories are provided in Exhibit 6-4.

Site Category	Recommended Maximum Entry Design Speed
Mini-Roundabout	25 km/h (15 mph)
Urban Compact	25 km/h (15 mph)
Urban Single Lane	35 km/h (20 mph)
Urban Double Lane	40 km/h (25 mph)
Rural Single Lane	40 km/h (25 mph)
Rural Double Lane	50 km/h (30 mph)

Exhibit 6-4. Recommended maximum entry design speeds.

Roundabout speed is determined by the fastest path allowed by the geometry.

6.2.1.3 Vehicle paths

To determine the speed of a roundabout, the fastest path allowed by the geometry is drawn. This is the smoothest, flattest path possible for a single vehicle, in the absence of other traffic and ignoring all lane markings, traversing through the entry, around the central island, and out the exit. Usually the fastest possible path is the through movement, but in some cases it may be a right turn movement.

A vehicle is assumed to be 2 m (6 ft) wide and to maintain a minimum clearance of 0.5 m (2 ft) from a roadway centerline or concrete curb and flush with a painted edge line (2). Thus the centerline of the vehicle path is drawn with the following distances to the particular geometric features:

- 1.5 m (5 ft) from a concrete curb,
- 1.5 m (5 ft) from a roadway centerline, and
- 1.0 m (3 ft) from a painted edge line.

Through movements are usually the fastest path, but sometimes right turn paths are more critical.

Exhibits 6-5 and 6-6 illustrate the construction of the fastest vehicle paths at a single-lane roundabout and at a double-lane roundabout, respectively. Exhibit 6-7 provides an example of an approach at which the right-turn path is more critical than the through movement.

Exhibit 6-5. Fastest vehicle path through single-lane roundabout.

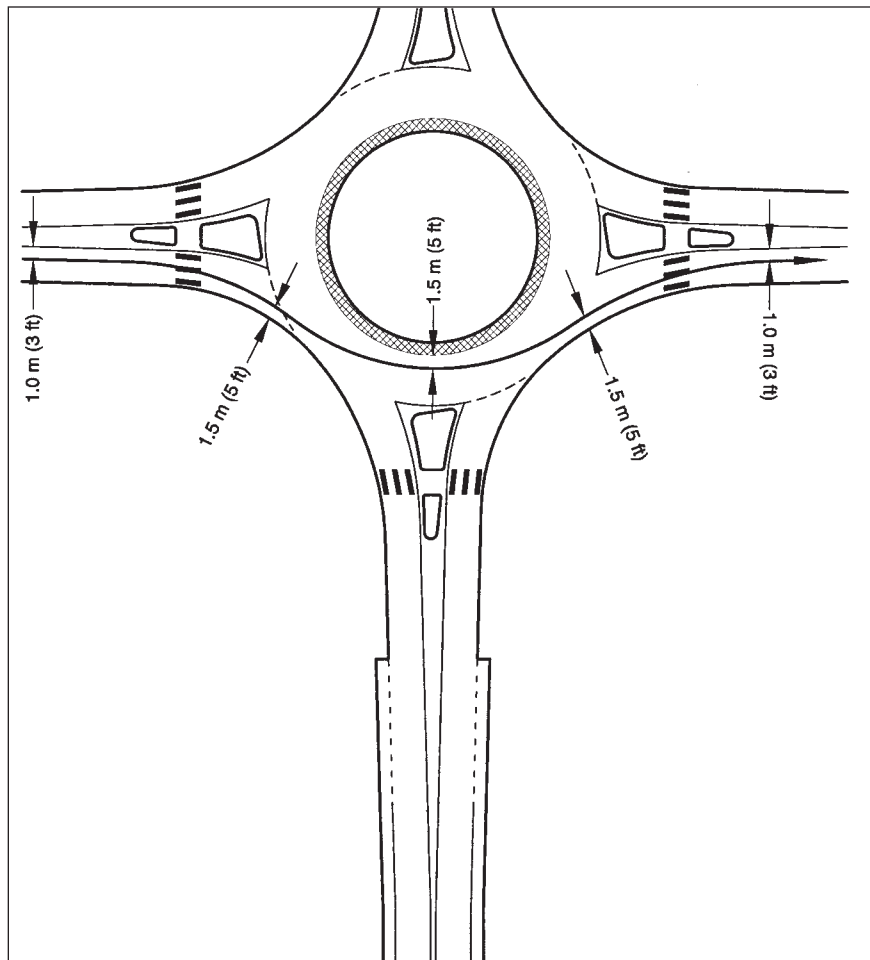

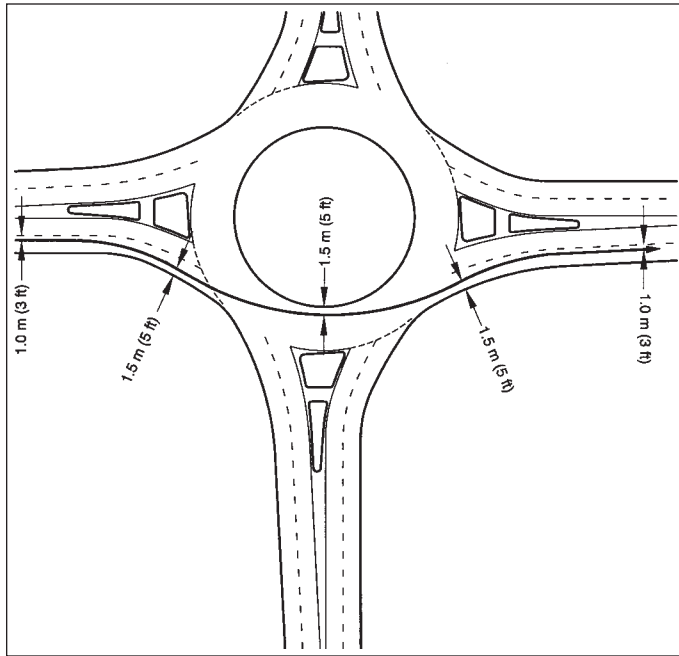

Exhibit 6-6. Fastest vehicle path through double-lane roundabout.

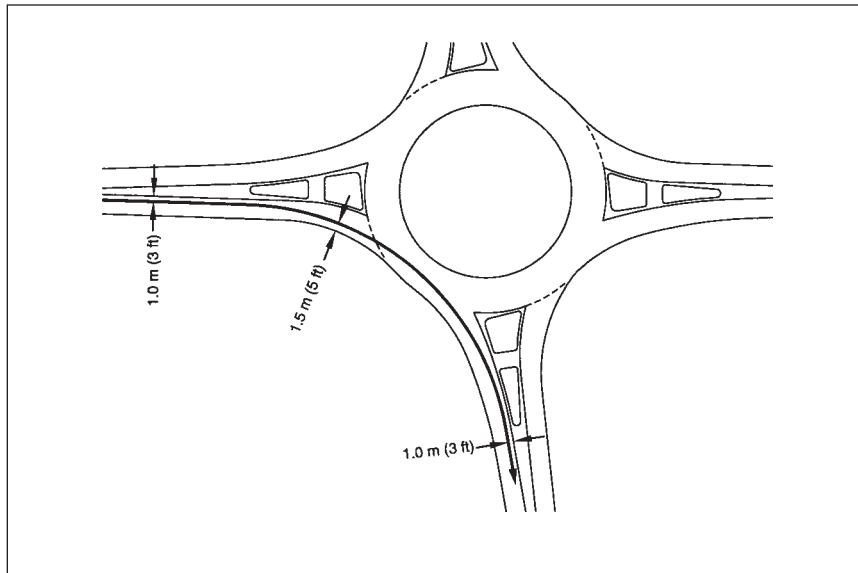

Exhibit 6-7. Example of critical right-turn movement.

As shown in Exhibits 6-5 and 6-6, the fastest path for the through movement is a series of reverse curves (i.e., a curve to the right, followed by a curve to the left, followed by a curve to the right). When drawing the path, a short length of tangent should be drawn between consecutive curves to account for the time it takes for a driver to turn the steering wheel. It may be initially better to draw the path freehand, rather than using drafting templates or a computer-aided design (CAD) program. The freehand technique may provide a more natural representation of the way a driver negotiates the roundabout, with smooth transitions connecting curves and tangents. Having sketched the fastest path, the designer can then measure the minimum radii using suitable curve templates or by replicating the path in CAD and using it to determine the radii.

The entry path radius should not be significantly larger than the circulatory radius.

The design speed of the roundabout is determined from the smallest radius along the fastest allowable path. The smallest radius usually occurs on the circulatory roadway as the vehicle curves to the left around the central island. However, it is important when designing the roundabout geometry that the radius of the entry path (i.e., as the vehicle curves to the right through entry geometry) not be significantly larger than the circulatory path radius.

Draw the fastest path for all roundabout approaches.

The fastest path should be drawn for all approaches of the roundabout. Because the construction of the fastest path is a subjective process requiring a certain amount of personal judgment, it may be advisable to obtain a second opinion.

6.2.1.4 Speed-curve relationship

The relationship between travel speed and horizontal curvature is documented in the American Association of State Highway and Transportation Officials' document, A Policy on Geometric Design of Highways and Streets, commonly known as the Green Book (4). Equation 6-1 can be used to calculate the design speed for a given travel path radius.

$$V = \sqrt{127R(e+f)} \quad (6-1a, \text{ metric})$$

$$V = \sqrt{15R(e+f)} \quad (6-1b, \text{ U.S. customary})$$

where: V = Design speed, km/h
 R = Radius, m
 e = superelevation, m/m
 f = side friction factor

where: V = Design speed, mph
 R = Radius, ft
 e = superelevation, ft/ft
 f = side friction factor

Superelevation values are usually assumed to be +0.02 for entry and exit curves and -0.02 for curves around the central island. For more details related to superelevation design, see Section 6.3.11.

Values for side friction factor can be determined in accordance with the AASHTO relation for curves at intersections (see 1994 AASHTO Figure III-19 (4)). The coefficient of friction between a vehicle's tires and the pavement varies with the vehicle's speed, as shown in Exhibits 6-8 and 6-9 for metric and U.S. customary units, respectively.

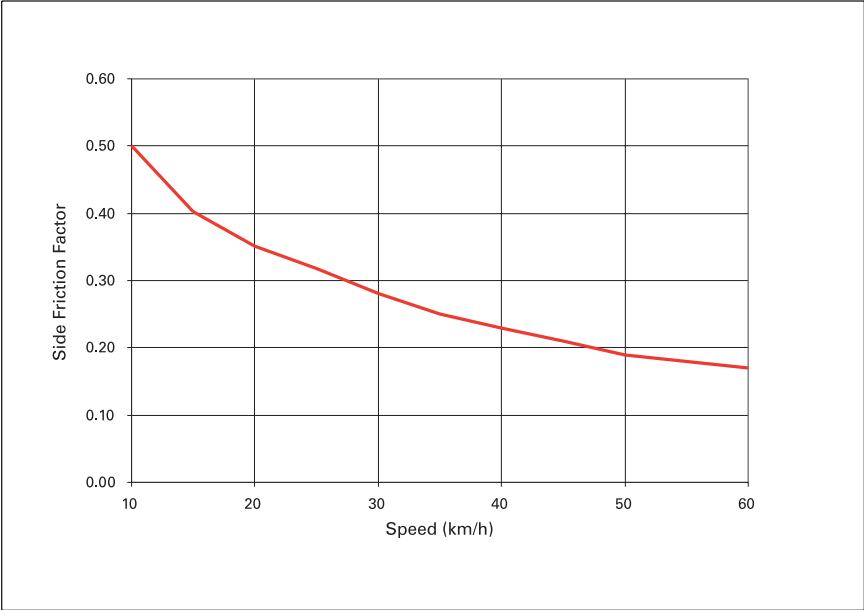

Exhibit 6-8. Side friction factors at various speeds (metric units).

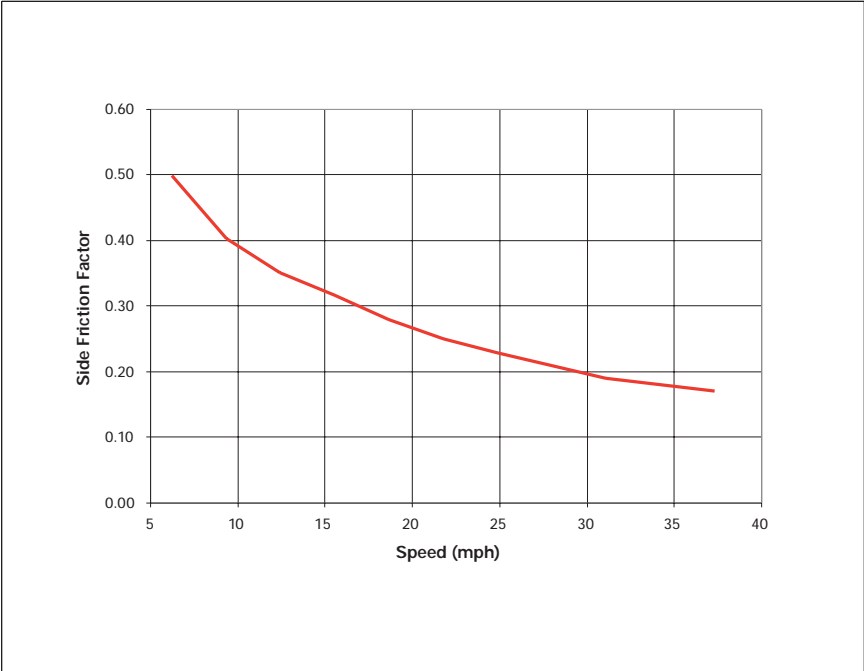

Exhibit 6-9. Side friction factors at various speeds (U.S. customary units).

Using the appropriate friction factors corresponding to each speed, Exhibits 6-10 and 6-11 present charts in metric and U.S. customary units, respectively, showing the speed-radius relationship for curves for both a +0.02 superelevation and -0.02 superelevation.

Exhibit 6-10. Speed-radius relationship (metric units).

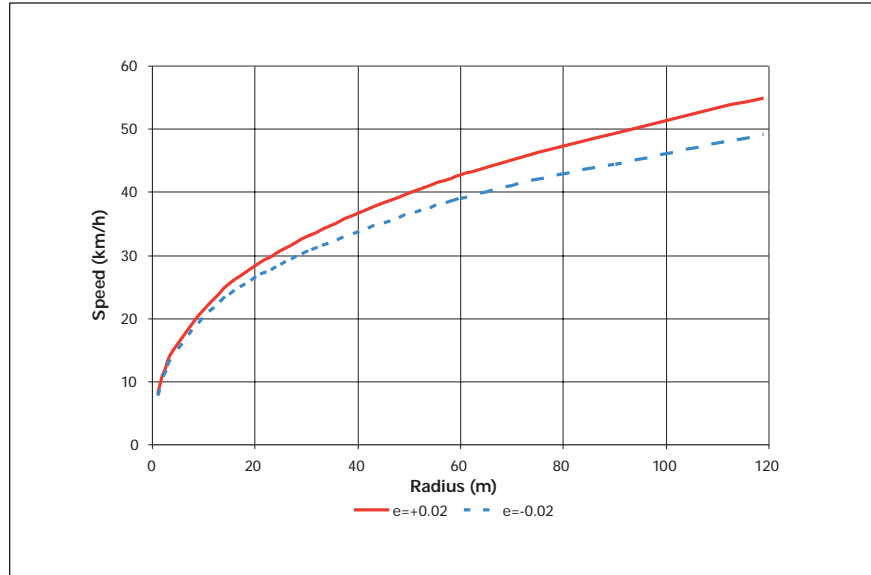
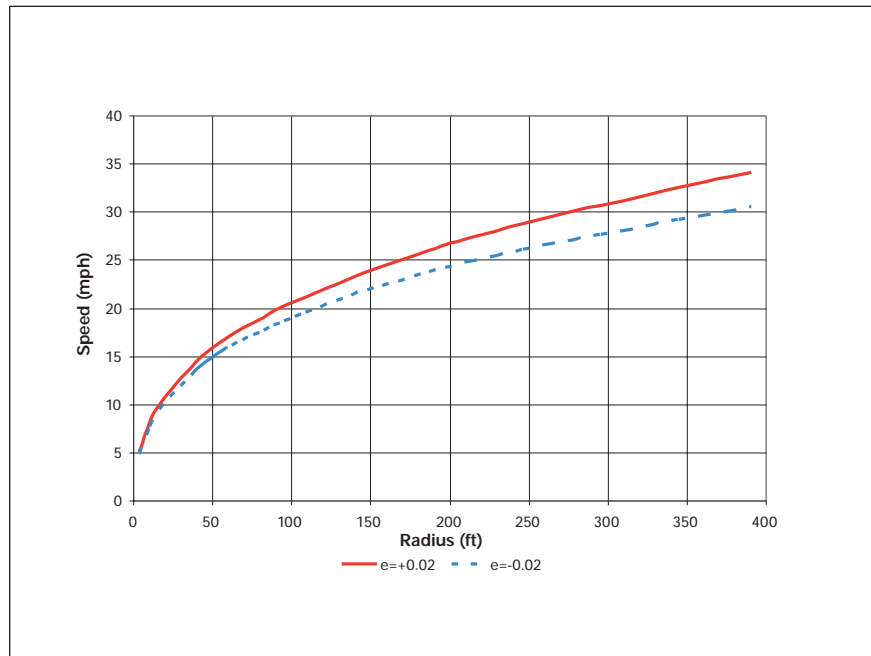

Exhibit 6-11. Speed-radius relationship (U.S. customary units.)



6.2.1.5 Speed consistency

In addition to achieving an appropriate design speed for the fastest movements, another important objective is to achieve consistent speeds for all movements. Along with overall reductions in speed, speed consistency can help to minimize the crash rate and severity between conflicting streams of vehicles. It also simplifies the task of merging into the conflicting traffic stream, minimizing critical gaps, thus optimizing entry capacity. This principle has two implications:

1. The relative speeds between consecutive geometric elements should be minimized; and
2. The relative speeds between conflicting traffic streams should be minimized.

As shown in Exhibit 6-12, five critical path radii must be checked for each approach. R_1 , the *entry path radius*, is the minimum radius on the fastest through path prior to the yield line. R_2 , the *circulating path radius*, is the minimum radius on the fastest through path around the central island. R_3 , the *exit path radius*, is the minimum radius on the fastest through path into the exit. R_4 , the *left-turn path radius*, is the minimum radius on the path of the conflicting left-turn movement. R_5 , the *right-turn path radius*, is the minimum radius on the fastest path of a right-turning vehicle. It is important to note that these vehicular path radii are not the same as the curb radii. First the basic curb geometry is laid out, and then the vehicle paths are drawn in accordance with the procedures described in Section 6.2.1.3.

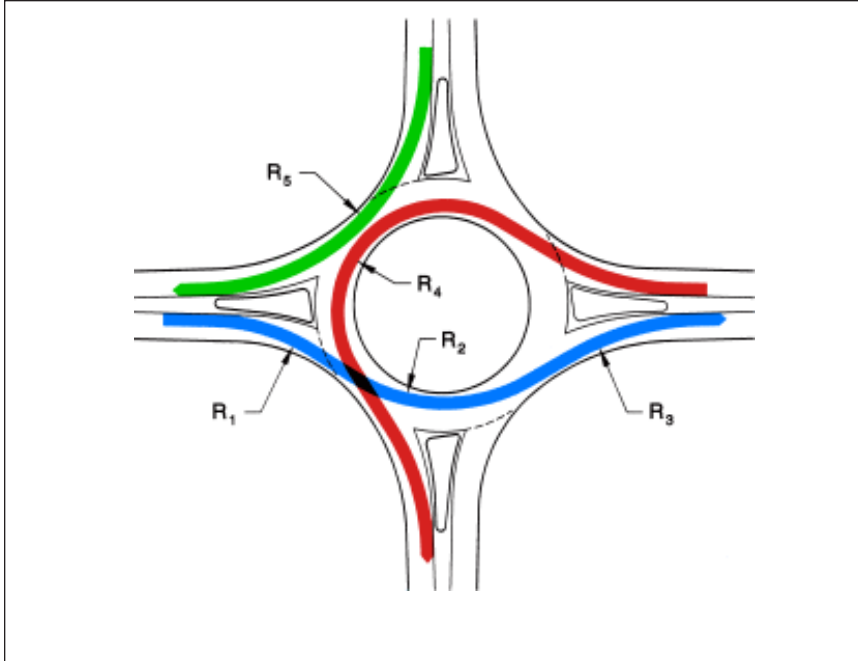

Exhibit 6-12. Vehicle path radii.

On the fastest path, it is desirable for R_1 to be smaller than R_2 , which in turn should be smaller than R_3 . This ensures that speeds will be reduced to their lowest level at the roundabout entry and will thereby reduce the likelihood of loss-of-control crashes. It also helps to reduce the speed differential between entering and circulating traffic, thereby reducing the entering-circulating vehicle crash rate. However, in some cases it may not be possible to achieve an R_1 value less than R_2 within given right-of-way or topographic constraints. In such cases, it is acceptable for R_1 to be greater than R_2 , provided the relative difference in speeds is less than 20 km/h (12 mph) and preferably less than 10 km/h (6 mph).

The *natural path* of a vehicle is the path that a driver would take in the absence of other conflicting vehicles.

At single-lane roundabouts, it is relatively simple to reduce the value of R_1 . The curb radius at the entry can be reduced or the alignment of the approach can be shifted further to the left to achieve a slower entry speed (with the potential for higher exit speeds that may put pedestrians at risk). However, at double-lane roundabouts, it is generally more difficult as overly small entry curves can cause the *natural path* of adjacent traffic streams to overlap. Path overlap happens when the geometry leads a vehicle in the left approach lane to naturally sweep across the right approach lane just before the approach line to avoid the central island. It may also happen within the circulatory roadway when a vehicle entering from the right-hand lane naturally cuts across the left side of the circulatory roadway close to the central island. When path overlap occurs at double-lane roundabouts, it may reduce capacity and increase crash risk. Therefore, care must be taken when designing double-lane roundabouts to achieve ideal values for R_1 , R_2 , and R_3 . Section 6.4 provides further guidance on eliminating path overlap at double-lane roundabouts.

The exit radius, R_3 , should not be less than R_1 or R_2 in order to minimize loss-of-control crashes. At single-lane roundabouts with pedestrian activity, exit radii may still be small (the same or slightly larger than R_2) in order to minimize exit speeds. However, at double-lane roundabouts, additional care must be taken to minimize the likelihood of exiting path overlap. Exit path overlap can occur at the exit when a vehicle on the left side of the circulatory roadway (next to the central island) exits into the right-hand exit lane. Where no pedestrians are expected, the exit radii should be just large enough to minimize the likelihood of exiting path overlap. Where pedestrians are present, tighter exit curvature may be necessary to ensure sufficiently low speeds at the downstream pedestrian crossing.

The radius of the conflicting left-turn movement, R_4 , must be evaluated in order to ensure that the maximum speed differential between entering and circulating traffic is no more than 20 km/h (12 mph). The left-turn movement is the critical traffic stream because it has the lowest circulating speed. Large differentials between entry and circulating speeds may result in an increase in single-vehicle crashes due to loss of control. Generally, R_4 can be determined by adding 1.5 m (5 ft) to the central island radius. Based on this assumption, Exhibits 6-13 and 6-14 show approximate R_4 values and corresponding maximum R_1 values for various inscribed circle diameters in metric and U.S. customary units, respectively.

Finally, the radius of the fastest possible right-turn path, R_5 , is evaluated. Like R_1 , the right-turn radius should have a design speed at or below the maximum design speed of the roundabout and no more than 20 km/h (12 mph) above the conflicting R_4 design speed.

Inscribed Circle Diameter (m)	Approximate R_4 Value		Maximum R_1 Value	
	Radius (m)	Speed (km/h)	Radius (m)	Speed (km/h)
Single-Lane Roundabout				
30	11	21	54	41
35	13	23	61	43
40	16	25	69	45
45	19	26	73	46
Double-Lane Roundabout				
45	15	24	65	44
50	17	25	69	45
55	20	27	78	47
60	23	28	83	48
65	25	29	88	49
70	28	30	93	50

Exhibit 6-13. Approximated R_4 values and corresponding R_1 values (metric units).

Inscribed Circle Diameter (m)	Approximate R_4 Value		Maximum R_1 Value	
	Radius (ft)	Speed (mph)	Radius (ft)	Speed (mph)
Single-Lane Roundabout				
100	35	13	165	25
115	45	14	185	26
130	55	15	205	27
150	65	15	225	28
Double-Lane Roundabout				
150	50	15	205	27
165	60	16	225	28
180	65	16	225	28
200	75	17	250	29
215	85	18	275	30
230	90	18	275	30

Exhibit 6-14. Approximated R_4 values and corresponding R_1 values (U.S. customary units).

The design vehicle dictates many of the roundabout's dimensions.

6.2.2 Design vehicle

Another important factor determining a roundabout's layout is the need to accommodate the largest motorized vehicle likely to use the intersection. The turning path requirements of this vehicle, termed hereafter the *design vehicle*, will dictate many of the roundabout's dimensions. Before beginning the design process, the designer must be conscious of the design vehicle and possess the appropriate vehicle turning templates or a CAD-based vehicle turning path program to determine the vehicle's swept path.

The choice of design vehicle will vary depending upon the approaching roadway types and the surrounding land use characteristics. The local or State agency with jurisdiction of the associated roadways should usually be consulted to identify the design vehicle at each site. The AASHTO *A Policy on Geometric Design of Highways and Streets* provides the dimensions and turning path requirements for a variety of common highway vehicles (4). Commonly, WB-15 (WB-50) vehicles are the largest vehicles along collectors and arterials. Larger trucks, such as WB-20 (WB-67) vehicles, may need to be addressed at intersections on interstate freeways or State highway systems. Smaller design vehicles may often be chosen for local street intersections.

In general, larger roundabouts need to be used to accommodate large vehicles while maintaining low speeds for passenger vehicles. However, in some cases, land constraints may limit the ability to accommodate large semi-trailer combinations while achieving adequate deflection for small vehicles. At such times, a truck apron may be used to provide additional traversable area around the central island for large semi-trailers. Truck aprons, though, provide a lower level of operation than standard nonmountable islands and should be used only when there is no other means of providing adequate deflection while accommodating the design vehicle.

Exhibits 6-15 and 6-16 demonstrate the use of a CAD-based computer program to determine the vehicle's swept path through the critical turning movements.

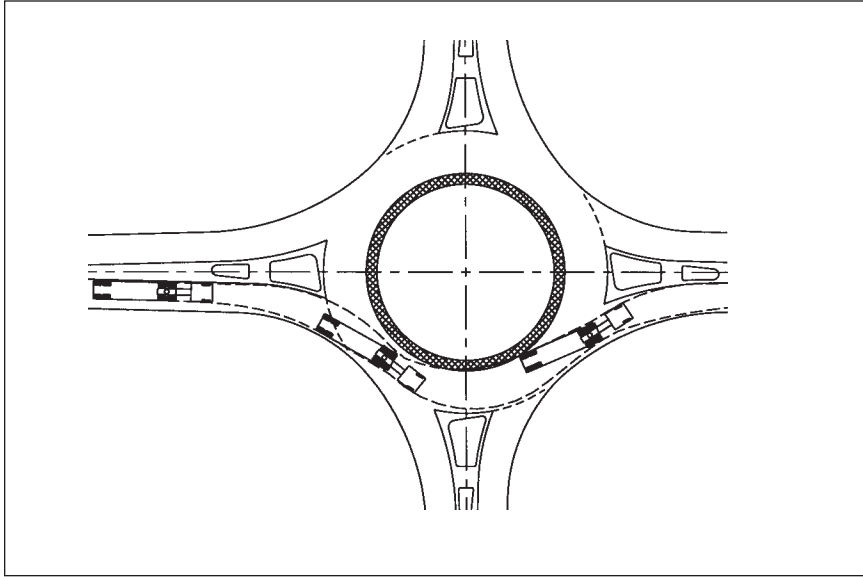

Exhibit 6-15. Through-movement swept path of WB-15 (WB-50) vehicle.

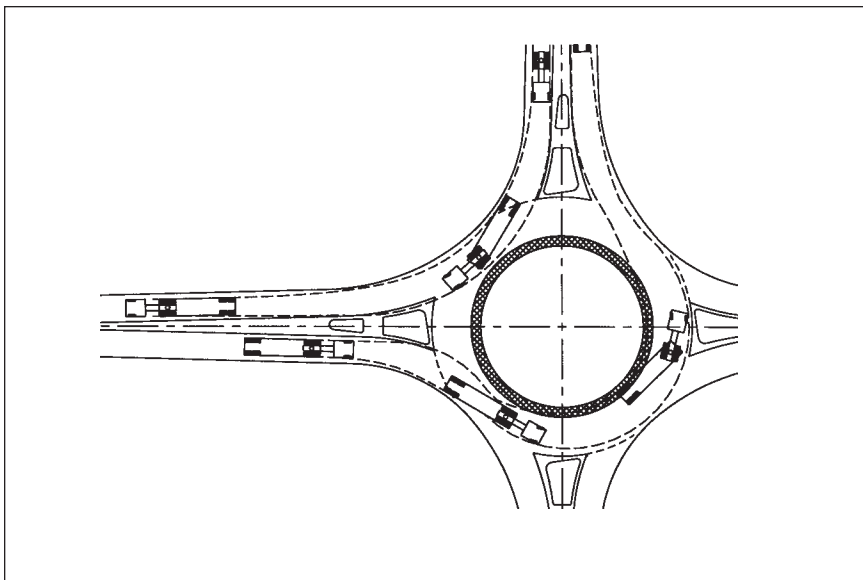

Exhibit 6-16. Left-turn and right-turn swept paths of WB-15 (WB-50) vehicle.

6.2.3 Nonmotorized design users

Like the motorized design vehicle, the design criteria of nonmotorized potential roundabout users (bicyclists, pedestrians, skaters, wheelchair users, strollers, etc.) should be considered when developing many of the geometric elements of a roundabout design. These users span a wide range of ages and abilities that can have a significant effect on the design of a facility.

The basic design dimensions for various design users are given in Exhibit 6-17 (5).

Exhibit 6-17. Key dimensions of nonmotorized design users.

User	Dimension	Affected Roundabout Features
Bicycles		
Length	1.8 m (5.9 ft)	Splitter island width at crosswalk
Minimum operating width	1.5 m (4.9 ft)	Bike lane width
Lateral clearance on each side	0.6 m (2.0 ft); 1.0 m (3.3 ft) to obstructions	Shared bicycle-pedestrian path width
Pedestrian (walking)		
Width	0.5 m (1.6 ft)	Sidewalk width, crosswalk width
Wheelchair		
Minimum width	0.75 m (2.5 ft)	Sidewalk width, crosswalk width
Operating width	0.90 m (3.0 ft)	Sidewalk width, crosswalk width
Person pushing stroller		
Length	1.70 m (5.6 ft)	Splitter island width at crosswalk
Skaters		
Typical operating width	1.8 m (6 ft)	Sidewalk width

Source: (5)

6.2.4 Alignment of approaches and entries

In general, the roundabout is optimally located when the centerlines of all approach legs pass through the center of the inscribed circle. This location usually allows the geometry to be adequately designed so that vehicles will maintain slow speeds through both the entries and the exits. The radial alignment also makes the central island more conspicuous to approaching drivers.

If it is not possible to align the legs through the center point, a slight offset to the left (i.e., the centerline passes to the left of the roundabout's center point) is acceptable. This alignment will still allow sufficient curvature to be achieved at the entry, which is of supreme importance. In some cases (particularly when the inscribed circle is relatively small), it may be beneficial to introduce a slight offset of the approaches to the left in order to enhance the entry curvature. However, care must be taken to ensure that such an approach offset does not produce an excessively tangential exit. Especially in urban environments, it is important that the exit

Roundabouts are optimally located when all approach centerlines pass through the center of the inscribed circle.

geometry produce a sufficiently curved exit path in order to keep vehicle speeds low and reduce the risk for pedestrians.

It is almost never acceptable for an approach alignment to be offset to the right of the roundabout's center point. This alignment brings the approach in at a more tangential angle and reduces the opportunity to provide sufficient entry curvature. Vehicles will be able to enter the roundabout too fast, resulting in more loss-of-control crashes and higher crash rates between entering and circulating vehicles. Exhibit 6-18 illustrates the preferred radial alignment of entries.

Approach alignment should not be offset to the right of the roundabout's center point.

In addition, it is desirable to equally space the angles between entries. This provides optimal separation between successive entries and exits. This results in optimal angles of 90 degrees for four-leg roundabouts, 72 degrees for five-leg roundabouts, and so on. This is consistent with findings of the British accident prediction models described in Chapter 5.

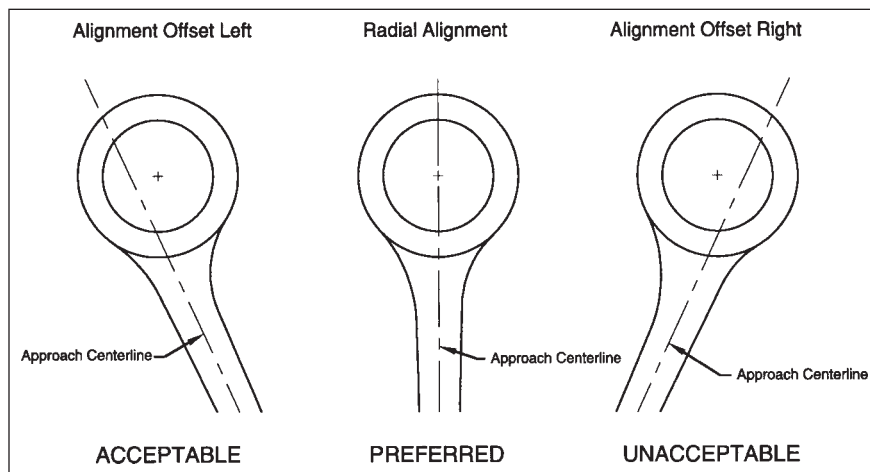

Exhibit 6-18. Radial alignment of entries.

6.3 Geometric Elements

This section presents specific parameters and guidelines for the design of each geometric element of a roundabout. The designer must keep in mind, however, that these components are not independent of each other. The interaction between the components of the geometry is far more important than the individual pieces. Care must be taken to ensure that the geometric elements are all compatible with each other so that the overall safety and capacity objectives are met.

6.3.1 Inscribed circle diameter

The inscribed circle diameter is the distance across the circle inscribed by the outer curb (or edge) of the circulatory roadway. As illustrated in Exhibit 6-1, it is the sum of the central island diameter (which includes the apron, if present) and twice the circulatory roadway. The inscribed circle diameter is determined by a number of design objectives. The designer often has to experiment with varying diameters before determining the optimal size at a given location.

For a single-lane roundabout, the minimum inscribed circle diameter is 30 m (100 ft) to accommodate a WB-15 (WB-50) vehicle.

At single-lane roundabouts, the size of the inscribed circle is largely dependent upon the turning requirements of the design vehicle. The diameter must be large enough to accommodate the design vehicle while maintaining adequate deflection curvature to ensure safe travel speeds for smaller vehicles. However, the circulatory roadway width, entry and exit widths, entry and exit radii, and entry and exit angles also play a significant role in accommodating the design vehicle and providing deflection. Careful selection of these geometric elements may allow a smaller inscribed circle diameter to be used in constrained locations. In general, the inscribed circle diameter should be a *minimum* of 30 m (100 ft) to accommodate a WB-15 (WB-50) design vehicle. Smaller roundabouts can be used for some local street or collector street intersections, where the design vehicle may be a bus or single-unit truck.

For a double-lane roundabout, the minimum inscribed circle diameter is 45 m (150 ft).

At double-lane roundabouts, accommodating the design vehicle is usually not a constraint. The size of the roundabout is usually determined either by the need to achieve deflection or by the need to fit the entries and exits around the circumference with reasonable entry and exit radii between them. Generally, the inscribed circle diameter of a double-lane roundabout should be a *minimum* of 45 m (150 ft).

In general, smaller inscribed diameters are better for overall safety because they help to maintain lower speeds. In high-speed environments, however, the design of the approach geometry is more critical than in low-speed environments. Larger inscribed diameters generally allow for the provision of better approach geometry, which leads to a decrease in vehicle approach speeds. Larger inscribed diameters also reduce the angle formed between entering and circulating vehicle paths, thereby reducing the relative speed between these vehicles and leading to reduced entering-circulating crash rates (2). Therefore, roundabouts in high-speed environments may require diameters that are somewhat larger than those recommended for low-speed environments. Very large diameters (greater than 60 m [200 ft]), however, should generally not be used because they will have high circulating speeds and more crashes with greater severity. Exhibit 6-19 provides recommended ranges of inscribed circle diameters for various site locations.

Exhibit 6-19. Recommended inscribed circle diameter ranges.

Site Category	Typical Design Vehicle	Inscribed Circle Diameter Range*
Mini-Roundabout	Single-Unit Truck	13–25m (45–80 ft)
Urban Compact	Single-Unit Truck/Bus	25–30m (80–100 ft)
Urban Single Lane	WB-15 (WB-50)	30–40m (100–130 ft)
Urban Double Lane	WB-15 (WB-50)	45–55m (150–180 ft)
Rural Single Lane	WB-20 (WB-67)	35–40m (115–130 ft)
Rural Double Lane	WB-20 (WB-67)	55–60m (180–200 ft)

* Assumes 90-degree angles between entries and no more than four legs.

6.3.2 Entry width

Entry width is the largest determinant of a roundabout's capacity. The capacity of an approach is not dependent merely on the number of entering lanes, but on the total width of the entry. In other words, the entry capacity increases steadily with incremental increases to the entry width. Therefore, the basic sizes of entries and circulatory roadways are generally described in terms of *width*, not number of lanes. Entries that are of sufficient width to accommodate multiple traffic streams (at least 6.0 m [20 ft]) are striped to designate separate lanes. However, the circulatory roadway is usually not striped, even when more than one lane of traffic is expected to circulate (for more details related to roadway markings, see Chapter 7).

As shown in Exhibit 6-1, entry width is measured from the point where the yield line intersects the left edge of the traveled-way to the right edge of the traveled-way, along a line perpendicular to the right curb line. The width of each entry is dictated by the needs of the entering traffic stream. It is based on design traffic volumes and can be determined in terms of the number of entry lanes by using Chapter 4 of this guide. The circulatory roadway must be at least as wide as the widest entry and must maintain a constant width throughout.

To maximize the roundabout's safety, entry widths should be kept to a minimum. The capacity requirements and performance objectives will dictate that each entry be a certain width, with a number of entry lanes. In addition, the turning requirements of the design vehicle may require that the entry be wider still. However, larger entry and circulatory widths increase crash frequency. Therefore, determining the entry width and circulatory roadway width involves a trade-off between capacity and safety. The design should provide the minimum width necessary for capacity and accommodation of the design vehicle in order to maintain the highest level of safety. Typical entry widths for single-lane entrances range from 4.3 to 4.9 m (14 to 16 ft); however, values higher or lower than this range may be required for site-specific design vehicle and speed requirements for critical vehicle paths.

When the capacity requirements can only be met by increasing the entry width, this can be done in two ways:

1. By adding a full lane upstream of the roundabout and maintaining parallel lanes through the entry geometry; or
2. By widening the approach gradually (flaring) through the entry geometry.

Exhibit 6-20 and Exhibit 6-21 illustrate these two widening options.

Entry width is the largest determinant of a roundabout's capacity.

Entry widths should be kept to a minimum to maximize safety while achieving capacity and performance objectives.

Exhibit 6-20. Approach widening by adding full lane.

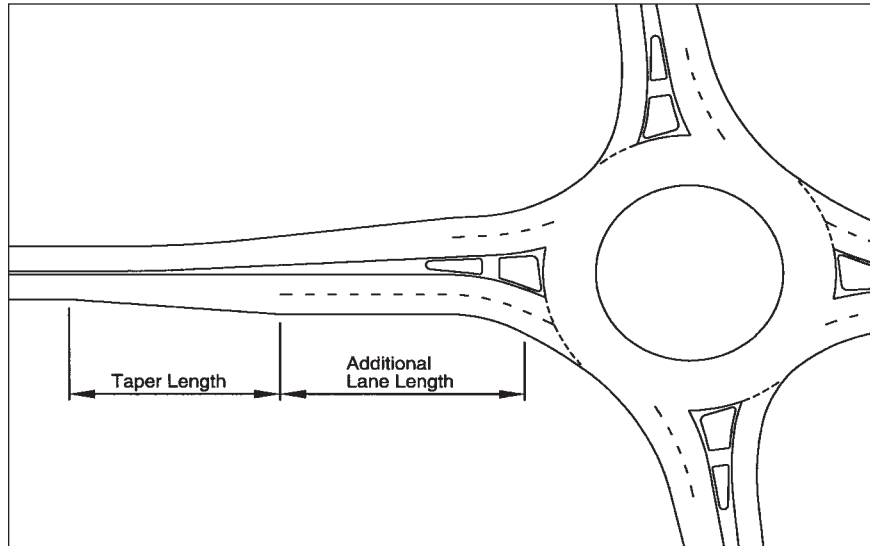
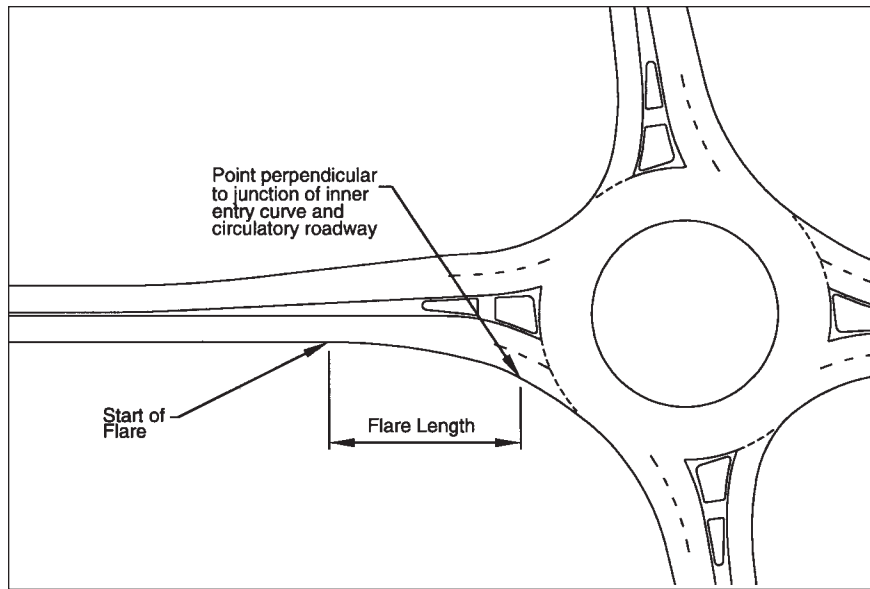

Exhibit 6-21. Approach widening by entry flaring.



Flare lengths should be at least 25 m in urban areas and 40 m in rural areas.

As discussed in Chapter 4, flaring is an effective means of increasing capacity without requiring as much right-of-way as a full lane addition. While increasing the length of flare increases capacity, it does not increase crash frequency. Consequently, the crash frequency for two approaches with the same entry width will be essentially the same, whether they have parallel entry lanes or flared entry designs. Entry widths should therefore be minimized and flare lengths maximized to achieve the desired capacity with minimal effect on crashes. Generally, flare lengths should be a minimum of 25 m (80 ft) in urban areas and 40 m (130 ft) in rural areas. However, if right-of-way is constrained, shorter lengths can be used with noticeable effects on capacity (see Chapter 4).

In some cases, a roundabout designed to accommodate design year traffic volumes, typically projected 20 years from the present, can result in substantially wider entries and circulatory roadway than needed in the earlier years of operation. Because safety will be significantly reduced by the increase in entry width, the designer may wish to consider a two-phase design solution. In this case, the first-phase design would provide the entry width requirements for near-term traffic volumes with the ability to easily expand the entries and circulatory roadway to accommodate future traffic volumes. The interim solution should be accomplished by first laying out the ultimate plan, then designing the first phase within the ultimate curb lines. The interim roundabout is often constructed with the ultimate inscribed circle diameter, but with a larger central island and splitter islands. At the time additional capacity is needed, the splitter and central islands can be reduced in size to provide additional widths at the entries, exits, and circulatory roadway.

Two-phase designs allow for small initial entry widths that can be easily expanded in the future when needed to accommodate greater traffic volumes.

6.3.3 Circulatory roadway width

The required width of the circulatory roadway is determined from the width of the entries and the turning requirements of the design vehicle. In general, it should always be at least as wide as the maximum entry width (up to 120 percent of the maximum entry width) and should remain constant throughout the roundabout (3).

6.3.3.1 Single-lane roundabouts

At single-lane roundabouts, the circulatory roadway should just accommodate the design vehicle. Appropriate vehicle-turning templates or a CAD-based computer program should be used to determine the swept path of the design vehicle through each of the turning movements. Usually the left-turn movement is the critical path for determining circulatory roadway width. In accordance with AASHTO policy, a minimum clearance of 0.6 m (2 ft) should be provided between the outside edge of the vehicle's tire track and the curb line. AASHTO Table III-19 (1994 edition) provides derived widths required for various radii for each standard design vehicle.

In some cases (particularly where the inscribed diameter is small or the design vehicle is large) the turning requirements of the design vehicle may dictate that the circulatory roadway be so wide that the amount of deflection necessary to slow passenger vehicles is compromised. In such cases, the circulatory roadway width can be reduced and a truck apron, placed behind a mountable curb on the central island, can be used to accommodate larger vehicles. However, truck aprons generally provide a lower level of operation than standard nonmountable islands. They are sometimes driven over by four-wheel drive automobiles, may surprise inattentive motorcyclists, and can cause load shifting on trucks. They should, therefore, be used only when there is no other means of providing adequate deflection while accommodating the design vehicle.

Truck aprons generally provide a lower level of operations, but may be needed to provide adequate deflection while still accommodating the design vehicle.

6.3.3.2 Double-lane roundabouts

At double-lane roundabouts, the circulatory roadway width is usually not governed by the design vehicle. The width required for one, two, or three vehicles, depending on the number of lanes at the widest entry, to travel simultaneously through the roundabout should be used to establish the circulatory roadway width. The

combination of vehicle types to be accommodated side-by-side is dependent upon the specific traffic conditions at each site. If the entering traffic is predominantly passenger cars and single-unit trucks (AASHTO P and SU vehicles), where semi-trailer traffic is infrequent, it may be appropriate to design the width for two passenger vehicles or a passenger car and a single-unit truck side-by-side. If semi-trailer traffic is relatively frequent (greater than 10 percent), it may be necessary to provide sufficient width for the simultaneous passage of a semi-trailer in combination with a P or SU vehicle.

Exhibit 6-22 provides minimum recommended circulatory roadway widths for two-lane roundabouts where semi-trailer traffic is relatively infrequent.

Exhibit 6-22. Minimum circulatory lane widths for two-lane roundabouts.

Inscribed Circle Diameter	Minimum Circulatory Lane Width*	Central Island Diameter
45 m (150 ft)	9.8 m (32 ft)	25.4 m (86 ft)
50 m (165 ft)	9.3 m (31 ft)	31.4 m (103 ft)
55 m (180 ft)	9.1 m (30 ft)	36.8 m (120 ft)
60 m (200 ft)	9.1 m (30 ft)	41.8 m (140 ft)
65 m (215 ft)	8.7 m (29 ft)	47.6 m (157 ft)
70 m (230 ft)	8.7 m (29 ft)	52.6 m (172 ft)

* Based on 1994 AASHTO Table III-20, Case III(A) (4). Assumes infrequent semi-trailer use (typically less than 5 percent of the total traffic). Refer to AASHTO for cases with higher truck percentages.

6.3.4 Central island

The central island of a roundabout is the raised, nontraversable area encompassed by the circulatory roadway; this area may also include a traversable apron. The island is typically landscaped for aesthetic reasons and to enhance driver recognition of the roundabout upon approach. Central islands should always be raised, not depressed, as depressed islands are difficult for approaching drivers to recognize.

In general, the central island should be circular in shape. A circular-shaped central island with a constant-radius circulatory roadway helps promote constant speeds around the central island. Oval or irregular shapes, on the other hand, are more difficult to drive and can promote higher speeds on the straight sections and reduced speeds on the arcs of the oval. This speed differential may make it harder for entering vehicles to judge the speed and acceptability of gaps in the circulatory traffic stream. It can also be deceptive to circulating drivers, leading to more loss-of-control crashes. Noncircular central islands have the above disadvantages to a rapidly increasing degree as they get larger because circulating speeds are higher. Oval shapes are generally not such a problem if they are relatively small and speeds are low. Raindrop-shaped islands may be used in areas where certain movements do not exist, such as interchanges (see Chapter 8), or at locations where certain turning movements cannot be safely accommodated, such as roundabouts with one approach on a relatively steep grade.

As described in Section 6.2.1, the size of the central island plays a key role in determining the amount of deflection imposed on the through vehicle's path. However, its diameter is entirely dependent upon the inscribed circle diameter and the required circulatory roadway width (see Sections 6.3.1 and 6.3.3, respectively). Therefore, once the inscribed diameter, circulatory roadway width, and initial entry geometry have been established, the fastest vehicle path must be drawn through the layout, as described in Section 6.2.1.3, to determine if the central island size is adequate. If the fastest path exceeds the design speed, the central island size may need to be increased, thus increasing the overall inscribed circle diameter. There may be other methods for increasing deflection without increasing the inscribed diameter, such as offsetting the approach alignment to the left, reducing the entry width, or reducing the entry radius. These treatments, however, may preclude the ability to accommodate the design vehicle.

In cases where right-of-way, topography, or other constraints preclude the ability to expand the inscribed circle diameter, a mountable apron may be added to the outer edge of the central island. This provides additional paved area to allow the over-tracking of large semi-trailer vehicles on the central island without compromising the deflection for smaller vehicles. Exhibit 6-23 shows a typical central island with a traversable apron.

Where aprons are used, they should be designed so that they are traversable by trucks, but discourage passenger vehicles from using them. They should generally be 1 to 4 m (3 to 13 ft) wide and have a cross slope of 3 to 4 percent away from the central island. To discourage use by passenger vehicles, the outer edge of the apron should be raised a minimum of 30 mm (1.2 in) above the circulatory roadway surface (6). The apron should be constructed of colored and/or textured paving



Leeds, MD

Exhibit 6-23. Example of central island with a traversable apron.

materials to differentiate it from the circulatory roadway. Care must be taken to ensure that delivery trucks will not experience load shifting as their rear trailer wheels track across the apron.

Issues regarding landscaping and other treatments within the central island are discussed in Chapter 7.

In general, roundabouts in rural environments typically need larger central islands than urban roundabouts in order to enhance their visibility and to enable the design of better approach geometry (2).

6.3.5 Entry curves

As shown in Exhibit 6-1, the entry curves are the set of one or more curves along the right curb (or edge of pavement) of the entry roadway leading into the circulatory roadway. It should not be confused with the *entry path curve*, defined by the radius of the fastest vehicular travel path through the entry geometry (R_1 , on Exhibit 6-12).

The entry radius is an important factor in determining the operation of a roundabout as it has significant impacts on both capacity and safety. The entry radius, in conjunction with the entry width, the circulatory roadway width, and the central island geometry, controls the amount of deflection imposed on a vehicle's entry path. Larger entry radii produce faster entry speeds and generally result in higher crash rates between entering and circulating vehicles. In contrast, the operational performance of roundabouts benefits from larger entry radii. As described in Chapter 4, British research has found that the capacity of an entry increases as its entry radius is increased (up to 20 m [65 ft], beyond which entry radius has little effect on capacity).

The entry curve is designed curvilinearly tangential to the outside edge of the circulatory roadway. Likewise, the projection of the inside (left) edge of the entry roadway should be curvilinearly tangential to the central island. Exhibit 6-24 shows a typical roundabout entrance geometry.

The primary objective in selecting a radius for the entry curve is to achieve the speed objectives, as described in Section 6.2.1. The entry radius should first produce an appropriate design speed on the fastest vehicular path. Second, it should desirably result in an entry path radius (R_1) equal to or less than the circulating path radius (R_2) (see Section 6.2.1.5).

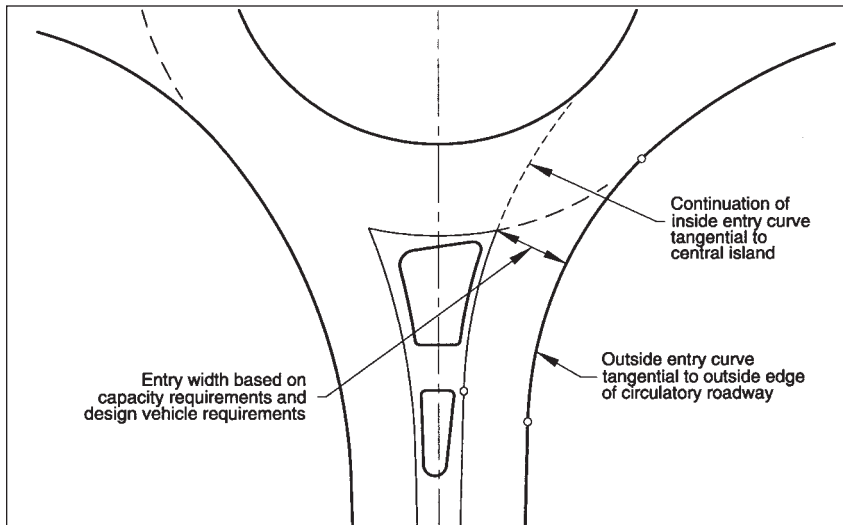

Exhibit 6-24. Single-lane roundabout entry design.

6.3.5.1 Entry curves at single-lane roundabouts

For single-lane roundabouts, it is relatively simple to achieve the entry speed objectives. With a single traffic stream entering and circulating, there is no conflict between traffic in adjacent lanes. Thus, the entry radius can be reduced or increased as necessary to produce the desired entry path radius. Provided sufficient clearance is given for the design vehicle, approaching vehicles will adjust their path accordingly and negotiate through the entry geometry into the circulatory roadway.

Entry radii at urban single-lane roundabouts typically range from 10 to 30 m (33 to 98 ft). Larger radii may be used, but it is important that the radii not be so large as to result in excessive entry speeds. At local street roundabouts, entry radii may be below 10 m (33 ft) if the design vehicle is small.

At rural and suburban locations, consideration should be given to the speed differential between the approaches and entries. If the difference is greater than 20 km/h (12 mph), it is desirable to introduce approach curves or some other speed reduction measures to reduce the speed of approaching traffic prior to the entry curvature. Further details on rural roundabout design are provided in Section 6.5.

6.3.5.2 Entry curves at double-lane roundabouts

At double-lane roundabouts, the design of the entry curvature is more complicated. Overly small entry radii can result in conflicts between adjacent traffic streams. This conflict usually results in poor lane utilization of one or more lanes and significantly reduces the capacity of the approach. It can also degrade the safety performance as sideswipe crashes may increase. Techniques and guidelines for avoiding conflicts between adjacent entry lanes at double-lane roundabouts are provided in Section 6.4.

6.3.6 Exit curves

Exit curves usually have larger radii than entry curves to minimize the likelihood of congestion at the exits. This, however, is balanced by the need to maintain low speeds at the pedestrian crossing on exit. The exit curve should produce an *exit path radius* (R_3 in Exhibit 6-12) no smaller than the circulating path radius (R_2). If the exit path radius is smaller than the circulating path radius, vehicles will be traveling too fast to negotiate the exit geometry and may crash into the splitter island or into oncoming traffic in the adjacent approach lane. Likewise, the exit path radius should not be significantly greater than the circulating path radius to ensure low speeds at the downstream pedestrian crossing.

The exit curve is designed to be curvilinearly tangential to the outside edge of the circulatory roadway. Likewise, the projection of the inside (left) edge of the exit roadway should be curvilinearly tangential to the central island. Exhibit 6-25 shows a typical exit layout for a single-lane roundabout.

Exhibit 6-25. Single-lane roundabout exit design.

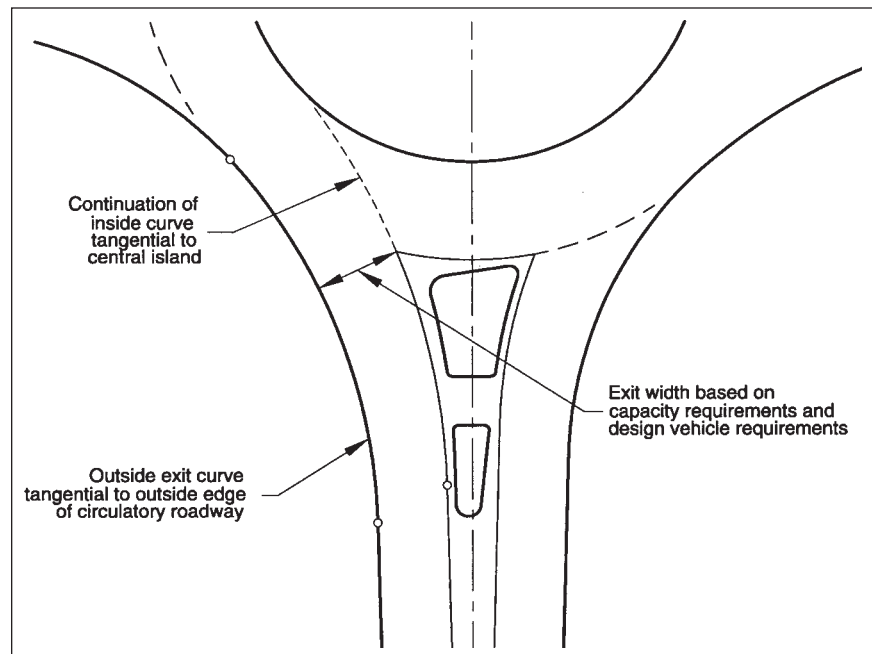

6.3.6.1 Exit curves at single-lane roundabouts

At single-lane roundabouts in urban environments, exits should be designed to enforce a curved exit path with a design speed below 40 km/h (25 mph) in order to maximize safety for pedestrians crossing the exiting traffic stream. Generally, exit radii should be no less than 15 m (50 ft). However, at locations with pedestrian activity and no large semi-trailer traffic, exit radii may be as low as 10 to 12 m (33 to 39 ft). This produces a very slow design speed to maximize safety and comfort for pedestrians. Such low exit radii should only be used in conjunction with similar or smaller entry radii on urban compact roundabouts with inscribed circle diameters below 35 m (115 ft).

In rural locations where there are few pedestrians, exit curvature may be designed with large radii, allowing vehicles to exit quickly and accelerate back to traveling speed. This, however, should not result in a straight path tangential to the central island because many locations that are rural today become urban in the future. Therefore, it is recommended that pedestrian activity be considered at all exits except where separate pedestrian facilities (paths, etc.) or other restrictions eliminate the likelihood of pedestrian activity in the foreseeable future.

6.3.6.2 Exit curves at double-lane roundabouts

As with the entries, the design of the exit curvature at double-lane roundabouts is more complicated than at single-lane roundabouts. Techniques and guidelines for avoiding conflicts between adjacent exit lanes at double-lane roundabouts are provided in Section 6.4.

6.3.7 Pedestrian crossing location and treatments

Pedestrian crossing locations at roundabouts are a balance among pedestrian convenience, pedestrian safety, and roundabout operations:

- *Pedestrian convenience:* Pedestrians want crossing locations as close to the intersection as possible to minimize out-of-direction travel. The further the crossing is from the roundabout, the more likely that pedestrians will choose a shorter route that may put them in greater danger.
- *Pedestrian safety:* Both crossing location and crossing distance are important. Crossing distance should be minimized to reduce exposure of pedestrian-vehicle conflicts. Pedestrian safety may also be compromised at a yield-line crosswalk because driver attention is directed to the left to look for gaps in the circulating traffic stream. Crosswalks should be located to take advantage of the splitter island; crosswalks located too far from the yield line require longer splitter islands. Crossings should also be located at distances away from the yield line measured in increments of approximate vehicle length to reduce the chance that vehicles will be queued across the crosswalk.

Pedestrian crossing locations must balance pedestrian convenience, pedestrian safety, and roundabout operations.

- *Roundabout operations:* Roundabout operations (primarily vehicular) can also be affected by crosswalk locations, particularly on the exit. A queuing analysis at the exit crosswalk may determine that a crosswalk location of more than one vehicle length away may be required to reduce to an acceptable level the risk of queuing into the circulatory roadway. Pedestrians may be able to distinguish exiting vehicles from circulating vehicles (both visually and audibly) at crosswalk locations further away from the roundabout, although this has not been confirmed by research.

With these issues in mind, pedestrian crossings should be designed as follows:

- The pedestrian refuge should be a minimum width of 1.8 m (6 ft) to adequately provide shelter for persons pushing a stroller or walking a bicycle (see Section 6.2.3).
- At single-lane roundabouts, the pedestrian crossing should be located one vehicle-length (7.5 m [25 ft]) away from the yield line. At double-lane roundabouts, the pedestrian crossing should be located one, two, or three car lengths (approximately 7.5 m, 15 m, or 22.5 m [25 ft, 50 ft, or 75 ft]) away from the yield line.
- The pedestrian refuge should be designed at street level, rather than elevated to the height of the splitter island. This eliminates the need for ramps within the refuge area, which can be cumbersome for wheelchairs.
- Ramps should be provided on each end of the crosswalk to connect the crosswalk to other crosswalks around the roundabout and to the sidewalk network.
- It is recommended that a detectable warning surface, as recommended in the Americans with Disabilities Act Accessibility Guidelines (ADAAG) §4.29 (Detectable Warnings), be applied to the surface of the refuge within the splitter island as shown in Exhibit 6-26. Note that the specific provision of the ADAAG requiring detectable warning surface at locations such as ramps and splitter islands (defined in the ADAAG as “hazardous vehicle areas”) has been suspended until July 26, 2001 (ADAAG §4.29.5). Where used, a detectable warning surface shall meet the following requirements (7):
 - The detectable warning surface shall consist of raised truncated domes with a nominal diameter of 23 mm (0.9 in), a nominal height of 5 mm (0.2 in), and a nominal center-to-center spacing of 60 mm (2.35 in).
 - The detectable warning surface shall contrast visually with adjoining surfaces, either light-on-dark or dark-on-light. The material used to provide contrast shall be an integral part of the walking surface.
 - The detectable warning surface shall begin at the curb line and extend into the pedestrian refuge area a distance of 600 mm (24 in). This creates a minimum 600-mm (24-in) clear space between detectable warning surfaces for a minimum splitter island width of 1.8 m (6 ft) at the pedestrian crossing. This is a deviation from the requirements of (suspended) ADAAG §4.29.5, which requires a 915-mm (36-in) surface width. However, this deviation is necessary to enable visually impaired pedestrians to distinguish the two interfaces with vehicular traffic.

Detectable warning surfaces should be applied within the pedestrian refuge.

In urban areas, speed tables (flat-top road humps) could be considered for wheelchair users, provided that good geometric design has reduced absolute vehicle

speeds to less than 20 km/h (12 mph) near the crossing. Pedestrian crossings across speed tables must have detectable warning material as described above to clearly delineate the edge of the street. Speed tables should generally be used only on streets with approach speeds of 55 km/h (35 mph) or less, as the introduction of a raised speed table in higher speed environments may increase the likelihood of single-vehicle crashes and is not consistent with the speed consistency philosophy presented in this document.

6.3.8 Splitter islands

Splitter islands (also called *separator islands* or *median islands*) should be provided on all roundabouts, except those with very small diameters at which the splitter island would obstruct the visibility of the central island. Their purpose is to provide shelter for pedestrians (including wheelchairs, bicycles, and baby strollers), assist in controlling speeds, guide traffic into the roundabout, physically separate entering and exiting traffic streams, and deter wrong-way movements. Additionally, splitter islands can be used as a place for mounting signs (see Chapter 7).

The splitter island envelope is formed by the entry and exit curves on a leg, as shown previously in Exhibits 6-24 and 6-25. The total length of the island should generally be at least 15 m (50 ft) to provide sufficient protection for pedestrians and to alert approaching drivers to the roundabout geometry. Additionally, the splitter island should extend beyond the end of the exit curve to prevent exiting traffic from accidentally crossing into the path of approaching traffic.

Exhibit 6-26 shows the minimum dimensions for a splitter island at a single-lane roundabout, including the location of the pedestrian crossing as discussed in Section 6.3.7.

Splitter islands perform multiple functions and should generally be provided.

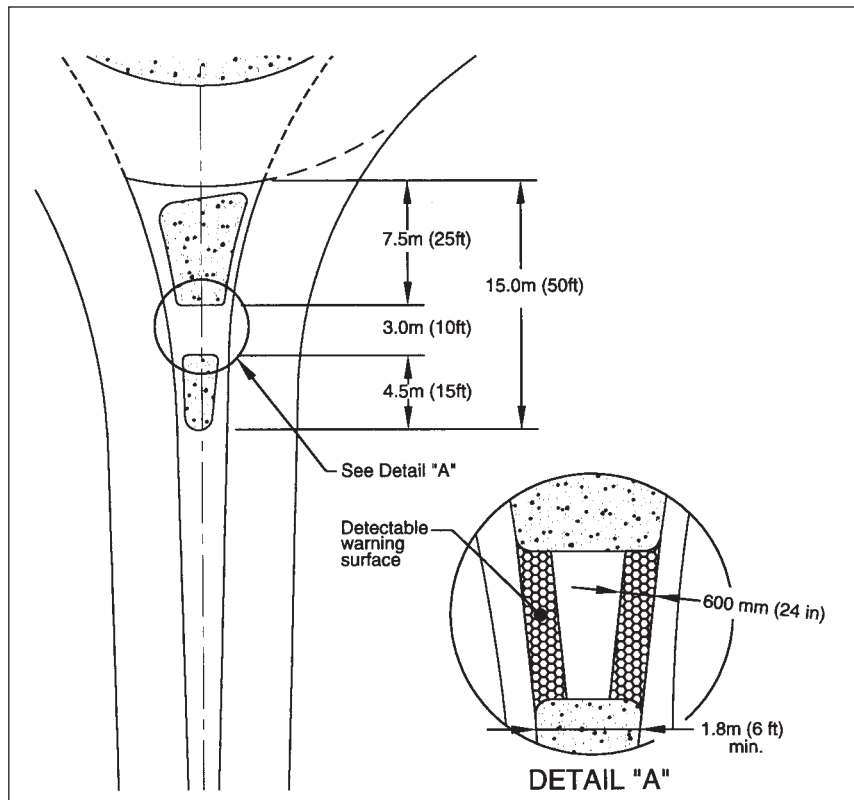

Exhibit 6-26. Minimum splitter island dimensions.

Larger splitter islands enhance safety, but require that the inscribed circle diameter be increased.

While Exhibit 6-26 provides minimum dimensions for splitter islands, there are benefits to providing larger islands. Increasing the splitter island width results in greater separation between the entering and exiting traffic streams of the same leg and increases the time for approaching drivers to distinguish between exiting and circulating vehicles. In this way, larger splitter islands can help reduce confusion for entering motorists. A recent study by the Queensland Department of Main Roads found that maximizing the width of splitter islands has a significant effect on minimizing entering/circulating vehicle crash rates (2). However, increasing the width of the splitter islands generally requires increasing the inscribed circle diameter. Thus, these safety benefits may be offset by higher construction cost and greater land impacts.

Standard AASHTO guidelines for island design should be followed for the splitter island. This includes using larger nose radii at approach corners to maximize island visibility and offsetting curb lines at the approach ends to create a funneling effect. The funneling treatment also aids in reducing speeds as vehicles approach the roundabout. Exhibit 6-27 shows minimum splitter island nose radii and offset dimensions from the entry and exit traveled ways.

Exhibit 6-27. Minimum splitter island nose radii and offsets.

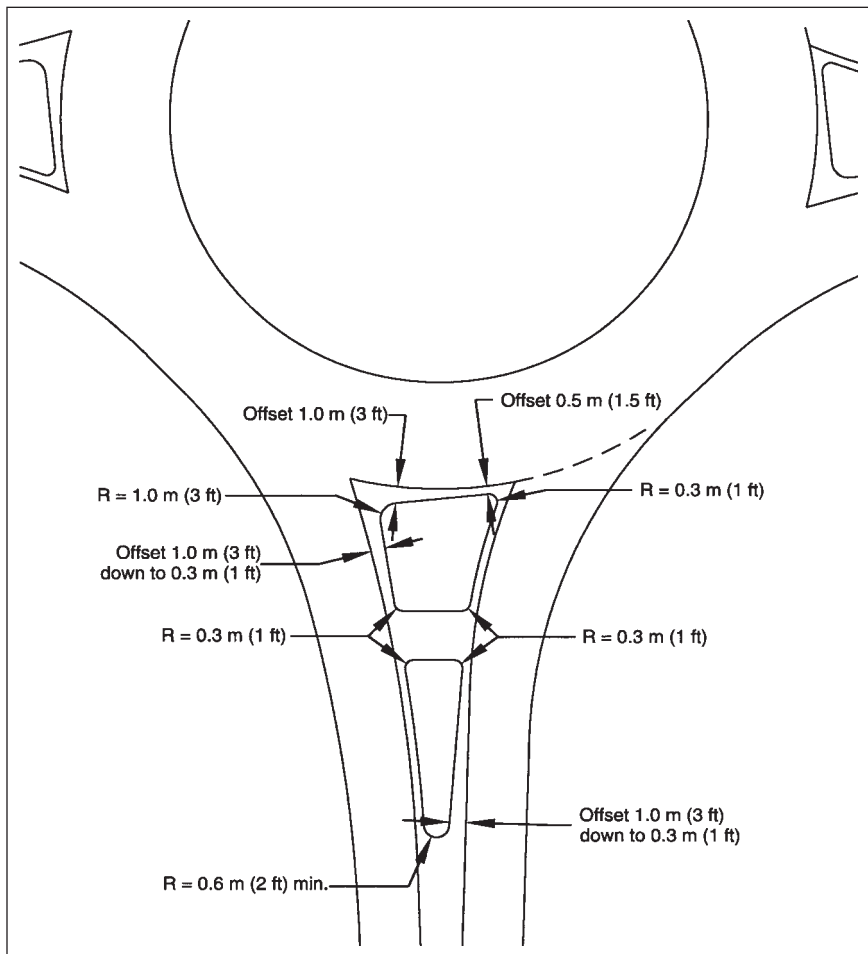

6.3.9 Stopping sight distance

Stopping sight distance is the distance along a roadway required for a driver to perceive and react to an object in the roadway and to brake to a complete stop before reaching that object. Stopping sight distance should be provided at every point within a roundabout and on each entering and exiting approach.

National Cooperative Highway Research Program (NCHRP) Report 400, *Determination of Stopping Sight Distances* (8), recommends the formula given in Equation 6-2 for determining stopping sight distance (presented in metric units, followed by a conversion of the equation to U.S. customary units).

$$d = (0.278)(t)(V) + 0.039 \frac{V^2}{a} \quad (6-2a, \text{ metric})$$

where: d = stopping sight distance, m;
t = perception-brake reaction time, assumed to be 2.5 s;
V = initial speed, km/h; and
a = driver deceleration, assumed to be 3.4 m/s².

$$d = (1.468)(t)(V) + 1.087 \frac{V^2}{a}$$

where: d = stopping sight distance, ft;
t = perception-brake reaction time, assumed to be 2.5 s;
V = initial speed, mph; and
a = driver deceleration, assumed to be 11.2 ft/s².

Exhibit 6-28 gives recommended stopping sight distances for design, as computed from the above equations.

Speed (km/h)	Computed Distance* (m)	Speed (mph)	Computed Distance* (ft)
10	8.1	10	46.4
20	18.5	15	77.0
30	31.2	20	112.4
40	46.2	25	152.7
50	63.4	30	197.8
60	83.0	35	247.8
70	104.9	40	302.7
80	129.0	45	362.
90	155.5	50	427.2
100	184.2 *	55	496.7

Exhibit 6-28. Design values for stopping sight distances.

Assumes 2.5 s perception-braking time, 3.4 m/s² (11.2 ft/s²) driver deceleration

Stopping sight distance should be measured using an assumed height of driver's eye of 1,080 mm (3.54 ft) and an assumed height of object of 600 mm (1.97 ft) in accordance with the recommendations to be adopted in the next AASHTO "Green Book" (8).

At least three critical types of locations should be checked for stopping sight distance.

At roundabouts, three critical types of locations should be checked at a minimum:

- Approach sight distance (Exhibit 6-29);
- Sight distance on circulatory roadway (Exhibit 6-30); and
- Sight distance to crosswalk on exit (Exhibit 6-31).

Forward sight distance at entry can also be checked; however, this will typically be satisfied by providing adequate stopping sight distance on the circulatory roadway itself.

Exhibit 6-29. Approach sight distance.

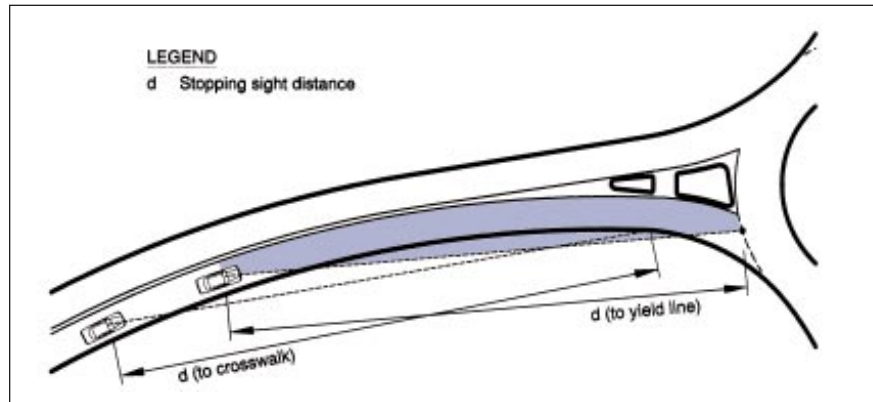
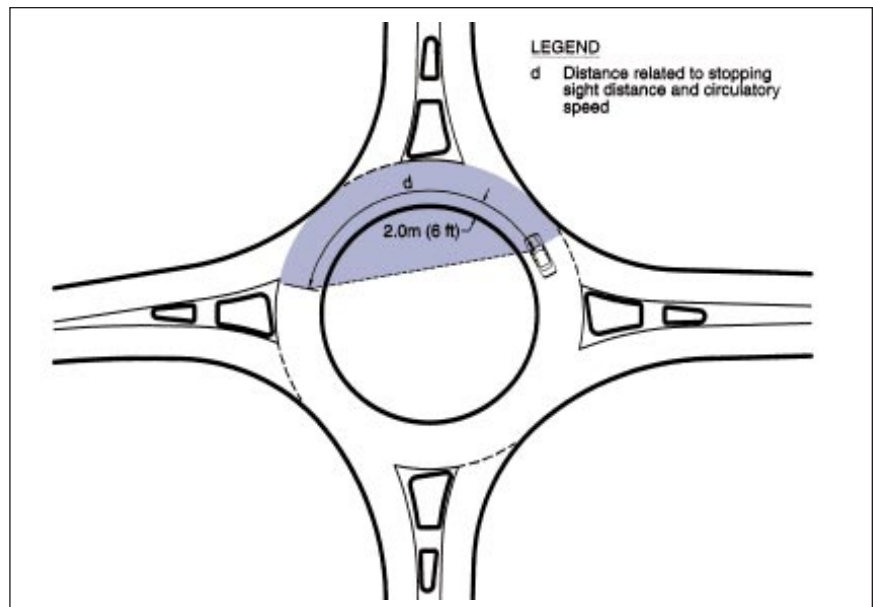

Exhibit 6-30. Sight distance on circulatory roadway.



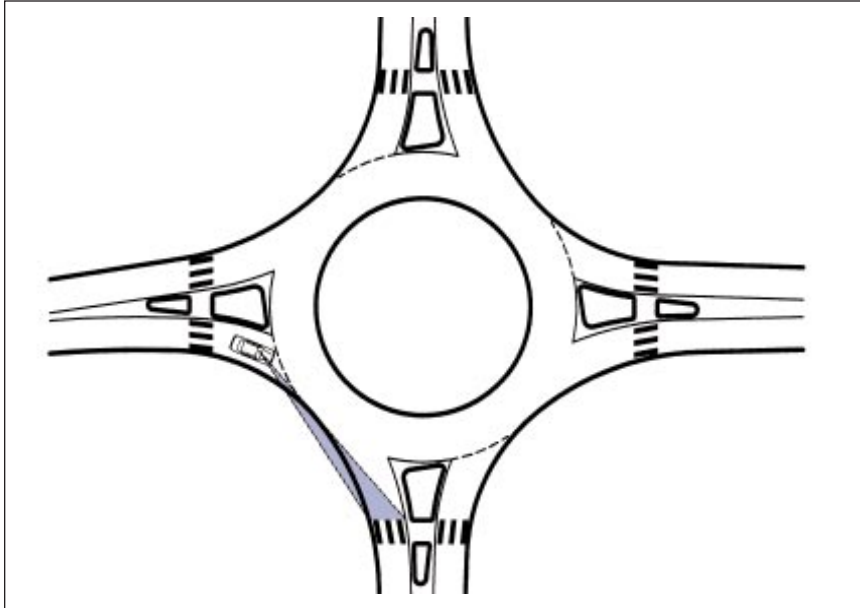

Exhibit 6-31. Sight distance to crosswalk on exit.

6.3.10 Intersection sight distance

Intersection sight distance is the distance required for a driver without the right of way to perceive and react to the presence of conflicting vehicles. Intersection sight distance is achieved through the establishment of adequate sight lines that allow a driver to see and safely react to potentially conflicting vehicles. At roundabouts, the only locations requiring evaluation of intersection sight distance are the entries.

Roundabout entries require adequate intersection sight distance.

Intersection sight distance is traditionally measured through the determination of a *sight triangle*. This triangle is bounded by a length of roadway defining a limit away from the intersection on each of the two conflicting approaches and by a line connecting those two limits. For roundabouts, these "legs" should be assumed to follow the curvature of the roadway, and thus distances should be measured not as straight lines but as distances along the vehicular path.

Intersection sight distance should be measured using an assumed height of driver's eye of 1,080 mm (3.54 ft) and an assumed height of object of 1,080 mm (3.54 ft) in accordance with the recommendations to be adopted in the next AASHTO "Green Book" (4).

Exhibit 6-32 presents a diagram showing the method for determining intersection sight distance. As can be seen in the exhibit, the sight distance "triangle" has two conflicting approaches that must be checked independently. The following two subsections discuss the calculation of the length of each of the approaching sight limits.

Exhibit 6-32. Intersection sight distance

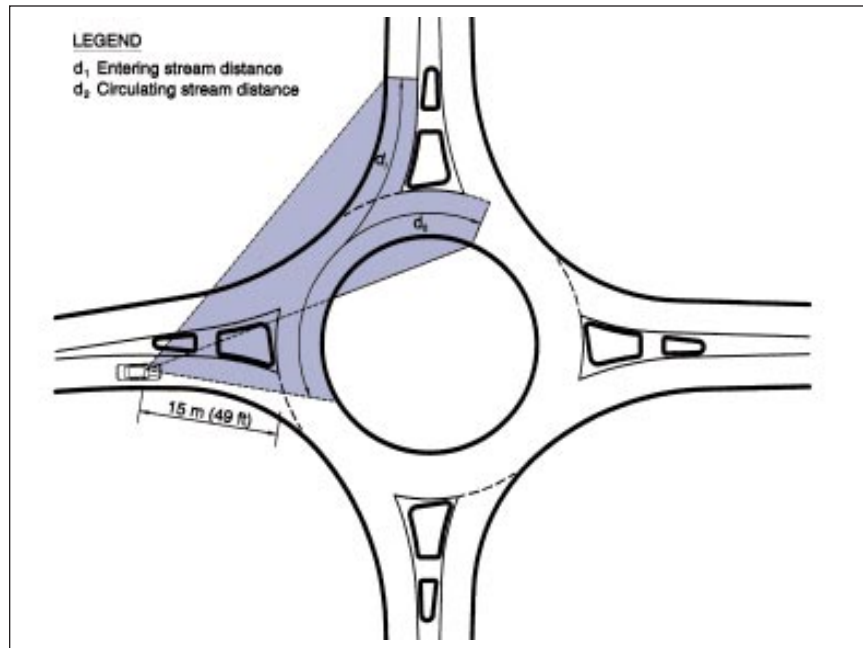

6.3.10.1 Length of approach leg of sight triangle

The length of the approach leg of the sight triangle should be limited to 15 m (49 ft). British research on sight distance determined that excessive intersection sight distance results in a higher frequency of crashes. This value, consistent with British and French practice, is intended to require vehicles to slow down prior to entering the roundabout, which allows them to focus on the pedestrian crossing prior to entry. If the approach leg of the sight triangle is greater than 15 m (49 ft), it may be advisable to add landscaping to restrict sight distance to the minimum requirements.

6.3.10.2 Length of conflicting leg of sight triangle

A vehicle approaching an entry to a roundabout faces conflicting vehicles within the circulatory roadway. The length of the conflicting leg is calculated using Equation 6-3:

$$b = 0.278(V_{major})(t_c) \quad (6-3a, \text{ metric})$$

where: b = length of conflicting leg of sight triangle, m
 V_{major} = design speed of conflicting movement, km/h, discussed below
 t_c = critical gap for entering the major road, s, equal to 6.5 s

$$b = 1.468(V_{major})(t_c) \quad (6-3b, \text{ U.S. customary})$$

where: b = length of conflicting leg of sight triangle, ft
 V_{major} = design speed of conflicting movement, mph, discussed below
 t_c = critical gap for entering the major road, s, equal to 6.5 s

Two conflicting traffic streams should be checked at each entry:

- *Entering stream*, comprised of vehicles from the immediate upstream entry. The speed for this movement can be approximated by taking the average of the entry path speed (path with radius R_1 from Exhibit 6-12) and the circulating path speed (path with radius R_2 from Exhibit 6-12).
- *Circulating stream*, comprised of vehicles that entered the roundabout prior to the immediate upstream entry. This speed can be approximated by taking the speed of left turning vehicles (path with radius R_4 from Exhibit 6-12).

The critical gap for entering the major road is based on the amount of time required for a vehicle to turn right while requiring the conflicting stream vehicle to slow no less than 70 percent of initial speed. This is based on research on critical gaps at stop-controlled intersections, adjusted for yield-controlled conditions (9). The critical gap value of 6.5 s given in Equation 6-3 is based on the critical gap required for passenger cars, which are assumed to be the most critical design vehicle for intersection sight distance. This assumption holds true for single-unit and combination truck speeds that are at least 10 km/h (6 mph) and 15 to 20 km/h (9 to 12 mph) slower than passenger cars, respectively.

Conflicting Approach Speed (km/h)	Computed Distance (m)	Conflicting Approach Speed (mph)	Computed Distance (ft)
20	36.1	10	95.4
25	45.2	15	143.0
30	54.2	20	190.1
35	63.2	25	238.6
40	72.3	30	286.3

Exhibit 6-33. Computed length of conflicting leg of intersection sight triangle.

In general, it is recommended to provide no more than the minimum required intersection sight distance on each approach. Excessive intersection sight distance can lead to higher vehicle speeds that reduce the safety of the intersection for all road users (vehicles, bicycles, pedestrians). Landscaping can be effective in restricting sight distance to the minimum requirements.

Providing more than the minimum required intersection sight distance can lead to higher speeds that reduce intersection safety.

Note that the stopping sight distance on the circulatory roadway (Exhibit 6-30) and the intersection sight distance to the circulating stream (Exhibit 6-32) imply restrictions on the height of the central island, including landscaping and other objects, within these zones. In the remaining central area of the central island, higher landscaping may serve to break the forward vista for through vehicles, thereby contributing to speed reduction. However, should errant vehicles encroach on the central island, Chapter 7 provides recommended maximum grades on the central island to minimize the probability of the vehicles rolling over, causing serious injury.

6.3.11 Vertical considerations

Elements of vertical alignment design for roundabouts include profiles, superelevation, approach grades, and drainage.

6.3.11.1 Profiles

The vertical design of a roundabout begins with the development of approach roadway and central island profiles. The development of each profile is an iterative process that involves tying the elevations of the approach roadway profiles into a smooth profile around the central island.

Generally, each approach profile should be designed to the point where the approach baseline intersects with the central island. A profile for the central island is then developed which passes through these four points (in the case of a four-legged roundabout). The approach roadway profiles are then readjusted as necessary to meet the central island profile. The shape of the central island profile is generally in the form of a sine curve. Examples of how the profile is developed can be found in Exhibits 6-34, 6-35, and 6-36, which consist of a sample plan, profiles on each approach, and a profile along the central island, respectively. Note that the four points where the approach roadway baseline intersects the central island baseline are identified on the central island profile.

Exhibit 6-34. Sample plan view.

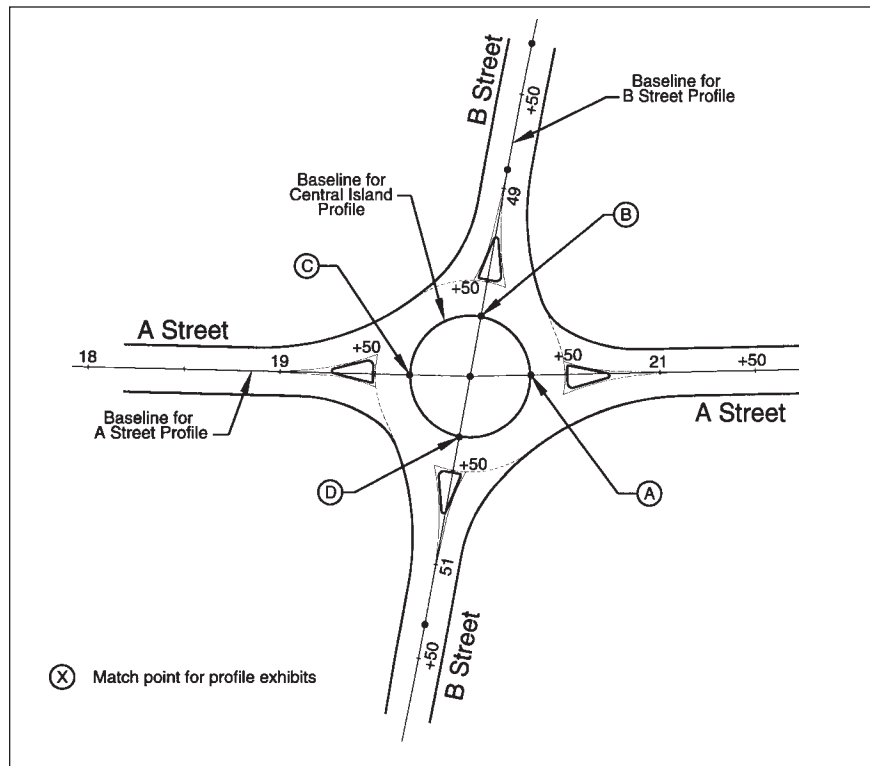

Exhibit 6-35. Sample approach profile.

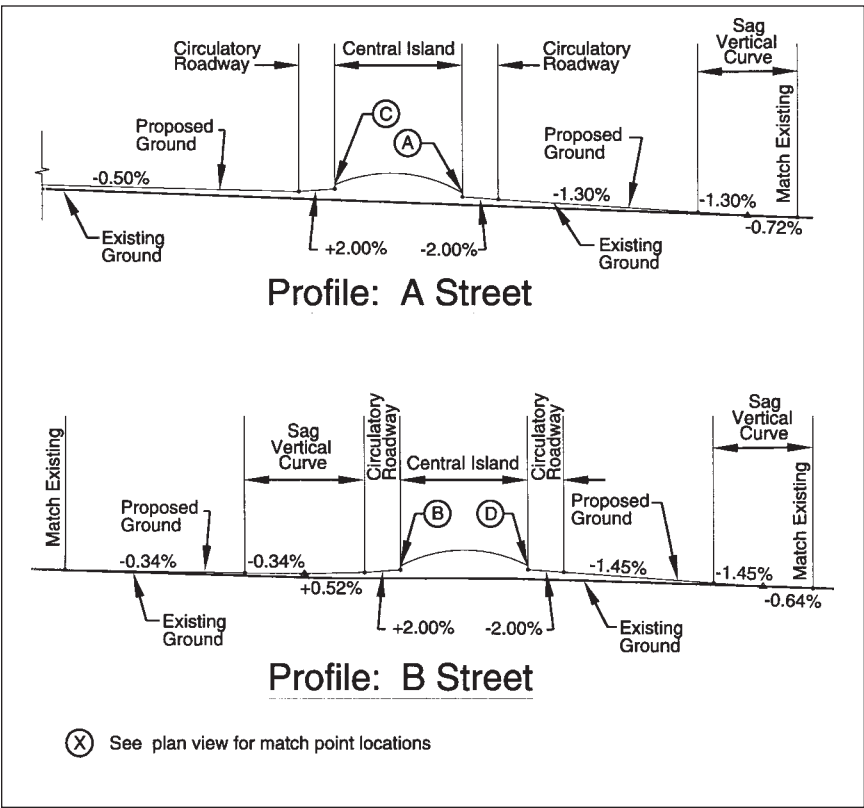
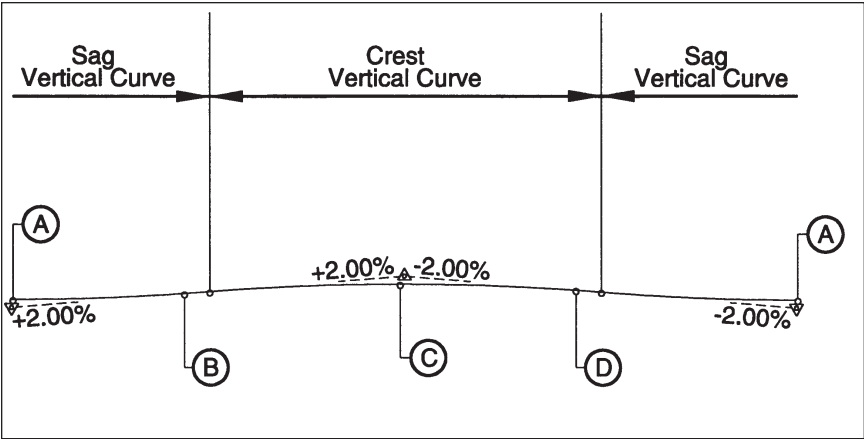

Exhibit 6-36. Sample central island profile.



Negative superelevation (- 2%) should generally be used for the circulatory roadway.

6.3.11.2 Superelevation

As a general practice, a cross slope of 2 percent away from the central island should be used for the circulatory roadway. This technique of sloping outward is recommended for four main reasons:

- It promotes safety by raising the elevation of the central island and improving its visibility;
- It promotes lower circulating speeds;
- It minimizes breaks in the cross slopes of the entrance and exit lanes; and
- It helps drain surface water to the outside of the roundabout (2, 6).

The outward cross slope design means vehicles making through and left-turn movements must negotiate the roundabout at negative superelevation. Excessive negative superelevation can result in an increase in single-vehicle crashes and loss-of-load incidents for trucks, particularly if speeds are high. However, in the intersection environment, drivers will generally expect to travel at slower speeds and will accept the higher side force caused by reasonable adverse superelevation (10).

Exhibit 6-37 provides a typical section across the circulatory roadway of a roundabout without a truck apron. Exhibit 6-38 provides a typical section for a roundabout with a truck apron. Where truck aprons are used, the slope of the apron should be 3 to 4 percent; greater slopes may increase the likelihood of loss-of-load incidents.

Exhibit 6-37. Typical circulatory roadway section.

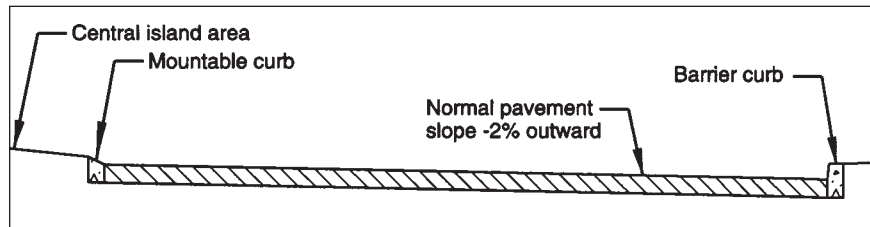
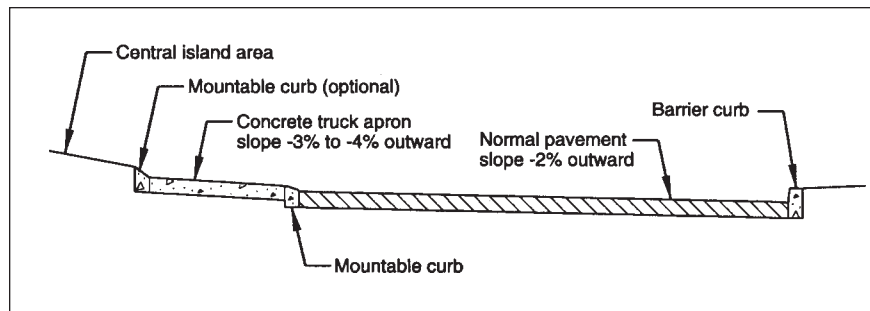

Exhibit 6-38. Typical section with a truck apron.



6.3.11.3 Locating roundabouts on grades

It is generally not desirable to locate roundabouts in locations where grades through the intersection are greater than four percent. The installation of roundabouts on roadways with grades lower than three percent is generally not problematic (6). At locations where a constant grade must be maintained through the intersection, the circulatory roadway may be constructed on a constant-slope plane. This means, for instance, that the cross slope may vary from +3 percent on the high side of the roundabout (sloped toward the central island) to -3 percent on the low side (sloped outward). Note that central island cross slopes will pass through level at a minimum of two locations for roundabouts constructed on a constant grade.

Care must be taken when designing roundabouts on steep grades. On approach roadways with grades steeper than -4 percent, it is more difficult for entering drivers to slow or stop on the approach. At roundabouts on crest vertical curves with steep approaches, a driver's sight lines will be compromised, and the roundabout may violate driver expectancy. However, under the same conditions, other types of at-grade intersections often will not provide better solutions. Therefore, the roundabout should not necessarily be eliminated from consideration at such a location. Rather, the intersection should be relocated or the vertical profile modified, if possible.

6.3.11.4 Drainage

With the circulatory roadway sloping away from the central island, inlets will generally be placed on the outer curbline of the roundabout. However, inlets may be required along the central island for a roundabout designed on a constant grade through an intersection. As with any intersection, care should be taken to ensure that low points and inlets are not placed in crosswalks. If the central island is large enough, the designer may consider placing inlets in the central island.

6.3.12 Bicycle provisions

With regard to bicycle treatments, the designer should strive to provide bicyclists the choice of proceeding through the roundabout as either a vehicle or a pedestrian. In general, bicyclists are better served by treating them as vehicles. However, the best design provides both options to allow cyclists of varying degrees of skill to choose their more comfortable method of navigating the roundabout.

To accommodate bicyclists traveling as vehicles, bike lanes should be terminated in advance of the roundabout to encourage cyclists to mix with vehicle traffic. Under this treatment, it is recommended that bike lanes end 30 m (100 ft) upstream of the yield line to allow for merging with vehicles (11). This method is most successful at smaller roundabouts with speeds below 30 km/h (20 mph), where bicycle speeds can more closely match vehicle speeds.

To accommodate bicyclists who prefer not to use the circulatory roadway, a widened sidewalk or a shared bicycle/pedestrian path may be provided physically separated from the circulatory roadway (not as a bike lane within the circulatory

Avoid locating roundabouts in areas where grades through the intersection are greater than 4%.

Terminate bicycle lanes prior to a roundabout.

Ramps leading to a shared pathway can be used to accommodate bicyclists traveling as pedestrians.

roadway). Ramps or other suitable connections can then be provided between this sidewalk or path and the bike lanes, shoulders, or road surface on the approaching and departing roadways. The designer should exercise care in locating and designing the bicycle ramps so that they are not misconstrued by pedestrians as an unmarked pedestrian crossing. Nor should the exits from the roadway onto a shared path allow cyclists to enter the shared path at excessive speeds. Exhibit 6-39 illustrates a possible design of this treatment. The reader is encouraged to refer to the *AASHTO Guide for Development of Bicycle Facilities* (12) for a more detailed discussion of the design requirements for bicycle and shared-use path design.

Exhibit 6-39. Possible provisions for bicycles.

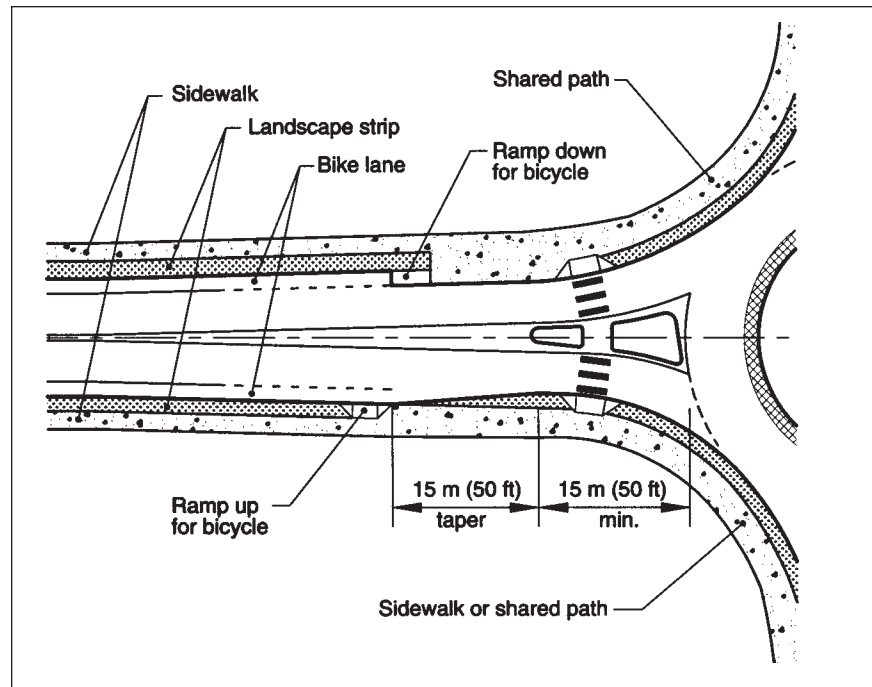

6.3.13 Sidewalk treatments

Set back sidewalks 1.5 m (5 ft) from the circulatory roadway where possible.

Where possible, sidewalks should be set back from the edge of the circulatory roadway in order to discourage pedestrians from crossing to the central island, particularly when an apron is present or a monument on the central island. Equally important, the design should help pedestrians with visual impairments to recognize that they should not attempt to cross streets from corner to corner but at designated crossing points. To achieve these goals, the sidewalk should be designed so that pedestrians will be able to clearly find the intended path to the crosswalks. A recommended set back distance of 1.5 m (5 ft) (minimum 0.6 m [2 ft]) should be used, and the area between the sidewalk and curb can be planted with low shrubs or grass (see Chapter 7). Exhibit 6-40 shows this technique.

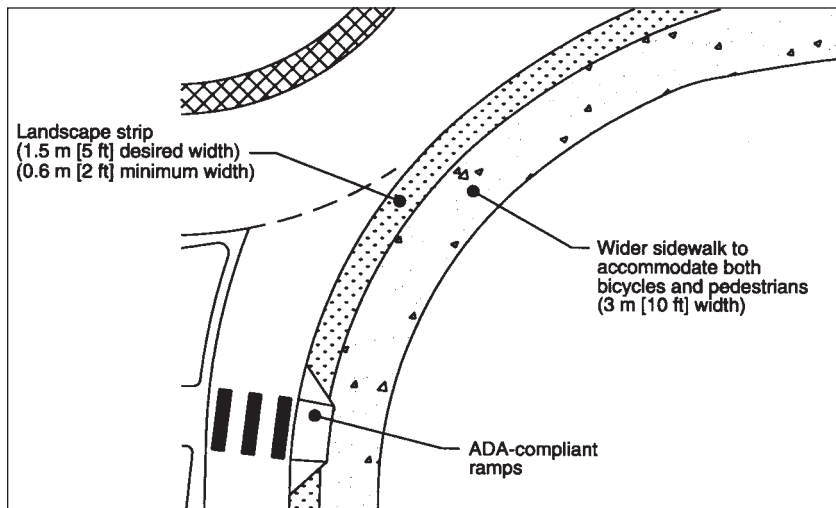

Exhibit 6-40. Sidewalk treatments.

6.3.14 Parking considerations and bus stop locations

Parking or stopping in the circulatory roadway is not conducive to proper roundabout operations and should be prohibited. Parking on entries and exits should also be set back as far as possible so as not to hinder roundabout operations or to impair the visibility of pedestrians. AASHTO recommends that parking should end at least 6.1 m (20 ft) from the crosswalk of an intersection (4). Curb extensions or “bulb-outs” can be used to clearly mark the limit of permitted parking and reduce the width of the entries and exits.

For safety and operational reasons, bus stops should be located as far away from entries and exits as possible, and never in the circulatory roadway.

- *Near-side stops:* If a bus stop is to be provided on the near side of a roundabout, it should be located far enough away from the splitter island so that a vehicle overtaking a stationary bus is in no danger of being forced into the splitter island, especially if the bus starts to pull away from the stop. If an approach has only one lane and capacity is not an issue on that entry, the bus stop could be located at the pedestrian crossing in the lane of traffic. This is not recommended for entries with more than one lane, because vehicles in the lane next to the bus may not see pedestrians.
- *Far-side stops:* Bus stops on the far side of a roundabout should be constructed with pull-outs to minimize queuing into the roundabout. These stops should be located beyond the pedestrian crossing to improve visibility of pedestrians to other exiting vehicles.

Right-turn bypass lanes can be used in locations with minimal pedestrian and bicycle activity to improve capacity when heavy right-turning traffic exists.

6.3.15 Right-turn bypass lanes

In general, right-turn bypass lanes (or *right-turn slip lanes*) should be avoided, especially in urban areas with bicycle and pedestrian activity. The entries and exits of bypass lanes can increase conflicts with bicyclists. The generally higher speeds of bypass lanes and the lower expectation of drivers to stop increases the risk of collisions with pedestrians. However, in locations with minimal pedestrian and bicycle activity, right-turn bypass lanes can be used to improve capacity where there is heavy right turning traffic.

The provision of a right-turn bypass lane allows right-turning traffic to bypass the roundabout, providing additional capacity for the through and left-turn movements at the approach. They are most beneficial when the demand of an approach exceeds its capacity and a significant proportion of the traffic is turning right. However, it is important to consider the reversal of traffic patterns during the opposite peak time period. In some cases, the use of a right-turn bypass lane can avoid the need to build an additional entry lane and thus a larger roundabout. To determine if a right-turn bypass lane should be used, the capacity and delay calculations in Chapter 4 should be performed. Right-turn bypass lanes can also be used in locations where the geometry for right turns is too tight to allow trucks to turn within the roundabout.

Exhibit 6-41 shows an example of a right-turn bypass lane.

Exhibit 6-41. Example of right-turn bypass lane.



There are two design options for right-turn bypass lanes. The first option, shown in Exhibit 6-42, is to carry the bypass lane parallel to the adjacent exit roadway, and then merge it into the main exit lane. Under this option, the bypass lane should be carried alongside the main roadway for a sufficient distance to allow vehicles in the bypass lane and vehicles exiting the roundabout to accelerate to comparable speeds. The bypass lane is then merged at a taper rate according to AASHTO guidelines for the appropriate design speed. The second design option for a right-turn bypass lane, shown in Exhibit 6-43, is to provide a yield-controlled entrance onto the adjacent exit roadway. The first option provides better operational performance than the second does. However, the second option generally requires less construction and right-of-way than the first.

Right-turn bypass lanes can merge back into the main exit roadway or provide a yield-controlled entrance onto the main exit roadway.

The option of providing yield control on a bypass lane is generally better for both bicyclists and pedestrians and is recommended as the preferred option in urban areas where pedestrians and bicyclists are prevalent. Acceleration lanes can be problematic for bicyclists because they end up being to the left of accelerating motor vehicles. In addition, yield control at the end of a bypass lane tends to slow motorists down, whereas an acceleration lane at the end of a bypass lane tends to promote higher speeds.

The radius of the right-turn bypass lane should not be significantly larger than the radius of the fastest entry path provided at the roundabout. This will ensure vehicle speeds on the bypass lane are similar to speeds through the roundabout, resulting in safe merging of the two roadways. Providing a small radius also provides greater safety for pedestrians who must cross the right-turn slip lane.

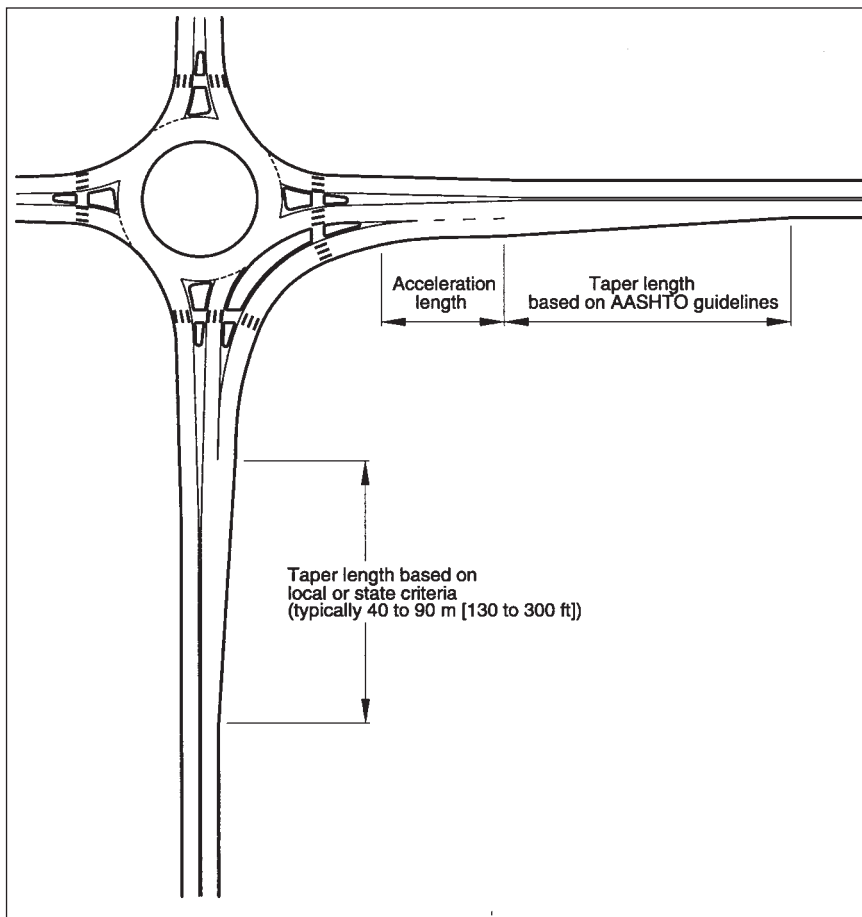
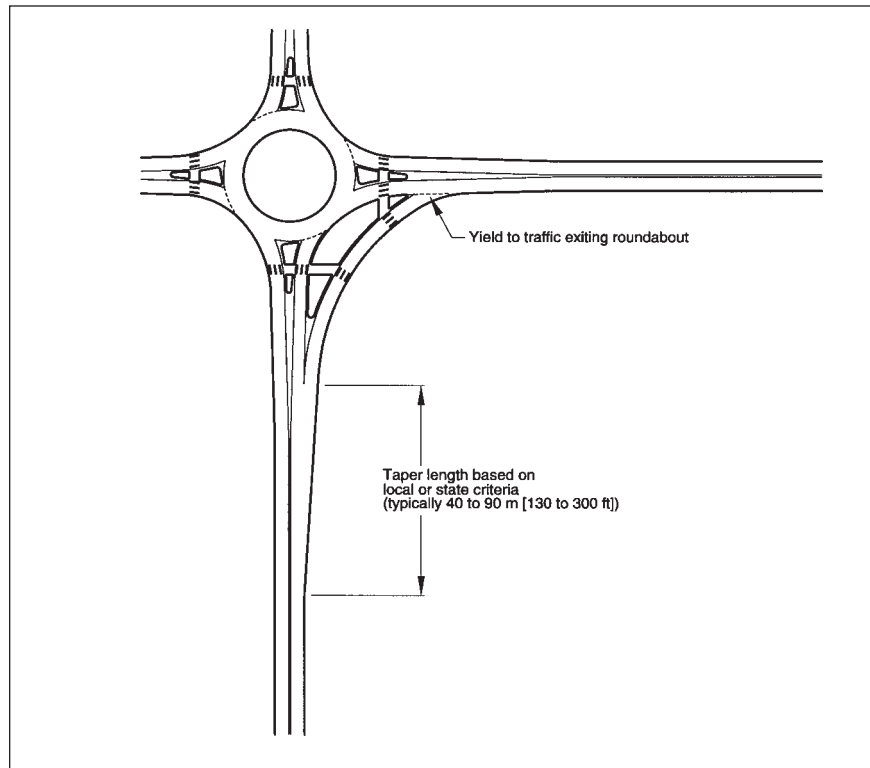

Exhibit 6-42. Configuration of right-turn bypass lane with acceleration lane.

Exhibit 6-43. Configuration of right-turn bypass with yield at exit leg.



6.4 Double-Lane Roundabouts

While the fundamental principles described above apply to double-lane roundabouts as well as single-lane roundabouts, designing the geometry of double-lane roundabouts is more complicated. Because multiple traffic streams may enter, circulate through, and exit the roundabout side-by-side, consideration must be given to how these adjacent traffic streams interact with each other. Vehicles in adjacent entry lanes must be able to negotiate the roundabout geometry without competing for the same space. Otherwise, operational and/or safety deficiencies can occur.

6.4.1 The natural vehicle path

As discussed in Section 6.2.1, the fastest path through the roundabout is drawn to ensure the geometry imposes sufficient curvature to achieve a safe design speed. This path is drawn assuming the roundabout is vacant of all other traffic and the vehicle cuts across adjacent travel lanes, ignoring all lane markings. In addition to evaluating the fastest path, at double-lane roundabouts the designer must also evaluate the *natural* vehicle paths. This is the path an approaching vehicle will naturally take, assuming there is traffic in all approach lanes, through the roundabout geometry.

As two traffic streams approach the roundabout in adjacent lanes, they will be forced to stay in their lanes up to the yield line. At the yield point, vehicles will continue along their natural trajectory into the circulatory roadway, then curve around the central island, and curve again into the opposite exit roadway. The speed and orientation of the vehicle at the yield line determines its natural path. If the natural path of one lane interferes or overlaps with the natural path of the adjacent lane, the roundabout will not operate as safely or efficiently as possible.

The key principle in drawing the natural path is to remember that drivers cannot change the direction of their vehicle instantaneously. Neither can they change their speed instantaneously. This means that the natural path does not have sudden changes in curvature; it has transitions between tangents and curves and between consecutive reversing curves. Secondly, it means that consecutive curves should be of similar radius. If a second curve has a significantly smaller radius than the first curve, the driver will be traveling too fast to negotiate the turn and may lose control of the vehicle. If the radius of one curve is drawn significantly smaller than the radius of the previous curve, the path should be adjusted.

To identify the natural path of a given design, it may be advisable to sketch the natural paths over the geometric layout, rather than use a computer drafting program or manual drafting equipment. In sketching the path, the designer will naturally draw transitions between consecutive curves and tangents, similar to the way a driver would negotiate an automobile. Freehand sketching also enables the designer to feel how changes in one curve affect the radius and orientation of the next curve. In general, the sketch technique allows the designer to quickly obtain a smooth, natural path through the geometry that may be more difficult to obtain using a computer.

Exhibit 6-44 illustrates a sketched natural path of a vehicle through a typical double-lane roundabout.

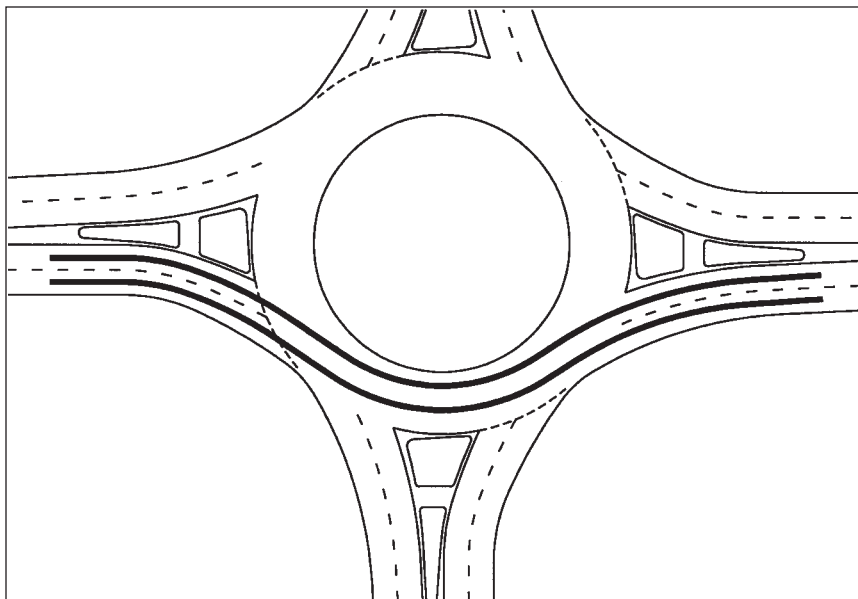
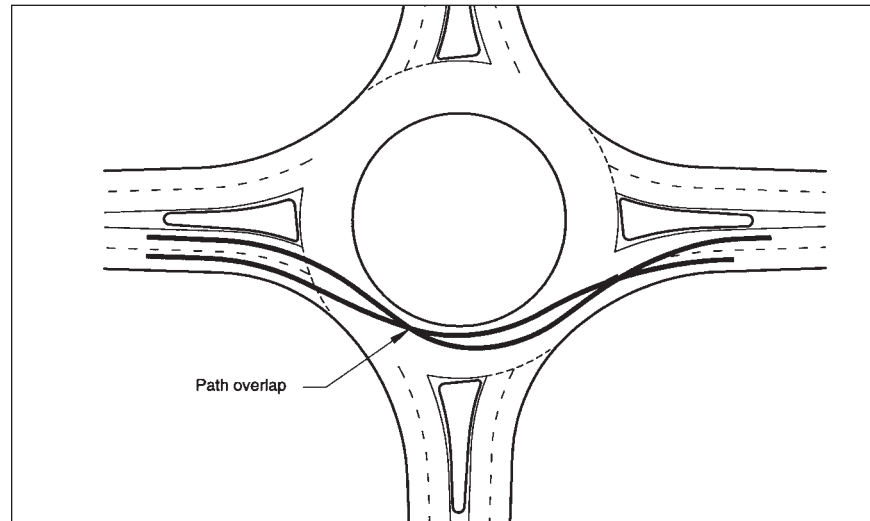

Exhibit 6-44. Sketched natural paths through a double-lane roundabout.

6.4.2 Vehicle path overlap

Vehicle path overlap occurs when the natural path through the roundabout of one traffic stream overlaps the path of another. This can happen to varying degrees. It can reduce capacity, as vehicles will avoid using one or more of the entry lanes. It can also create safety problems, as the potential for sideswipe and single-vehicle crashes is increased. The most common type of path overlap is where vehicles in the left lane on entry are cut off by vehicles in the right lane, as shown in Exhibit 6-45.

Exhibit 6-45. Path overlap at a double-lane roundabout.



6.4.3 Design method to avoid path overlap

Achieving a reasonably low design speed at a double-lane roundabout while avoiding vehicle path overlap can be difficult because of conflicting interaction between the various geometric parameters. Providing small entry radii can produce low entry speeds, but often leads to path overlap on the entry, as vehicles will cut across lanes to avoid running into the central island. Likewise, providing small exit radii can aid in keeping circulating speeds low, but may result in path overlap at the exits.

6.4.3.1 Entry curves

At double-lane entries, the designer needs to balance the need to control entry speed with the need to minimize path overlap. This can be done a variety of ways that will vary significantly depending on site-specific conditions, and it is thus inappropriate to specify a single method for designing double-lane roundabouts. Regardless of the specific design method employed, the designer should maintain the overall design principles of speed control and speed consistency presented in Section 6.2.

One method to avoid path overlap on entry is to start with an inner entry curve that is curvilinearly tangential to the central island and then draw parallel alignments to determine the position of the outside edge of each entry lane. These curves can range from 30 to 60 m (100 to 200 ft) in urban environments and 40 to 80 m (130 to 260 ft) in rural environments. These curves should extend approximately 30 m (100

ft) to provide clear indication of the curvature to the driver. The designer should check the critical vehicle paths to ensure that speeds are sufficiently low and consistent between vehicle streams. The designer should also ensure that the portion of the splitter island in front of the crosswalk meets AASHTO recommendations for minimum size. Exhibit 6-46 demonstrates this method of design.

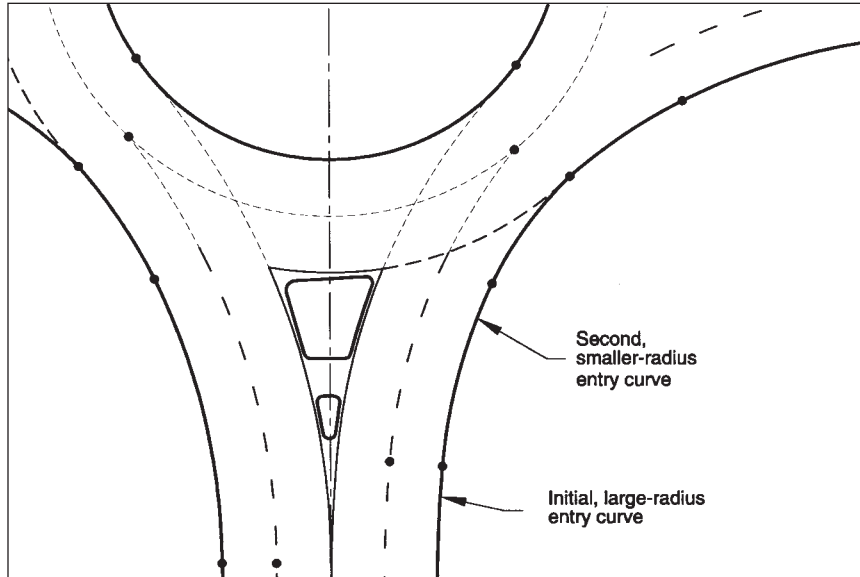

Exhibit 6-46. One method of entry design to avoid path overlap at double-lane roundabouts.

Another method to reduce entry speeds and avoid path overlap is to use a small-radius (generally 15 to 30 m [50 to 100 ft]) curve approximately 10 to 15 m (30 to 50 ft) upstream of the yield line. A second, larger-radius curve (or even a tangent) is then fitted between the first curve and the edge of the circulatory roadway. In this way, vehicles will still be slowed by the small-radius approach curve, and they will be directed along a path that is tangential to the central island at the time they reach the yield line. Exhibit 6-47 demonstrates this alternate method of design.

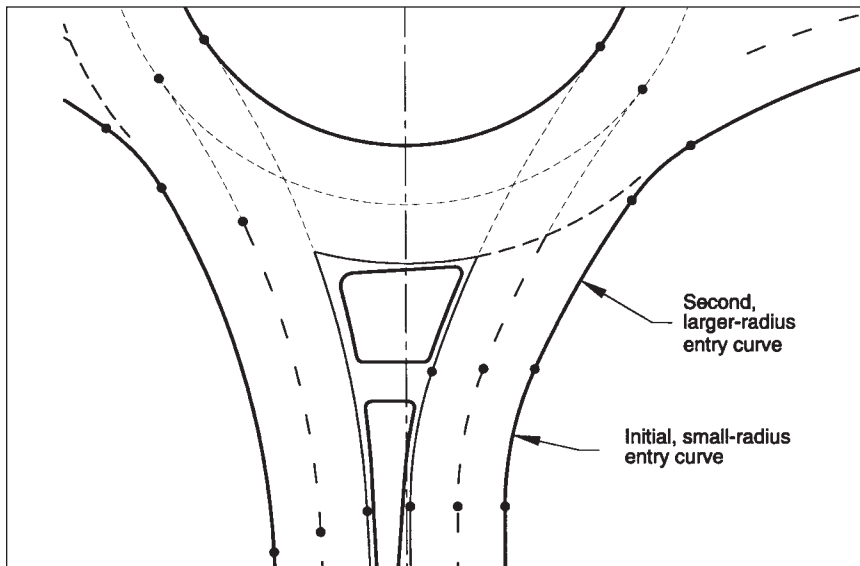

Exhibit 6-47. Alternate method of entry design to avoid path overlap at double-lane roundabouts.

As in the case of single-lane roundabouts, it is a primary objective to ensure that the entry path radius along the fastest path is not substantially larger than the circulating path radius. Referring to Exhibit 6-12, it is desirable for R_1 to be less than or approximately equal to R_2 . At double-lane roundabouts, however, R_1 should not be excessively small. If R_1 is too small, vehicle path overlap may result, reducing the operational efficiency and increasing potential for crashes. Values for R_1 in the range of 40 to 70 m (130 to 230 ft) are generally preferable. This results in a design speed of 35 to 45 km/h (22 to 28 mph).

The entry path radius, R_1 , is controlled by the offset between the right curb line on the entry roadway and the curb line of the central island (on the driver's left). If the initial layout produces an entry path radius above the preferred design speed, one way to reduce it is to gradually shift the approach to the left to increase the offset; however, this may increase adjacent exit speeds. Another method to reduce the entry path radius is to move the initial, small-radius entry curve closer to the circulatory roadway. This will decrease the length of the second, larger-radius curve and increase the deflection for entering traffic. However, care must be taken to ensure this adjustment does not produce overlapping natural paths.

6.4.3.2 Exit curves

To avoid path overlap on the exit, it is important that the exit radius at a double-lane roundabout not be too small. At single-lane roundabouts, it is acceptable to use a minimal exit radius in order to control exit speeds and maximize pedestrian safety. However, the same is not necessarily true at double-lane roundabouts. If the exit radius is too small, traffic on the inside of the circulatory roadway will tend to exit into the outside exit lane on a more comfortable turning radius.

At double-lane roundabouts in urban environments, the principle for maximizing pedestrian safety is to reduce vehicle speeds prior to the yield and maintain similar (or slightly lower) speeds within the circulatory roadway. At the exit points, traffic will still be traveling slowly, as there is insufficient distance to accelerate significantly. If the entry and circulating path radii (R_1 and R_2 , as shown on Exhibit 6-12) are each 50 m (165 ft), exit speeds will generally be below 40 km/h (25 mph) regardless of the exit radius.

To achieve exit speeds slower than 40 km/h (25 mph), as is often desirable in environments with significant pedestrian activity, it may be necessary to tighten the exit radius. This may improve safety for pedestrians at the possible expense of increased vehicle-vehicle collisions.

6.5 Rural Roundabouts

Roundabouts located on rural roads often have special design considerations because approach speeds are higher than urban or local streets and drivers generally do not expect to encounter speed interruptions. The primary safety concern in rural locations is to make drivers aware of the roundabout with ample distance to comfortably decelerate to the appropriate speed. This section provides design guidelines for providing additional speed-reduction measures on rural roundabout approaches.

6.5.1 Visibility

Perhaps the most important element affecting safety at rural intersections is the visibility of the intersection itself. Roundabouts are no different from stop-controlled or signalized intersections in this respect except for the presence of curbing along roadways that are typically not curbed. Therefore, although the number and severity of multiple-vehicle collisions at roundabouts may decrease (as discussed previously), the number of single-vehicle crashes may increase. This potential can be minimized with attention to proper visibility of the roundabout and its approaches.

Roundabout visibility is a key design element at rural locations.

Where possible, the geometric alignment of approach roadways should be constructed to maximize the visibility of the central island and the general shape of the roundabout. Where adequate visibility cannot be provided solely through geometric alignment, additional treatments (signing, pavement markings, advanced warning beacons, etc.) should be considered (see Chapter 7). Note that many of these treatments are similar to those that would be applied to rural stop-controlled or signalized intersections.

6.5.2 Curbing

On an open rural highway, changes in the roadway's cross-section can be an effective means to help approaching drivers recognize the need to reduce their speed. Rural highways typically have no outside curbs with wide paved or gravel shoulders. Narrow shoulder widths and curbs on the outside edges of pavement, on the other hand, generally give drivers a sense they are entering a more urbanized setting, causing them to naturally slow down. Thus, consideration should be given to reducing shoulder widths and introducing curbs when installing a roundabout on an open rural highway.

Curbs should be provided at all rural roundabouts.

Curbs help to improve delineation and to prevent "corner cutting," which helps to ensure low speeds. In this way, curbs help to confine vehicles to the intended design path. The designer should carefully consider all likely design vehicles, including farm equipment, when setting curb locations. Little research has been performed to date regarding the length of curbing required in advance of a rural roundabout. In general, it may be desirable to extend the curbing from the approach for at least the length of the required deceleration distance to the roundabout.

6.5.3 Splitter islands

Another effective cross-section treatment to reduce approach speeds is to use longer splitter islands on the approaches (10). Splitter islands should generally be extended upstream of the yield bar to the point at which entering drivers are expected to begin decelerating comfortably. A minimum length of 60 m (200 ft) is recommended (10). Exhibit 6-48 provides a diagram of such a splitter island design. The length of the splitter island may differ depending upon the approach speed. The AASHTO recommendations for required braking distance with an alert driver should be applied to determine the ideal splitter island length for rural roundabout approaches.

Extended splitter islands are recommended at rural locations.

A further speed-reduction technique is the use of landscaping on the extended splitter island and roadside to create a "tunnel" effect. If such a technique is used, the stopping and intersection sight distance requirements (sections 6.3.9 and 6.3.10) will dictate the maximum extent of such landscaping.

Exhibit 6-48. Extended splitter island treatment.

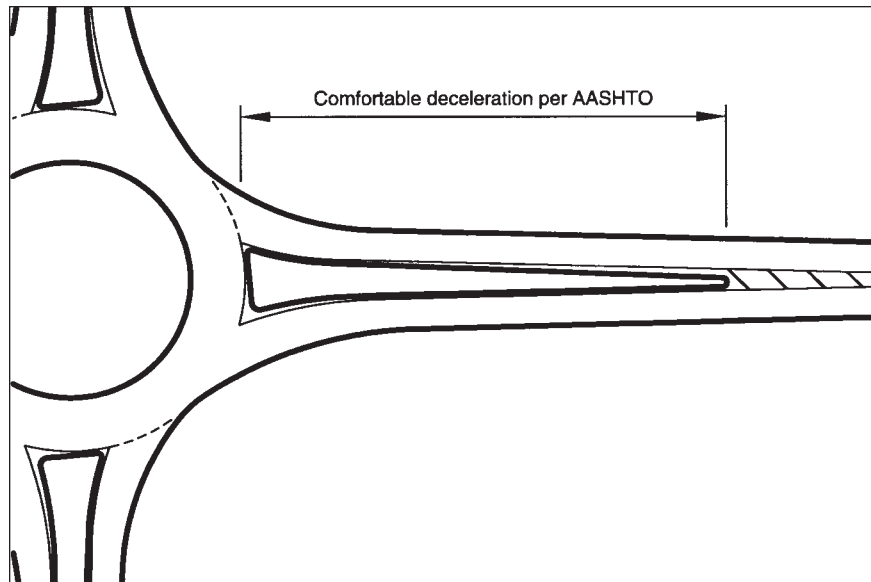

6.5.4 Approach curves

Roundabouts on high-speed roads (speeds of 80 km/h [50 mph] or higher), despite extra signing efforts, may not be expected by approaching drivers, resulting in erratic behavior and an increase in single-vehicle crashes. Good design encourages drivers to slow down before reaching the roundabout, and this can be most effectively achieved through a combination of geometric design and other design treatments (see Chapter 7). Where approach speeds are high, speed consistency on the approach needs to be addressed to avoid forcing all of the reduction in speed to be completed through the curvature at the roundabout.

The radius of an approach curve (and subsequent vehicular speeds) has a direct impact on the frequency of crashes at a roundabout. A study in Queensland, Australia, has shown that decreasing the radius of an approach curve generally decreases the approaching rear-end vehicle crash rate and the entering-circulating and exiting-circulating vehicle crash rates (see Chapter 5). On the other hand, decreasing the radius of an approach curve may increase the single-vehicle crash rate on the curve, particularly when the required side-friction for the vehicle to maintain its path is too high. This may encourage drivers to cut across lanes and increase sideswipe crash rates on the approach curve (2).

One method to achieve speed reduction that reduces crashes at the roundabout while minimizing single-vehicle crashes is the use of successive curves on approaches. The study in Queensland, Australia, found that by limiting the change in 85th-percentile speed on successive geometric elements to 20 km/h (12 mph), the crash rate was reduced. It was found that the use of successive reverse curves prior to the roundabout approach curve reduced the single-vehicle crash rate and the sideswipe crash rate on the approach. It is recommended that approach speeds immediately prior to the entry curves of the roundabout be limited to 60 km/h (37 mph) to minimize high-speed rear-end and entering-circulating vehicle crashes.

Exhibit 6-49 shows a typical rural roundabout design with a succession of three curves prior to the yield line. As shown in the exhibit, these approach curves should be successively smaller radii in order to minimize the reduction in design speed between successive curves. The aforementioned Queensland study found that shifting the approaching roadway laterally by 7 m (23 ft) usually enables adequate curvature to be obtained while keeping the curve lengths to a minimum. If the lateral shift is too small, drivers are more likely to cut into the adjacent lane (2).

A series of progressively sharper curves on a high-speed roundabout approach helps slow traffic to an appropriate entry speed.

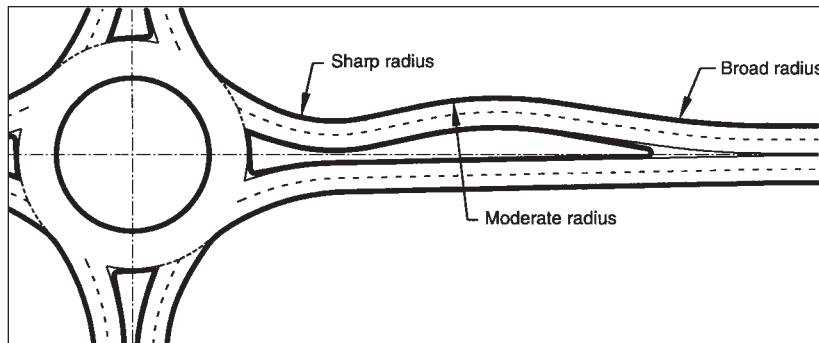

Exhibit 6-49. Use of successive curves on high speed approaches.

Equations 6-4 and 6-5 can be used to estimate the operating speed of two-lane rural roads as a function of degree of curvature. Equation 6-6 can be used similarly for four-lane rural roads (13).

Two-lane rural roads:

$$V_{85} = 103.66 - 1.95D, D \geq 3^\circ \quad (6-4)$$

$$V_{85} = 97.9, D < 3^\circ \quad (6-5)$$

where: V_{85} = 85th-percentile speed, km/h (1 km/h = 0.621 mph); and
 D = degree of curvature, degrees = $1746.38 / R$
 R = radius of curve, m

Four-lane rural roads:

$$V_{85} = 103.66 - 1.95D \quad (6-6)$$

where: V_{85} = 85th-percentile speed, km/h (1 km/h = 0.621 mph); and
 D = degree of curvature, degrees = $1746.38 / R$
 R = radius of curve, m

6.6 Mini-Roundabouts

As discussed in Chapter 1, a mini-roundabout is an intersection design alternative that can be used in place of stop control or signalization at physically constrained intersections to help improve safety problems and excessive delays at minor approaches. Mini-roundabouts are not traffic calming devices but rather are a form of roundabout intersection. Exhibit 6-50 presents an example of a mini-roundabout.

Mini-roundabouts are not recommended where approach speeds are greater than 50 km/h (30 mph), nor in locations with high U-turning volumes.

Exhibit 6-50. Example of a mini-roundabout.

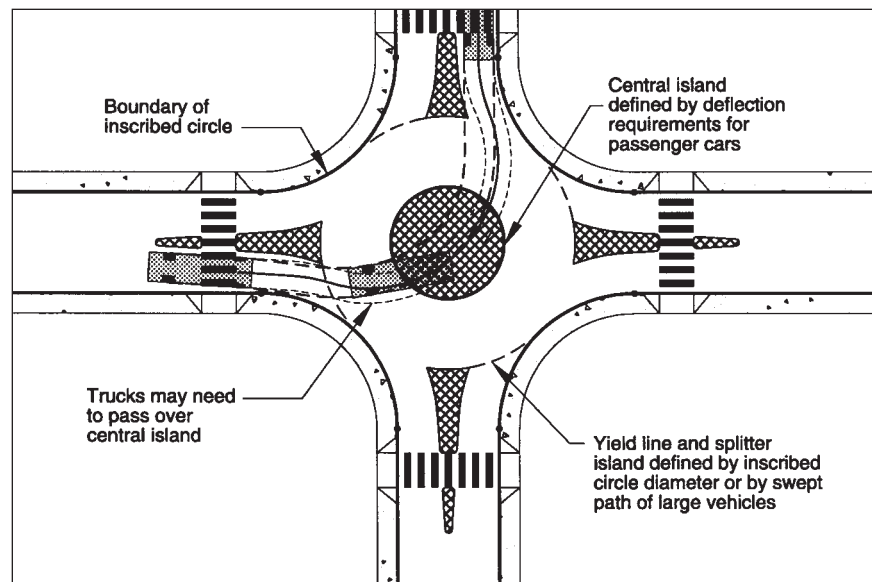

Mini-roundabouts should only be considered in areas where all approaching roadways have an 85th-percentile speed of less than 50 km/h (30 mph). In addition, mini-roundabouts are not recommended in locations in which high U-turn traffic is expected, such as at the ends of street segments with access restrictions. Mini-roundabouts are not well suited for high volumes of trucks, as trucks will occupy most of the intersection when turning.

The central island of a mini-roundabout should be clear and conspicuous.

The design of the central island of a mini-roundabout is defined primarily by the requirement to achieve speed reduction for passenger cars. As discussed previously in Section 6.2, speed reduction for entering vehicles and speed consistency with circulating vehicles are important. Therefore, the location and size of the central island are dictated by the inside of the swept paths of passenger cars that is needed to achieve a maximum recommended entry speed of 25 km/h (15 mph). The central island of a mini-roundabout is typically a minimum of 4 m (13 ft) in diameter and is fully mountable by large trucks and buses. Composed of asphalt, concrete, or other paving material, the central island should be domed at a height of 25 to 30 mm per 1 m diameter (0.3 to 0.36 in per 1 ft diameter), with a maximum height of 125 mm (5 in) (14). Although fully mountable and relatively small, it is essential that the central island be clear and conspicuous (14, 15). Chapter 7 provides a sample signing and striping planing plan for mini-roundabout.

The outer swept path of passenger cars and large vehicles is typically used to define the location of the yield line and boundary of each splitter island with the circulatory roadway. Given the small size of a mini-roundabout, the outer swept path of large vehicles may not be coincident with the inscribed circle of the roundabout, which is defined by the outer curbs. Therefore, the splitter islands and yield line may extend into the inscribed circle for some approach geometries. On the other hand, for very small mini-roundabouts, such as the one shown in Exhibit 6-50, all turning trucks will pass directly over the central island while not encroaching on the circulating roadway to the left which may have opposing traffic. In these cases, the yield line and splitter island should be set coincident with the inscribed

6.7 References

1. Department of Transport of Northrhine-Westfalia, Germany. *Empfehlungen zum Einsatz und zur Gestaltung von Mini-Kreisverkehrsplaetzen (Guidelines for the Use and Design of Mini-Roundabouts)*. Dusseldorf, Germany, 1999.
2. Queensland Department of Main Roads (QDMR). *Relationships between Roundabout Geometry and Accident Rates*. Queensland, Australia: Infrastructure Design of the Technology Division of QDMR, April 1998.
3. Department of Transport (United Kingdom). *Geometric Design of Roundabouts*. TD 16/93. September 1993.
4. American Association of State Highway and Transportation Officials (AASHTO). *A Policy on Geometric Design of Highways and Streets*. Washington, D.C.: AASHTO, 1994.
5. Pein, W.E. *Trail Intersection Design Guidelines*. Prepared for State Bicycle/Pedestrian Program, State Safety Office, Florida Department of Transportation. Highway Safety Research Center, University of North Carolina, September 1996.
6. Service d'Etudes Techniques des Routes et Autoroutes (SETRA—Center for Technical Studies of Roads and Highways). *Aménagement des Carrefours Interurbains sur les Routes Principales (Design of Rural Intersections on Major Roads)*. Ministry of Transport and Housing, December 1998.
7. *Americans with Disabilities Act Accessibility Guidelines for Buildings and Facilities (ADAAG)*. 36 CFR Part 1191. As amended through January 1998.
8. Fambro, D.B., et al. *NCHRP Report 400: Determination of Stopping Sight Distances*. National Cooperative Highway Research Program, Transportation Research Board, National Research Council. Washington, D.C.: National Academy Press, 1997.
9. Harwood, D.W., et al. *NCHRP Report 383: Intersection Sight Distances*. National Cooperative Highway Research Program, Transportation Research Board, National Research Council. Washington, D.C.: National Academy Press, 1996.
10. Austroads. *Guide to Traffic Engineering Practice, Part 6—Roundabouts*. Sydney, Australia: Austroads, 1993.
11. Florida Department of Transportation. *Florida Roundabout Guide*. Florida Department of Transportation, March 1996.
12. American Association of State Highway and Transportation Officials (AASHTO). *Guide for Development of Bicycle Facilities*. Washington, D.C.: AASHTO, 1991.
13. Krammes, R., et al. *Horizontal Alignment Design Consistency for Rural Two-Lane Highways*. Publication No. FHWA-RD-94-034. Washington, D.C.: Federal Highway Administration, January 1995.
14. Sawers, C. *Mini-roundabouts: Getting them right!*. Canterbury, Kent, United Kingdom: Euro-Marketing Communications, 1996.
15. Brilon, W., and L. Bondzio. *Untersuchung von Mini-Kreisverkehrsplaetzen (Investigation of Mini-Roundabouts)*. Ruhr-University Bochum, Germany, 1999.