



*An Online PDH Course
brought to you by
CEDengineering.com*

Building Elevator Systems

Course No: A06-001

Credit: 6 PDH

A. Bhatia



Continuing Education and Development, Inc.

P: (877) 322-5800

info@cedengineering.com

BUILDING ELEVATOR SYSTEMS

For most people residing in urban cities, elevators have become an integral part of their daily life. Simply stated, an elevator is a hoisting or lowering mechanism, designed to carry passengers or freight, and is equipped with a car and platform that typically moves in fixed guides and serves two or more landings. The elevators can be broadly classified as either electric traction type or hydraulic type.

- Traction elevators have an elevator car and counterweight attached to opposite ends of hoist ropes. The hoist ropes pass over a driving machine that raises and lowers the car. Traction elevators run on load-bearing rails in the elevator hoistway. Traction elevators are most often used in mid-rise and high-rise buildings with five or more floors.
- Hydraulic elevators, on the other hand, are raised by forcing pressurized oil through a valve into a steel cylinder located above ground or underground. The pressure forces a piston to rise, lifting the elevator platform and car enclosure mounted on it. The car is lowered by opening the valve and allowing the weight of the car to force oil from the cylinder in a controlled manner. When the valve is closed the car is stopped. Since the weight of hydraulic elevator cars is borne by the piston, there is no need for a structural framework or load-bearing rails. Hydraulic elevators are commonly found in low-rise buildings with two to five floors.

The main design considerations for choosing either electric traction drive or hydraulic for a particular project are the number of floors, the height of the building, the number of people to be transported, desired passenger waiting times and frequency of use.

The other mode of vertical building transportation is “Escalator”. It can be described as moving stairs typically used to carry large number of people at high volumes through a limited no of floors. These are commonly used in high density areas or where sudden traffic surges are expected at times; for example at discharge times from offices, railways underground stations, airport terminals, theaters, shopping malls and departmental stores. In such applications, escalators will provide shorter travel time than elevators because elevator cars are limited in size and passengers have to wait longer for the service.

In this course we will discuss the key notions pertaining to elevator systems.

SECTION - 1 GENERAL ELEVATOR PLANNING

Several factors combine to influence the cost of an elevator installation, including the passenger handling capacity, waiting interval, speed, location, finishes, intelligent group control safety, and reliability. There are also risks associated with the use of elevators. To ensure that persons are not stuck in elevators for longer periods of time, or worse that the elevator does not lose stability and plummet to the basement from a high floor, the engineers responsible for designing elevators must comply with all statutory codes and standards.

Typical parameters in design of elevators include:

Characteristic of the premises

- Type and use of building;
- Floor plate size and height of the building;
- Size of population and its distribution in the premises;
- Fire safety and regulations;
- The house keeping of the premises.

Circulation Efficiency

- Number of cars and their capacity;
- Location and configuration of elevators in entrance lobby;
- Travel length, number of stops and maximum acceptable waiting time;
- Arrangement with the combination of elevator, escalator and emergency stairs.

Characteristic of the equipment

- Type of transportation systems;
- Rated load and car dimensions;
- The speed of the lift/escalator system;

- The type of motor drive control system of the machine;
- Mode of group supervisory control and safety features;
- Cab enclosure and hoist way door finishes;
- Emergency power supplies and fire protection systems;
- Requirements of the local regulations on vertical transport system.

And so on. There could be over a hundred different possible configurations for your building's elevators, and each will have its advantages and disadvantages compared with the others.

DEVELOPMENT PROCESS

The design, installation, and use of an elevator system is dictated according to various standards (aka elevator codes), which may typically be international, national, state, regional or city based. Building codes, fire regulations, the American Disabilities Act (ADA) and other Uniform Federal Accessibility Standards (UFAS) are a few examples of these rules to which the engineers and architects must submit. As far as the specific rules governing the design of elevators; American Society of Mechanical Engineer's Standard A17.1 (ASME/ANSI A17.1), CAN/CSA B44 in Canada and EN81 (European standard) provide the detailed criteria.

Note that in most US Jurisdictions, ASME/ANSI A17.1, A17.2, A17.3, A17.5, A18.1 usually take precedence over all other codes unless specifically advised.

DESIGN ELEMENTS OF ELEVATOR SYSTEMS

Traffic Planning

Elevators' planning in building projects is dependant on the "traffic analysis" study which varies according to the type and usage of the building. For example, an office building typically requires more elevators than an apartment building due to heavier loads & traffic. Elevator professionals often use building type to assist in recommending solutions based on different types of building traffic.

Traffic analysis is the study of the population distribution and their predicted pattern of flow within the day. It helps in selecting:

- The correct number and type of transportation devices;
- The right sizes and speeds of the transportation devices;
- The proper control systems and features to optimize and synchronize traffic flow;
- The optimum layout for the transportation devices and correct positioning in the building and in relation to one another;
- Easy access to buildings and a smooth flow of people and goods.

The efficiency of an elevator system is defined in terms of the quantity of service (handling capacity) and quality of service (passenger waiting time).

Handling Capacity:

The handling capacity of elevator system is the total number of passengers that the system can transport within a certain period of time, (usually 5 minutes i.e. 300 seconds) during the peak traffic conditions (usually the morning up-peak*) with a specified average car loading (usually 80% of the rated capacity of the elevator). The handling capacity is usually expressed in percentage and is calculated as:

$$HC = 0.8 \times \frac{300 \times RC}{I \times P} = \frac{240 \times RC}{I \times P}$$

Where

- HC = Handling capacity (percent)
- RC = Rated capacity of the elevator (lbs)
- I = Interval (seconds)
- P = Number of passengers carried on a round trip [the number of passengers carried on a round trip is established by the designer for each project, and is typically obtained by dividing elevator capacity by 150 pounds per person].

Acceptable five-minute handling capacities during peak periods for general passenger elevator service can be taken as 10 to 16%. The criteria differs depending on the building type — residential apartments or offices. As a rough guide, the following is acceptable:

- Residential Apartments / buildings: 7 to 9%.
- Premises without specific distribution traffic, such as mixed-tenancy office buildings with different working hours: 12 to 16%.
- Premises with excessive distribution traffic, such as single tenancy office buildings with the same working hours: 16 to 25%.

*The up-peak mode is defined as elevator travel from lobby to upper floors. This is considered the worst case traffic scenario in elevator planning, typically in the morning as people arrive for work or at the conclusion of a lunch-time period. The reason for employing the up peak model for sizing the lift is because during up- peak period, the “handling capacity” of the lift system dominates the degree to which the traffic demand is fulfilled. It is also believed that systems that can cope with the up-peak period are also sufficient to handle other traffic conditions.

What is the main purpose of estimating handling capacity?

Since the building space particularly in downtown skyscrapers is precious, the architects desire to ensure the elevator size fit for the purpose. The purpose of the Handling Capacity requirement is to allow designer to experiment with different lift system configurations and to determine the optimum size, speed and number of elevators for a building based on its peak use periods. Note that the use of smaller lift car will reduce system’s handling capacity unless more lift cars are installed. The requirement of the handling capacity ensures that the capacity of the lift system is not being traded off for the interval figures.

If the handling capacity of a lift system is too small, there will be lot of people queuing for the lifts during up peak. Also, the lift cars will have to go more round trips in order to clear off the queue. Thus system with too small handling capacity will degrade the quality of service.

Interval:

Interval or waiting interval is the average time, in seconds, between successive lift car arrivals at the main terminal floor with cars loaded to any level. The interval represents the theoretical longest time between elevator dispatches from the main lobby.

The interval is directly related to passenger waiting times and inversely related to the number of elevators in a group and is calculated by the following equation:

$$I = \frac{T}{n}$$

Where

- I = Interval
- T = round trip time for one elevator
- n = number of elevators in the group (in lift bank)

An acceptable interval during peak periods for ordinary occupancies can be taken as **25 to 30** seconds. An interval of 30 seconds means that a car will be leaving the lobby every 30 seconds with a load of passengers.

For a fixed handling capacity, large interval means small number of lift cars and large lift car rated capacity. Lift system with small number of lift cars but large rated capacity will result in inefficient use of energy during off peak hour. Imagine how energy is wasted during off peak hours when there are frequent occasions of only a few people traveling in a large lift car.

Round Trip Time

It is the time in seconds for a single car trip around a building, from the time the car doors open at the main terminal, until the car doors reopen, when the car has returned to the main terminal after its trip around the building.

The round trip time is estimated by adding together such factors as acceleration and deceleration rates, full-speed running time, door opening time, door closing time, and passenger entrance and egress times, multiplied by the probable number of stops.

Average Waiting Time

Average waiting time is the average period of time, in seconds that an average passenger waits for a lift measured from the instant that the passenger registers a landing call (or arrives at a landing), until the instant the passenger can enter the lift. Typically this would be the sum of the waiting times of all the passengers divided by the total number of passengers. It needs to be clearly recognized that Interval is NOT EQUAL TO Average Waiting Time. Average waiting time can be realistically established only through a simulation.

Other Factors

Once the traffic analysis is done and the handling capacity determined, the next step is to select and specify the most appropriate type of elevator. The first question to answer here is "*what exactly do we expect the elevator to accomplish for us?*"

This can be broken down into several more specific questions:

- How much weight must it lift?
- How fast should it lift it?
- How many landings will be served?
- How many elevators shall be provided?
- How large does the cab need to be?
- Are automatic doors or gates required?
- What is the ideal location of elevator?

Next, we have to determine the building structure that will support the elevator:

- What size is the hoistway?
- What is the wall construction?
- How deep is the pit?
- How high is the overhead?
- What kind of power is available?
- Is a machine room available?
- Is an overhead machine space available?
- How many car openings are required to suit the floor plan?
- Is underground drilling a problem?

These answers will usually narrow the available choices down.

Elevator Capacity

The elevators capacity is derived from up-peak traffic analysis. The nominal capacity of the elevator and the rated maximum passenger capacity is than known from manufacturer's catalogues. Table below provides standard nominal capacities and passenger relationship:

Passenger Elevator Service Capacities

Nominal Capacity	Rated Max Passenger Capacity	Passengers Per Trip (Normal Peak)*
1140 kg (2500 lbs)	17	13
1360 kg (3000 lbs)	20	16
1600 kg (3500 lbs)	23	19
1800 kg (4000 lbs)	27	21
2250 kg (5000 lbs)	33	27
2730 kg (6000 lbs)	40	32
3180 kg (7000 lbs)	47	37
3640 kg (8000 lbs)	53	43

*Peak passengers per trip (normal peak = 80% of rated capacity).

The normal peak or number of passengers per trip is generally assumed as 80% of the rated capacity of the lift car. This does not mean cars are assumed to fill only to 80% each trip but that the average load is 80% of rated capacity. The reason for assuming this 80% is that the passenger transfer times are longer for a crowded lift car. For example, the last person usually takes a longer time to enter a fully loaded lift car. Studies indicate that an 80% filled up car has the best performance in terms of round trip times.

Elevator Car Foot Print Area

Table 207.1 of ASME/ANSI A17.1 Standard provides the net cab area as it relates to the capacity

TABLE 207.1 of ASME A17.1

Maximum* inside Net Platform Areas for the Various Rated Loads

Rated Load (lb)	Inside Net Platform Area (ft ²)	Rated Load (lb)	Inside Net Platform Area (ft ²)
500	7.0	4500	46.2
600	8.3	5000	50.0
700	9.6	6000	57.7
1000	13.25	7000	65.3
1200	15.6	8000	72.9
1500	18.9	9000	80.5
1800	22.1	10000	88.0
2000	24.2	12000	103.0
2500	29.1	15000	125.1
3000	33.7	18000	146.9
3500	38.0	20000	161.2
4000	42.2	25000	196.5

This table can be used to develop the inside dimensions of car enclosures. Note - To allow for variations in cab designs, an increase in the maximum inside net platform area are not exceeding 5% shall be permitted for the various rated loads.

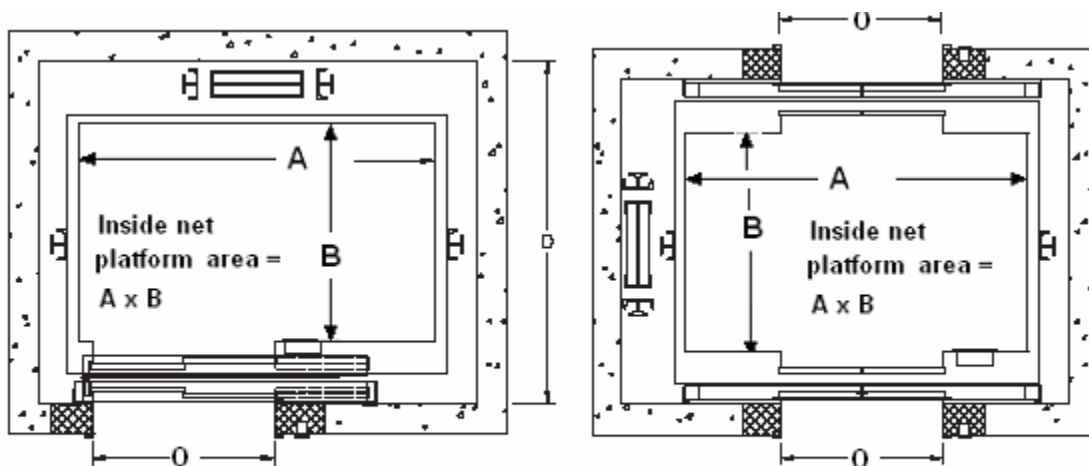

INSIDE NET PLATFORM AREAS FOR PASSENGER ELEVATORS

Number of Elevators

Several numbers of passenger elevators are usually required in most buildings in order to cope with the traffic density. The number of elevators is derived from a traditional traffic calculation during morning up peak. In this scenario, an elevator loads at the lobby, delivers passengers to their floors, and returns empty for the next trip. The number of elevators required shall be selected on the basis of a 25 to 30 second response waiting time interval between elevators.

The general rules of thumb for estimating the number of elevators are:

- For buildings with 3 or less elevator stops and gross area of less than 5,000 m², provide a single elevator. (Note however, if one elevator would normally meet the requirements in the facility where elevator service is essential, two elevators shall be installed to ensure continuity of service. If financial limitations restrict the inclusion of a second elevator, as a minimum, a hoistway for a future elevator is recommended).
- For buildings with 4 or more elevator stops and the gross area above 6000 m² provide two elevators. If the gross area of the building exceeds 10,000 m² provide a group of three elevators.
- If distributed elevator configurations are used then the total number of elevators required shall be increased by approximately 60% to account for the inefficiencies of the distributed arrangement and imbalances in demand.

Two lifts of 680 kg provide a better service than one 1360 kg. The large single lift would run only partly loaded during the major part of the day with a resulting decrease in efficiency and increased running cost. The offset is that although 2 lifts may be costly, require more foot print (space) and have less tenable area; the advantage is the lower operating costs and better quality of service.

Speed of Elevators

Elevator speed is determined by travel distance and standard of service. The speed should be selected such that it will provide short round time and 25 to 30 second interval, along with least number of elevators to handle the peak loads. The taller buildings above 20 floors may have high-speed lifts that do not stop at the first 10 floors. Car speed is chosen so that the driving motor can be run at full speed for much of the running time to maximize the efficiency of power

consumption. The overall speed of operation is determined by the acceleration time, braking time; maximum car speed; speed of door opening; degree of advanced door opening; floor-leveling accuracy required; switch timing and variation of car performance with car load.

The general rules of thumb, for the recommended elevator speeds for various travel distances are:

Floors	Car speed m/s
4	0.75
9	2
15	3
Over 15	5-7

The table above applies principally to commercial buildings; speeds in residential and institutional buildings may be subject to local design regulations.

Zoning of Elevators

Zoning implies subdivision of the floors of the premises into clusters of stops to be served by different elevator cars. This creates the need for people traveling to floors within that zone to use the same lifts, thereby reducing the probable number of stops made by the lifts. This in turn reduces the overall time lifts are accelerating and decelerating. With the reduction in time spent in obtaining full speed or stopping from full speed, the efficiency of the overall system is increased and so energy savings can be made.

For office buildings, a single elevator group can generally serve all floors in buildings up to 15 to 20 floors depending on the building population. The taller building more than 20 floors (up to about 35 floors), are best served by two different elevator groups; one serving the low rise and the other the higher floors. Such a zoning arrangement would cut down on the number of stops per elevator, thus reducing round trip times and increasing the handling capacity of each group. Other advantage is that the low rise group won't need high speed elevators, thus providing an economical and energy efficiency solution.

The same principle can also be deployed for low rise buildings of say 10 floors in a different way. A typical example is separating elevator systems to serve even number floors and odd number

floors. If the average waiting time is too long, passengers will call for both lift systems and travel one floor by stair.

Location of Elevators

The location of elevators shall be such that they are easily accessible and convenient to circulation routes. When planning the location of elevators, the following principles shall be observed:

- Elevators should be located so that the building entrances with the heaviest traffic shall have adequate elevator service. Elevators should be as near to the center of the building area served as practicable, taking into consideration the distance from the elevator bank or banks to the most distant functional areas do not exceed a maximum of 45 meters.
- Congestion at peak travel times is minimized by arranging the lift lobbies in a cul-de-sac of, say, two lift doors on either side of a walkway, rather than in a line of four doors along one wall. For passenger cars, three across are preferred, and not more than four in a row shall be used. Where four or more cars are required within a group, cars shall be placed in opposite banks, opening into a common lobby.
- As a general guide, the lobby width between two banks of passenger elevators shall not be less than 3600 mm (~12 ft) and the lobby width between two banks of service elevators should not be less than 4200 mm (~14').
- When designing the service core in relation to the floor plate, the designer must ensure that the elevator lobby should not be used as a common or public thoroughfare at ground-floor level.
- Where elevators are accessed from corridors, they shall be located on one side of the corridor only and shall be set back from the line of circulating corridors. Elevator ingress/egress shall be from a distinct elevator lobby and not directly from a corridor.
- Elevator lobbies generate noise and shall be acoustically isolated from areas sensitive to noise and vibration. Elevators shall not be placed over occupied spaces as this shall require counter-weight safeties and reinforced pits.

- Egress stairs shall preferably be located adjacent to elevator lobbies when possible.
- Any decentralized banks and/or clustering of elevators shall be planned to include at least two cars to maintain an acceptable dispatch interval between cars and to ensure continuity of service.
- Elevators shall preferably provide positive separation between passenger and freight /service traffic flows.
- In facilities that utilize interstitial floors and mechanical penthouses, at least one elevator shall stop on these floors to facilitate equipment maintenance and removal.

Elevator Doors

The doors protect riders from falling into the shaft. The door opening shall be capable of opening doors at the rate of 0.9 m/s. This is a capability speed, with actual speed being adjusted to meet the requirements of the specific installation. The closing speed shall be set per ASME/ANSI A17.1. All power operated doors shall be equipped with an automatic reopen device for passenger protection.

Door configuration and door opening

The most common configuration is to have two panels that meet in the middle, and slide open laterally.

- Single-speed bi-parting doors are typically used in the larger capacity ranges and when dictated by the shaft and platform arrangement. Their operating speed is generally faster than side-acting doors.
- Two-speed bi-parting doors have the fastest action and are used where a wide opening is required; they are common on large passenger elevators and service elevators.

A cascading configuration is sometimes used for wider opening of service elevators where the doors are tucked behind one another, and while closed, they form cascading layers on one side.

The clear opening (width and height) of an entrance depends on its application.

- For passenger elevators and handicap access, a minimum door opening width of 1070 mm (3'-6") and height of 2135mm (7') is recommended.

- Combined passenger/ service elevators typically have doors at least 1220 to 1320 mm (4'-0" to 4'-4") wide and 2135 to 2440 mm (7'-0" to 8'-0") high.
-

SECTION – 2

TYPES OF ELEVATORS

The two main types of elevators are hydraulic and traction.

Selection of the best-suited type of elevator considers initial cost of the elevator plus the building structure needed to house the lift, maintenance costs over the life of the building and running costs.

TRACTION ELEVATORS

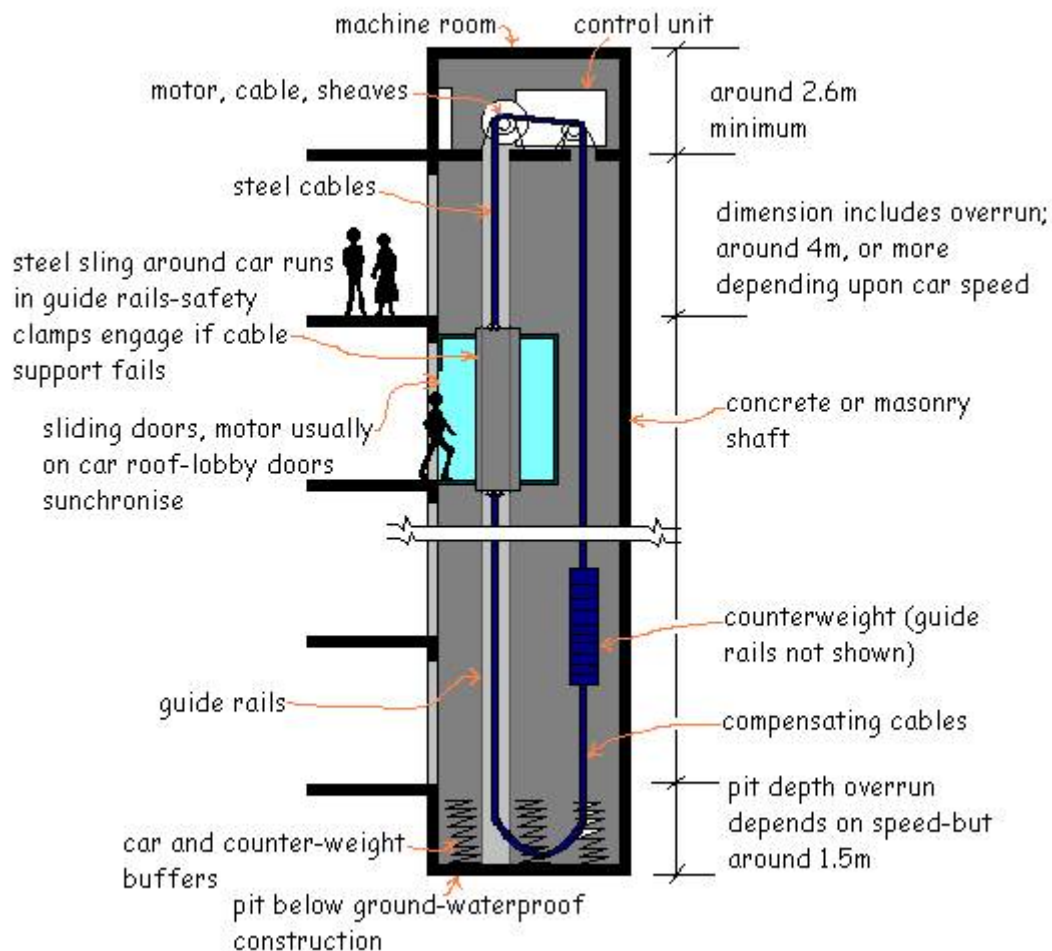

Traction elevators are the most popular form of elevator designs used widely across the world. These consist of the elevator car and a counterweight held together by steel ropes looped around the sheave. The sheave is a pulley with grooves around its circumference. The sheave is driven by the AC or DC motor. The sheave grips the hoist ropes so that when it rotates, the ropes move, too. This gripping is due to **traction**.

Roping Arrangements

A roping system is used to attach the motor/gear reducer, the elevator car and the counterweight. There are many different kinds of arrangements that can be used; the two most common are:

1. One to One roping (1:1) also called traction drum arrangement
2. Two to One Roping (2:1) also called lifting drum arrangement

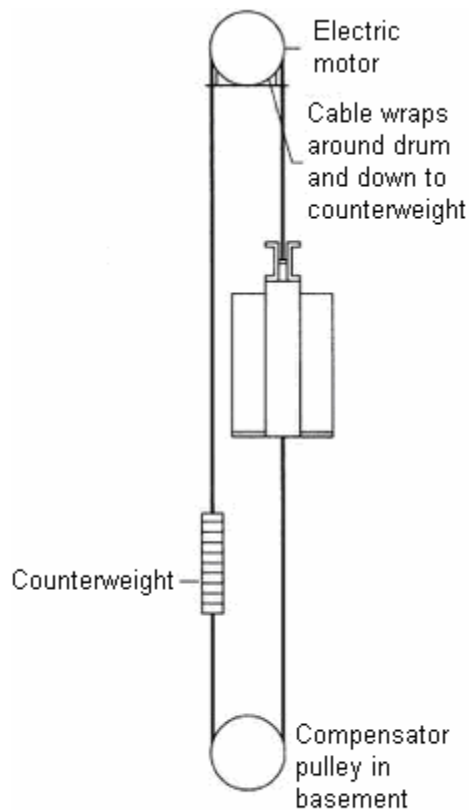

Traction Drum Arrangement

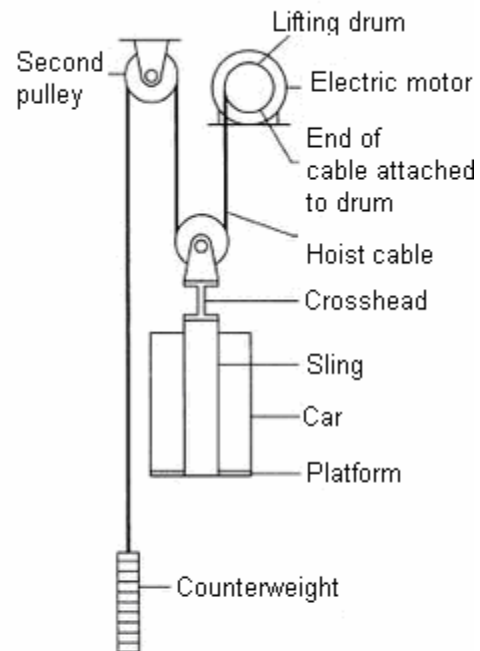

Lifting Drum Arrangement

One to One roping (1:1) or Traction Drum Arrangement

In a One to One roping (1:1) arrangement, the hoist ropes runs from the elevator car hitch over the machine sheaves to the counterweight hitch. The elevator car and the counterweight each run in their own sets of guide rails. A second governor cable runs from the car up to a governor pulley, then down to a tension pulley at the bottom of the elevator shaft, and up to the car again. This cable rotates the governor pulley at a speed directly proportional to the speed of the car. In

the event of excessive car speed, the governor uses another cable to activate the emergency brake jaws which grip the guide rails and slow the car to a stop.

Two to One Roping (2:1) or Lifting Drum Arrangement

Arrangement of hoist ropes in which one end of each hoist rope passes from a dead-end hitch in the overhead, under a car sheave, up over the drive sheave, down around a counterweight sheave and up to another dead-end hitch in the overhead. The car speed is one-half the rope speed.

Counterweight

When the traction drive is rotated, power is transferred from the traction drive to the elevator car and counterweight. The counterweight adds accelerating force when the elevator car is ascending and provides a retarding effort when the car is descending. *The counterweight is normally sized equal to the weight of the car plus approximately half its maximum rated capacity.* It saves energy equivalent to the unbalanced load between the elevator and the counterweight both when the car is travelling full and empty. The counterweight also ensures that the elevator cannot fall out of control while the cable is intact.

Hoist Mechanisms

An elevator's function is to convert the electrical power, which runs the motor, into mechanical power. There are two types of hoisting mechanisms: Geared and Gearless types.

Geared type:

In a geared machine, the motor turns a gear train that rotates the sheave. Geared traction machines are used for medium-speed applications and have effective speeds from 0.5 m/s (100 fpm) to 2.0 m/s (400 fpm). The slower speeds are for freight operation, while the higher speeds are typically used for passenger service in mid-rise buildings of ten stories or less.

The geared elevator system most commonly use a worm gear reducer, which is composed of a worm gear, typically called the worm, and a larger round gear, typically called the worm gear. These two gears which have rotational axes perpendicular to each other that not only decreases the rotational speed of the traction pulley, but also change the plane of rotation. By decreasing the rotation speed, we are also increasing the output torque, therefore, adding the ability to lift larger objects for a given pulley diameter. A worm gear is chosen over other types of gearing possibilities because of its compactness, precise speed control, quiet operation and its ability to

withstand higher shock loads. It can also be easily attached to the motor shaft and has high resistance to reverse shaft rotation.

The efficiency of the gear train is a consideration in the selection of the type of hoisting machine. Following key facts should be noted, when specifying geared machines:

1. The efficiency of the gear train depends on the lead angle of the gears and the coefficient of friction of the gear materials. The lead angle is the angle of the worm tooth or thread with respect to a line perpendicular to the worm axis. As this angle approaches zero degrees, the reduction ratio increases and the efficiency decreases due to increased sliding along the gear teeth. For optimum efficiency, the lead angle should be high usually in the range of 50% to 94%.
2. The efficiency also depends on the operating parameters of the gear train. Usually, smaller reduction ratios, higher input speeds, and larger gear reducer sizes shall result in greater efficiencies. However, it does not mean to intent ally over-size the gear train because the large gear train will operate less efficiently at partial load condition. The gear reduction ratios typically vary between 12:1 and 30:1.

Geared Traction machines can be driven by AC or DC motors. The machines are normally located overhead, directly over the hoistway but can be mounted to the side and below; and when this is done, it is termed as "basement traction" application.

The disadvantage of geared hoisting is that the gear train will loose some energy due to friction and thus the transmission efficiency of geared elevator is inferior to gearless machine.

Gearless type:

In gearless elevators the motor turns the sheave directly. A brake is mounted between the motor and drive sheave to hold the elevator stationary at a floor. This brake is usually an external drum type, which is actuated by spring force.

Gearless traction elevators are specified for high-speed applications having effective speeds varying from 2.5 m/s (400 fpm) to 10.0 m/s (2000 fpm). These are generally used on taller structures with more than 10 stories. In terms of energy performance, gearless drive has no gear transmission loss thus have a transmission efficiency of 100%.

Gearless traction machines use low torque electric motors (generally DC motors) driven by motor generator (MG) drive or silicon-controlled rectifiers (SCR). Modern gearless traction machines use variable-voltage; variable frequency (VVVF) drives systems.

ENGINEERING DESIGN

The traction drive depends on the friction, or traction, between the hoisting ropes and the drum. The hoisting ropes are wound over the drum (possibly several turns are made) and down to the counter weight, which compensates for the weight of the empty elevator car and vastly reduces the power needed by the hoisting motor.

The friction between the ropes and the sheave grooves, which are cut on the pulley, initiates the traction force between the traction drive and the rope. ASME A17.1 mentions that sufficient traction shall be provided between the rope and groove to safely stop and hold the car with rated load in the down direction. In most mechanical systems, considerable emphasis is placed on reducing friction between parts; the reverse is the case in elevators. A lot more importance is given to utilizing friction for traction-driven machines. In layman's terms, traction is the gripping force along the surface. In technical terms, traction is the frictional force.

Traction Calculation

Consider a rope passing over a driving sheave. Let T_1 be the tension in the car side, and T_2 in the counterweight side.

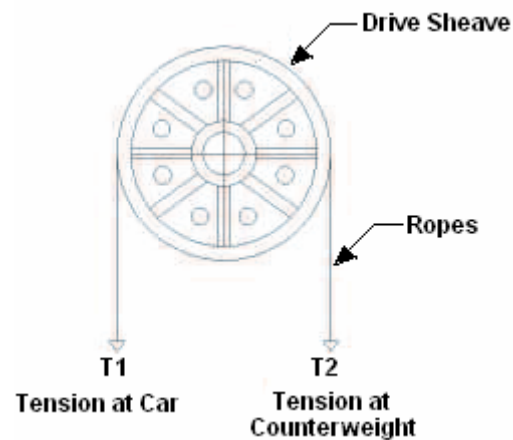

The required traction for the elevator system is expressed as T_1 / T_2 .

T1 is the addition of all weights (i.e. 125% of rated load, car weight and traveling cable weight), whereas T2 is the tension at counterweight.

The maximum available traction that can be developed is a function of the actual coefficient of friction between the rope and groove, the shape of groove and angle of contact. Maximum available traction = $e^{f\Theta}$

Where

- e = the base of natural logarithm
- f = coefficient of friction
- Θ = angle of contact

Hence the condition so that the elevator does not lose traction is given by:

$$T1/T2 * C < e^{f\Theta}$$

Where, C is a constant, considering acceleration and deceleration, and is given by:

$$C = (gn + a) / (gn - a),$$

Where

- gn = acceleration due to gravity and
- a = rated speed of the elevator.

Obviously, from the above expressions, we can conclude that the maximum traction can be achieved when the value of $f\Theta$ is increased.

Factors Affecting Traction:

1. **Sheave Diameter:** Available traction can be increased by increasing the arc of contact that the rope subtends with the sheave. The ratio of rope diameter to sheave diameter plays an important role in traction. As a good engineering practice, the sheave diameter should be equal to 40 times the rope diameter. The larger the sheave diameter, the more the contact area between the rope and sheave is achieved. The sheave diameter

should also be large enough to account for the bending stresses exerted by the ropes. However, cost is also to be considered while setting the final diameter. It will also result in a larger machine assembly, which will create problems during installation.

2. **Shape of the Groove:** Available traction can be increased by changing the shape of the groove.
 - The V-groove is the most widely used type of groove. These provide the greatest amount of bearing pressures, hence maximum traction. The angle of the groove is kept between 32° and 40° . Traction increases with decreasing angle of the groove, but it also leads to shorter rope life.
 - The U-groove is the sheave of choice for optimum life. Its large size, in combination with its supportive grooves, minimizes abrasion and fatigue. The groove cradles the rope, resulting in low groove pressures, allowing the wires and strands to move about freely while the rope is operating. Unfortunately, however, the U-grooved sheave provides the least amount of traction.
3. **Coefficient of Friction:** Lastly but not the least, the available traction can be increased by increasing the actual coefficient of friction of the material.

Note that all the above parameters are dependent on one another. Compromising on any of the above factors should not change the final traction value. With this background, elevator system designers need to be very careful in estimating traction and establishing their designs.

CONSTRUCTION OF TRACTION ELEVATORS

The elevator car itself is constructed with a steel framework for durability and strength. A set of steel beams above the car, called the crosshead, span the elevator shaft from side to side and hold the pulley for the hoist cable. A steel structure, called the sling, extends down the sides of the car from the crosshead and cradles the floor, or platform. The sides of a passenger elevator car are usually made from steel sheet and are trimmed on the inside with decorative paneling. The floor of the car may be tiled or carpeted. Handrails and other interior trim may be made from stainless steel for appearance and wearability. A suspended ceiling is usually hung below the actual top of the car and may contain fluorescent lighting above plastic diffuser panels. The

elevator controls, alarm buttons, and emergency telephone are contained behind panels in the front of the car, next to the doors.

In a simple installation, the lift shaft of concrete or masonry forms the part of service core. Guide rails run the length of the shaft to keep the car and counterweight from swaying or twisting during their travel. Steel guide rollers or guide shoes are attached to the top and bottom of the sling structure to provide smooth travel along the guide rails. The emergency brake mechanism consists of two clamping faces which can be driven together by a wedge to squeeze on the guide rail. The wedge is activated by a screw turned by a drum attached to the emergency cable.

For further details, refer to Section-3 “Design Criteria of Elevator Systems”.

HYDRAULIC ELEVATORS

Hydraulic elevator systems lift a car using a hydraulic ram, a fluid-driven piston mounted inside a cylinder. All the weight of the elevator cab is supported on the piston.

The cylinder is connected to a fluid-pumping system (typically, hydraulic systems like this use oil, but other incompressible fluids would also work). The hydraulic system has three parts:

- A tank (the fluid reservoir)
- A pump, powered by an electric motor
- A valve between the cylinder and the reservoir

The pump forces fluid from the tank into a pipe leading to the cylinder. When the valve is opened, the pressurized fluid will take the path of least resistance and return to the fluid reservoir. But when the valve is closed, the pressurized fluid has nowhere to go except into the cylinder. As the fluid collects in the cylinder, it pushes the piston up, lifting the elevator car.

When the car approaches the correct floor, the control system sends a signal to the electric motor to gradually shut off the pump. With the pump off, there is no more fluid flowing into the cylinder, but the fluid that is already in the cylinder cannot escape (it can't flow backward through the pump, and the valve is still closed). The piston rests on the fluid, and the car stays where it is.

To lower the car, the elevator control system sends a signal to the valve. The valve is operated electrically by a basic solenoid switch. When the solenoid opens the valve, the fluid that has collected in the cylinder can flow out into the fluid reservoir. The weight of the car and the cargo

pushes down on the piston, which drives the fluid into the reservoir. The car gradually descends. To stop the car at a lower floor, the control system closes the valve again. The electric motor is redundant during descend.

This system is incredibly simple and highly effective, but it does have some drawbacks.

- Hydraulic elevators consume more energy. Considerable amount of energy is wasted in heating up the hydraulic fluid when building up the hydraulic pressure; some installations may even need separate coolers to cool down the fluid to avoid overheating.
- Hydraulic elevators are usually not provided with a counterweight. Thus the lift motor has to be large enough to raise the rated load plus the dead weight of the car cage. In traction lift, the maximum weight to be raised under normal operation is only about half of its rated load.
- Hydraulic elevators are used in buildings up to 5 floors (14 meters rise) and have rated speeds of 0.25 m/s (50 fpm) to 0.75 m/s (150 fpm).

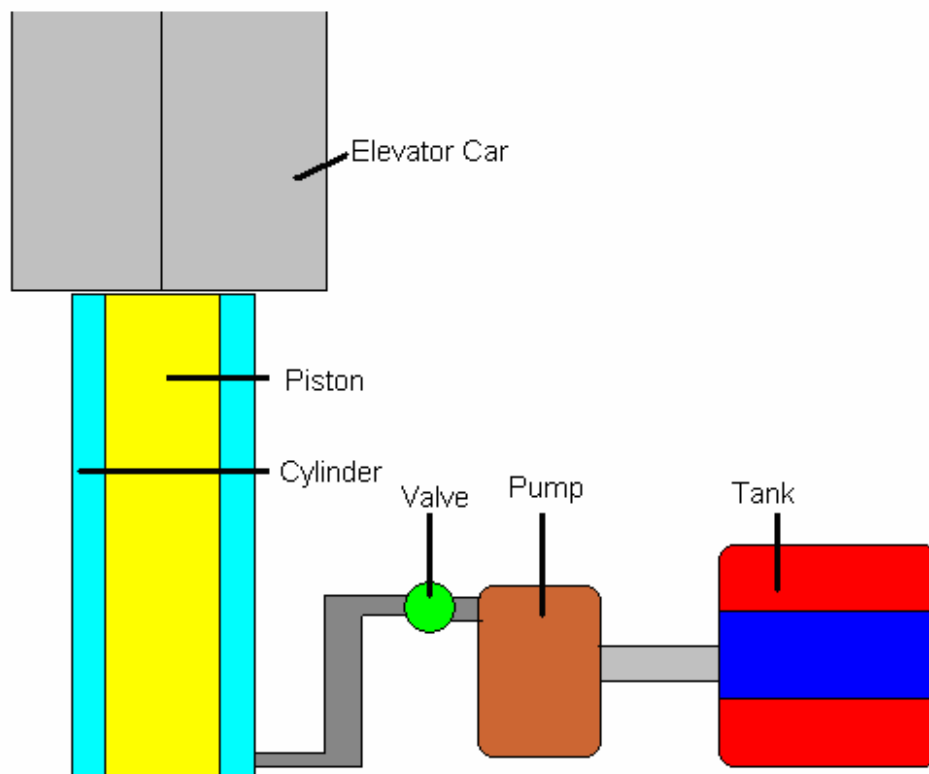

Basic Types of Hydraulic Elevators

The hydraulic lifts are of two types. They are

1. Direct-acting hydraulic lift, and
2. Suspended hydraulic lift

Direct acting hydraulic lifts:

The system consists of a ram which slides inside a fixed cylinder. The cylinder has suitable openings at the bottom for the hydraulic fluid to enter and also suitably designed to allow the ram to slide up and down. The ram is attached to the top of the car, which acts as a capsule carrying people or goods. The ram is pushed up by the pressure of hydraulic fluid acting beneath. Thus the cage moves up to various floors as per the need. The cage is moved in downward direction by allowing oil to get drained from the cylinder back to the oil reservoir. Guide rails are required to guide the ram in a vertical plane. Car speed up to 125 feet per minute (38.1 meters per minute) is attained and maximum travel length is 12 feet (3.6m).

Working: When the pump delivers oil to the bottom of the cylinder, as the valve meant for the re-circulation remains closed, the oil beneath the bottom of the ram gets pressurized and this pressurized oil lifts the ram (cage). When the cage has to be lowered, the oil is drained back to the oil reservoir by keeping the valve open. The time for which the valve is kept open is decided by the electro-magnetic switch, which gets its signal from the people who use the lift.

Suspended Hydraulic Lifts:

It has a cage (on which people can stand or goods can be placed), which is suspended from a wire cable, and a jigger consisting of a fixed cylinder, a sliding ram, and a set of two pulley blocks, which is provided at the foot of the hole of the cage. One pulley block is movable while the other one is fixed. The sliding ram end is connected to the movable pulley block. The cage is suspended from the other end of the rope. The raising or lowering of the cage of the lift is done by the jigger. This arrangement is used to increase the speed of the lift by a 2:1 roping ratio. Car speed up to 150 feet per minute is attained and maximum travel length is 48 feet (14m).

Working: Water or any hydraulic fluid at a high pressure is admitted into the fixed cylinder of the jigger. This high pressure hydraulic fluid pushes the sliding ram to move towards left side as shown in the figure. When the sliding ram moves towards the left side, the distance between the fixed and movable pulleys increases and thus the cage is lifted up. When the water or the hydraulic fluid under high pressure inside the cylinder is released, then the distance between the two pulleys decreases and thus the cage comes down. Thus the suspended-type hydraulic lifts are more popular than direct type lifts.

Besides the above basic arrangements, hydraulic elevators can also be installed with more than one cylinder. On some, the hydraulic piston (plunger) consists of telescoping concentric tubes, allowing a shallow tube to contain the mechanism below the lowest floor. On others, the piston requires a deeper hole below the bottom landing, usually with a PVC casing (also known as a caisson) for protection.

HOIST DRIVES

The motor component of the elevator machine can be either a direct current (DC) motor or an alternating current (AC) motor. A DC motor had a good starting torque and ease of speed control. An AC motor is more regularly used because of its ruggedness and simplicity. A motor is chosen depending on design intent for the elevator. Power required to start the car in motion is equal to the power to overcome static, or stationary friction, and to accelerate the mass from rest to full speed. Considerations that must be included in the choice of an acceptable motor are good speed regulation and good starting torque. In addition, heating of various electrical components in continuous service should not be excessive.

Various alternatives of hoist motor drives include:

- DC motor drive with motor generator set (DCMG);
- DC motor drive with solid state controller (DCSS);
- AC - 2 speed motor drive;
- AC motor drive with variable voltage controller (ACVV);
- AC motor drive with variable voltage and variable frequency controller (ACVVVF).

DCMG has large energy losses in the motor and generator arrangement, which converts electrical energy into mechanical energy and finally back to electrical energy again. DCMG drive is NOT recommended, due to its low inherent efficiency and also because its application requires it to be kept running when the elevator is idle.

The two speed AC motors are also considered energy inefficient. These two speed motors are usually started up with resistance in the high-speed winding, whilst smooth deceleration is obtained by inserting a buffer resistance, either in the low- or high-speed winding during

transition to low speed. The insertion of buffer resistance and choke wastes much energy during the start up and deceleration.

ACVV and ACVVVF systems are the most energy efficient option. ACVV requires approximately 70% of the input energy for the same output whereas ACVVVF will only require 50%. If the energy to be fed back into the mains supply is taken into account, a further reduction of 5% (i.e. 45%) of energy can be achieved for the ACVVVF.

In principle:

- Geared traction machines virtually use variable-voltage; variable frequency (VVVF) AC drives systems.
- Gearless traction machines use DC or AC motors. DC motors driven by motor generator (MG) are best suited when there is a possibility of fluctuating line voltage or the facility contains very sensitive electronic equipment. DC motors driven by silicon-controlled rectifiers (SCR) use less power and require less maintenance, however, they are currently more expensive than MG. Now days, virtually all new gearless traction machines use AC motors driven by the VV or VVVF drive.
- Hydraulic elevator applications typically use AC motors. Direct across-the-line starting is utilized for motors less than 40 hp and the larger ones use wye-delta starting.

Choice between Hydraulic and Traction Elevators

Hydraulic elevator

Hydraulic elevators operate at slower speeds and serve up to 14 meter of travel. These are recommended for light usage – low height installations.

Benefits

- Lower ownership costs;
- Quick installation;
- Doesn't need a penthouse or overhead support to house the machinery;
- Flexibility in the location of the motor room;

- Upon power failure the lift lowers to the ground floor and releases the door.

Drawbacks

- Noisy, slow and poor ride quality;
- High on energy consumption;
- May cause potential environmental damage from leaking hydraulic fluid.

Traction Elevator

Roped traction elevators are much more efficient and safer. Geared traction elevators typically serve mid-rise buildings with speeds ranging 0.5 to 2.0 m/s and gearless traction elevators can serve buildings of any height with speeds of 2.5 m/s and higher.

Benefits

- Faster and smoother ride;
- More energy efficient;
- Cost little more to buy.

Speed Comparison

The speed of the elevator shall be within the following ranges and chosen to suit the specific building requirements as part of the elevator traffic analysis:

- Hydraulic passenger elevators - 0.25 to 0.75 m/s;
- Geared traction passenger elevators - 0.5 to 2.0 m/s;
- Gearless traction passenger elevators - 2.5 m/s and greater.

Lift Comparison

The lift of the elevator shall be within the following ranges and chosen to suit the specific building requirements as part of the elevator traffic analysis:

- Hydraulic passenger elevators – 15 meter rise up to 5 storeys;

- Geared traction passenger elevators – 30 meter rise up to 10 storeys;
- Gearless traction passenger elevators – above 10 storeys.

Machine Room-less Elevators

All elevators, whether traction or hydraulic, require a machine room to store large electric motors (or hydraulic pumps) and a controller cabinet. This room is located above the hoistway (or below, for hydraulic elevators) and may contain machinery for a single or a group of elevators.

The most significant development in the recent history of elevators has been the introduction of Motor Room Less (MRL) elevators. Most MRL solutions are based on **gearless technology**. Traditionally in motor room configurations the sheave, motor and control system are all housed in a machine room above the elevator shaft but in MRL elevators, the machinery is installed in the elevator shaft itself.

This was made possible by the development and application of permanent magnet (PM) system technology in the lift motor that reduced the size of the motor by up to four times. For example, a 6.5kW motor used in a MRL configuration can perform the same task as a conventional 16.8kW traction machine. Smaller motors also use less energy. Technical developments such as increasing the density of the armature winding in the PM and applying their own proprietary joint-lapped core, further reduced the motor dimensions while improving its power output. To date the focus from all manufacturers has been on maximising the power output of the motor while reducing its physical size.

MRL installations are generally cheaper to install, give greater architectural flexibility and increased lettable space. Presently the speed and number of floors limit their installation - MRL solutions range up to 30 floors and can reach up to speeds of 2.5m/s.

Since the application of MRL technology is relatively new and due to the very fact that each of the major manufacturers provides propriety products, maintenance needs careful consideration. Therefore when evaluating the technical aspects the end-user or building owner should be aware of the potential pitfalls of being trapped into a high cost maintenance contract and left with no alternative.

NOTE that the ASME A17.1 code does not specifically address MRL design.

SECTION – 3

ELEVATOR DESIGN CRITERIA

Governing Codes:

Elevators design shall comply with the latest edition of ASME A17.1, “Safety Code for Elevators and Escalators” with amendments and Uniform Building Code (UBC). Other equally important standards that govern the design of an elevator include:

1. **ADA/ABA** - American with Disabilities Act (ADA) Accessibility Guide Lines for Building and Facilities; Architectural Barriers Act (ABA) Accessibility Guide Lines.
2. **ADAAG** - American Disabilities Act Accessibility Guide Lines
3. **ASCE-7** - America Society of Civil Engineers (Minimum Design Loads for Buildings and Other Structures)
4. **ASME A17.1** - American Society of Mechanical Engineers Safety Code for Elevators and Escalators.
5. **ASME A17.2.1** - Inspector’s Manual for Electric Elevators.
6. **ASME A17.2.2** - Inspector’s Manual for Hydraulic Elevators.
7. **ASME A17.2.3** - Inspector’s Manual for Escalators.
8. **ASME A17.3** - Safety Code for Existing Elevators and Escalators (For designing changes to existing Elevator/Escalator Systems)
9. **NEII** - National Elevator Industry, Inc. (1992) –Vertical Transportation Standards
10. **NFPA 70** - National Electric Code (NEC)
11. **NFPA 80** - Fire Door and Fire Windows
12. **NFPA 99** - Health Care Facilities
13. **NFPA 101** - Life Safety Code
14. **UBC** - Uniform Building Code

15. **UFAS** - Uniform Federal Accessibility Standards

International Elevator Standards:

- Australia - AS1735
- Canada - CAN/CSA B44
- Europe - EN 81 series [EN 81-1 (electrical elevators), EN 81-2 (hydraulic elevators), EN 81-28, EN 81-70, EN 12015, EN 12016, EN 13015, etc.]

The various codes may have conflicting requirements or have many potential pitfalls. But by understanding how these fit together and what purpose they serve, you can have a successful project. Always verify all conditions and requirements with the state and the AHJ where the installation is taking place. ASME/ANSI A17.1, A17.2, A17.3, and A17.5 usually take precedence over all other codes in US unless specifically advised.

ARCHITECTURAL DESIGN CRITERIA

Elevator runs in a hoistway built within the “**Service core**”. Service core is one of the most important aspects of high rise buildings - the design of this is predominantly governed by the fundamental requirements of meeting fire-egress regulations, achieving basic efficiency in human movement, and creating an efficient internal layout. Typically the service core provides the principal structural element for both the gravity load-resisting system and lateral load-resisting system, with the latter becoming increasingly important as the height of the building increases. The core provides the stiffness to restrict deflections and accelerations to acceptable levels at the top of the building. The cost of a core for a typical high rise building is estimated to be around 35 to 40 percent of the total structural cost, or 4 to 5 percent of the total development cost.

Elevator Shafts within the Service Core:

Once the location of the service core is determined, the exact size of the core (internal shaft dimensions, wall thickness, etc.) needs to be established.

It is next necessary to define design criteria for the services shaft and the elevator system. Early liaison with the fire officer is important in establishing life-safety requirements.

The fire department may require fire compartmentation between the elevator lobby and elevator shafts. A separate fire-fighting elevator — capable of moving firefighters around a burning building when all other lifts have returned to their neutral position — is often required.

In organizing the configuration of elevator banks in the service core, it is necessary to ensure that a bank of two, three, or four elevators in line shares a common fire-protected shaft without a dividing structure, so avoiding a single enclosed elevator shaft. If single enclosed elevator wells are necessary for structural reasons, the designer must ensure that air relief slots (ideally, full-height vertical slots) to allow adequate air relief.

Note - The core configuration is normally finalized at an early stage of design development because of its implications for the functional layout of the building. Traditionally, the configuration is greatly influenced by the architect. The design optimization process is subsequently carried out by the structural and building services engineers. A large bank of elevators is the main element in a service core design and all other elements are designed around it.

STRUCTURAL DESIGN CRITERIA

The elevator cars are built at the elevator manufacturer's plant using standard metal cutting, welding, and forming techniques. The rest of the elevator is assembled on the building site. Elevator shafts are sized according to car shapes and sizes and door sizes, with due consideration given to space requirements for guide rails and brackets, counterweight systems, running clearances, and ancillary equipment. Sufficient air space should always be provided around cars and elevator counterweights to minimize buffeting and airborne noise during operation.

The building design integrates the elevator shaft from the beginning, and the shaft grows as the building is erected. The walls of the shaft are poured concrete, and the shaft straightness and other dimensions are carefully monitored as each floor goes up.

Guide rails, switch ramps, service ladders, and similar support equipment are bolted into the shaft after the shaft walls are complete, but before the shaft is roofed. While the shaft is still open at the top, a crane raises the counterweight to the top of the building and lowers it into the shaft along its rails. The crane then lifts the elevator car and inserts it partly into the shaft. The guide wheels connect the car to the guide rails, and the car is carefully lowered to the bottom of the shaft.

The shaft is then roofed over, leaving a machine room above the shaft. The hoist motor, governor, controller, and other equipment are mounted in this room, with the motor located

directly over the elevator car pulley. The elevator and governor cables are strung and attached, the electrical connections completed, and the controller programmed.

The structural design of elevator is governed by ASME 17.1 and **ASCE-7**, in addition to local codes and standards. The following key points should be noted:

Hoistway:

1. Construction of the hoistway enclosure should be fire resistant, generally 2-hour fire rating and in accordance with the applicable building regulations. All penetrations for services through the walls of the service core need to be designed to maintain fire integrity for the prescribed period of time.
2. All elements that are part of the elevator system, particularly guide rail tie brackets, intermediate spreader brackets and framing, as well as supports and attachments for driving machinery shall be spaced dictated by seismic conditions, design particulars and codes. It is important to avoid the use of tile or brick hoistway walls.
3. Beveling of the top surface of projections and setbacks in the hoistway enclosures shall be in accordance with Rule 100.6 of ASME 17.1.
4. A vertical surface is needed for attachment of sill angles to the floor slab on each landing where an entrance is required; or otherwise consider a notch on the top edge of each floor slab on the entire width of the hoistway to accommodate landing sills.
5. Where the hoistway enclosure is concrete construction, provide rough openings for hoistway entrances and grouting following installation. Where drywall hoistway construction is utilized, erect walls around previously installed hoistway entrances. Deviation from plumb for the hoistway enclosure should not exceed ± 25 mm (1 inch) per 20 stories of height.
6. Provide rough openings for control/signal fixture recessed mounting boxes and grouting thereof as required to maintain fire resistive characteristics of the hoistway enclosure.
7. On hydraulic elevators, sprinkler protection is required at the top of the hoistway when the hydraulic cylinder or supply piping extends above the second finished floor elevation. On hydraulic elevators, the hydraulic oil lines shall remain in or under conditioned space

within the building footprint. Consider straight pipe run in PVC pipe sleeves for oil spill containment of all buried hydraulic lines between machine room and the hoistway.

Don'ts

- Avoid locating building expansion joints between the elevator hoistway and elevator room.
- The elevator code does NOT allow anything to be installed in the hoistway not related to the elevator operation. Pipes, ducts and conduit not related to the elevator system are NOT allowed to penetrate the hoistway.

Elevator Pit:

1. Elevator pit shall meet the ASME A17.1 Code requirements. Elevator pit shall be waterproofed as required by site conditions and codes.
2. Pit shall have a concrete floor reinforced as necessary to withstand vertical forces of elevator car or counterweight buffer impact, application of car or counterweight safeties to guide rails, or operation of the hydraulic jack.
3. Pit shall have a sump in a front corner with a removable steel subway-type grating installed level with the pit floor. The sump shall be constructed to minimum dimensions of 610 mm (2 ft) cubed.
4. Where the difference in depth between adjacent pits is more than 610 mm (2 ft) provide a means of separation extending from the pit floor to a height of not less than 1830 mm (6 ft). Perforated materials used for the separation of pits shall reject passage of a 50 mm (2.0 inch) diameter ball.
5. Where pit access is greater than 915 mm (3 ft) in depth and is via the lowest hoistway entrance, provide a permanently installed pit access ladder, accessible from the hoistway entrance, extending from the pit floor to no less than 1065 mm (3'-6") above the bottom landing sill.
6. Where conditions allow and pit depth is 2440 mm (8 ft) or greater, provide a walk-in access door with clear opening dimensions of not less than 760 mm (2'-6") wide by 1830

mm (6 ft) high. This door shall be equipped with a self latching lock mechanism (key-entry only), automatic closing device, and signage to prohibit unauthorized entry.

7. A buffer access ladder shall be provided whenever the buffer oil level gauge is located more than 1525 mm (5 ft) above the pit floor. A buffer inspection platform and access ladder shall be provided whenever that dimension is greater than 2135 mm (7 ft).
8. On hydraulic elevators, sprinkler protection is required in the pit of each elevator.

Don'ts

- An elevator pit floor drain is NOT acceptable by codes. Elevator pit must have floor sump pit and pump sized for a minimum 20 gallons per minute. Permanent drainage installations require consideration of environmental regulations governing the discharge. Pump to sanitary sewer through a 2" (50 mm) air gap or directly through an oil/water separator to storm sewer, or to grade outside the building line is sometimes permissible in accordance with discharge permits, regulations, and statutes.

Machine Room:

1. Elevator machine rooms shall be large enough for the elevator equipment, including space for controllers. Machine rooms and secondary machinery spaces shall provide required clearances around the equipment and it should be possible to remove major equipment components of each elevator for repair without dismantling components of an adjacent elevator. Minimum headroom shall be 2300 mm (7'6").
2. Elevator machine rooms shall be of fire resistant construction (generally 2 hour equivalent to hoistway construction). Machine room door (exiting to the interior of the building) shall be "B" Label, fire rated 1½ hour with automatic closure, latching door hardware, panic hardware exit device from interior of room, and key operated hardware from outside of room only.
3. Elevator machine rooms access doors shall conform to ASME A17.1 Code. Access doors to elevator machine rooms and secondary machinery spaces shall be of the self-closing and self locking type. They should be provided with spring-type locks arranged to permit the doors to be opened from the inside without a key.

4. Where machine room and/or secondary machinery space floor levels is above or below the point of access, provide fixed, permanent, noncombustible stairs with a maximum angle of 60 from horizontal.
5. Provide support for machine beams and grouting thereof after installation. Whenever possible, place machine beams on top of building steel in such manner as to be flush with the machine room floor.
6. Provide an overhead hoisting beam in the machine room, installed directly above the hoistway, sized in accordance with the requirements of the elevator manufacturer.
7. All openings in the floor for passage of hoist ropes, etc. shall have a 50 mm (2 inch) high concrete curb or 50 mm (2 inch) high metal sleeves.

Don'ts

- Machine room door shall NOT contain ventilation louvers or undercuts in excess of NFPA 80, Section 1- 11.4 requirements.
- Exposed spray on fireproofing shall NOT be used in elevator machine room.
- Skylights shall NOT be installed in elevator machine rooms.
- Drains or sumps shall NOT be provided in elevator machine rooms. The room should be made reasonably watertight. Curbs may be provided at the doors to prevent the ingress of water. Overhead fluid piping shall not be permitted in the machine room, except for sprinkler piping, if required. Pipes, ducts and conduit not related to the elevator system are not allowed to penetrate the machine room. Refer ASME A17.1 (Rule 101.2, Equipment in Machine Rooms).

Clearances:

The design of elevator systems is dependent on providing proper clearances around equipment and at the top and bottom of the hoistway. Most clearances are dictated by the Elevator Code, ASME A17.1. Other clearances have been established by elevator manufacturers based on their equipment. Care shall be taken to consider several elevator manufacturers' requirements and design for the "worst case" to allow maximum opportunity for competitive bidding. The

following represents some of the elevator code-related clearances which shall be considered in design:

1. Pit depth is based on the thickness of the platform, the safety plank, the run-by (set by code), and the buffer stroke (set by code based on speed), plus a minimum bottom-of-car clearance when the car is on compressed buffer.
2. Top terminal over-travel is based on the cab height (determined by designer), shackle clearance (determined by elevator industry), crosshead thickness (determined by elevator industry), and run-by (determined by code).
3. Clearances for items such as counterweight space, rail space, machine and controller size, machine room height, top & side emergency exits and area of safe refuge on top of cab shall be based on the manufacturers' recommendations and are also related to control and operation.

ELECTRICAL DESIGN CRITERIA

Machine Room Supply:

1. Each elevator shall be provided with a separate three phase supply through a lockable safety disconnect device, located adjacent to the door of the equipment room. This device must be either a fused disconnect or a circuit breaker because ANSI/ASME A17.1 requires to install an additional over-current protection device (OCPD) in the elevator equipment room.
2. Each elevator machine room shall be provided with a minimum of one ground type duplex receptacle outlet per elevator, and one receptacle for the master intercom panel; NEC 620-23 and NEC 620-85. Machine room shall be equipped with a 120 volt/20 ampere minimum, ground fault circuit interrupter (GFI) – protected duplex receptacle capable of locking in the off position. The circuit breaker panel shall contain:
 - A separate circuit to each elevator for fan, lights and alarm;
 - A separate circuit for the machine room lights;
 - A separate circuit for the machine room receptacles;

- A separate circuit for the hoistway lights;
 - A separate circuit for hoistway receptacles;
 - Each hydraulic elevator shall be provided with a separate circuit for the scavenger pump in the pit.
3. Provide a separate insulated feeder and grounding conductor from the electrical source to the elevator controller. The conduit alone can NOT act as the grounding means.
 4. All conductors and optical fibers located in the machine room shall be in conduit.
 5. Where a feeder powers more than one elevator, the OCPDs must be series-designed so a fault at one of the elevators shall be cleared by only the OCPD serving it. The feeder OCPD needs to remain closed so the remaining elevators have power and continue to function.
 6. Designer shall consider types of hoist drives specified, i.e., Silicon Controlled Rectifier (SCR), Variable Frequency Drive (VFD), motor generator, etc., and size service and wire for the worse case. Consider individual isolation transformers and individual choke reactors for each hoist motor and harmonic distortion filter units when SCR or Variable Voltage Variable Frequency (VVVF) AC controllers are utilized.
 7. The elevator supply shall be dedicated main feeder utilizing the shortest practical run and continuous ground conductor. The supply should terminate at the respective elevator controller.

Elevator Pit Supply:

1. Sump pump shall be provided with a twist lock simplex receptacle with matching plug, without GFI protection. Provide pilot lamp to verify circuit is energized. NEC 620-85.
2. A separate branch circuit shall be provided for the hoistway pit lighting and at least one duplex receptacle in the pit. All duplex receptacles in the pit shall be GFI. NEC-24, NEC 620-85.
3. Locate permanent vapor tight light with wire guard at a centerline height of 2440 mm (8 ft) above the pit floor and capable of producing at least 54 lux (5 footcandles) of illumination

at floor level, and a light switch inside the pit, accessible from the pit access door and adjacent to the pit access ladder, if used.

Don'ts

- When sprinklers are provided in the elevator pit, activation of the sprinkler is not required to initiate shutdown of elevator power.

Elevator Hoistway:

1. Only electric wiring, raceways, and cables used directly in connection with the elevator shall be permitted inside the hoistway (Refer NEC 620-37).
2. All conductors and optical fibers located in the hoistway, except for the traveling cable, shall be in conduit.
3. When a replacement or upgraded elevator is installed in an existing hoistway, any utilities and services (conduit, control wiring, etc.) not associated with the elevator system shall be removed from the hoistway, as required by code.
4. Light switch shall be located on wall inside the hoistway adjacent to the top of the pit ladder in accordance with NEC 620-24.
5. When sprinkler protection is required at the top of the hydraulic elevator hoistway, actuation of that sprinkler(s) shall initiate operation of the elevator power shunt trip breaker(s). Provide smoke detection at the top of the hoistway whenever sprinklers are installed in the hoistway.

Emergency Power:

Elevator cab lights require emergency back-up power. If the building has emergency power available, use it to supply the cab lights. Otherwise, specify that the elevator supplier provide a battery back-up unit to power the lights in the event of an outage.

The new ADAAG guidelines require that emergency power be available to elevators that have four or more stories of travel above or below the accessible floor. If emergency power is used:

1. The disconnecting means required by NEC 620-51 must disconnect the elevator from normal power and from emergency power.
2. If more than one elevator is provided, determine (with activity input) how many elevators are to operate on emergency power.
3. Design the emergency power to be able to operate selected elevator(s) at rated loads and rated speeds.
4. System design must accommodate automatic sequential operation in order to bring all elevators to the designated floor level, as required by ASME A17.1 (Rule 211.3b Smoke Detectors) and provide selected elevator(s) with emergency power operations.
5. Provide manual override switch in main elevator lobby area(s) to override the automatic emergency power selection.
6. Provide emergency power for machine room cooling/ventilation equipment and hoistway
7. Ventilating equipment, if the elevator is on emergency power circuit. Provide an extra set of contacts on transfer switch (when emergency power is provided) and two-conductor 120-volt ac circuit in conduit from these contacts to junction box in machine room.

Ventilation and Air conditioning

1. Modern electronic elevator controls can be sensitive to temperature shifts. Air-conditioning is required in most conditions; gravity ventilation is not acceptable. Refer ASME A. 17.1 (Rule 101.5, Lighting and Ventilation of Machine Rooms and Machinery Spaces).
2. Heating, ventilation and cooling shall be provided in the machine room as necessary to maintain temperature within a range of 10-32°C (50-90°F) and relative humidity sufficiently low to prevent condensation in sensitive equipment. The most cost-effective HVAC design that shall accommodate these requirements should be selected.
3. Cooling is typically provided through the use of return air from adjacent air conditioned spaces as exhaust for the machine room, or via dedicated cooling units. Designs shall provide an ambient environment which maintains the temperature and humidity within the tolerances of the elevator equipment specified.

4. Where elevator control systems or equipment shall remain energized during the building's unoccupied hours, means should be provided to maintain machine room temperature and humidity without depending on main HVAC systems that could otherwise be shut down or set back.
5. If the elevator equipment has an emergency power supply, the machine room HVAC should also be on emergency power circuit.
6. The National Building Codes require that all elevator hoistways be vented to prevent accumulation of hot gases and smoke inside the hoistway. This requirement includes non-personnel elevators if equipped with the means for top of car operation by service personnel. The required vent shall be controlled by a motorized louver that is powered closed. This louver shall open upon loss of electrical power or by a signal from either a smoke detector or activation of the Fire Emergency Service in any other manner.
7. Where hydraulic elevators are installed in cold climates and subject to intermittent use, provide means to maintain the oil temperature within acceptable operating limits.

Communication:

The Americans with Disabilities Act Accessibility Guidelines for Buildings and Facilities (ADAAG) require the cab to have a special phone accessible by individuals with disabilities. In the event of a breakdown, that phone must automatically call a location staffed 24 hours a day.

High-rise buildings pose additional concerns. The Uniform Building Code requires two-way communications between the central command center and the elevators, each elevator lobby, emergency power rooms, and by entries into enclosed stairways (Section 403.5.3). Fireman telephone jacks and telephone cabling are typically sufficient for each of these locations. Firefighters can then use portable telephone handsets in combination with the jacks and cabling.

FIRE PROTECTION DESIGN CRITERIA

The vertical transportation of people within a high rise building also depends on local fire regulations. The fire department may require fire compartmentation between the elevator lobby and elevator shafts. A separate fire-fighting elevator — capable of moving firefighters around a burning building when all other lifts have returned to their neutral position — is often required.

Fire Alarm & Detection:

Dual-contact smoke detectors or addressable fire alarm system smoke detectors and control modules shall be provided at:

- All elevator lobbies;
- Top of the hoistway (only if sprinklers are provided at the top of the hoistway);
- Elevator machine room.

Smoke detectors, which are required in all elevator lobbies and elevator equipment rooms, must be connected to the elevator controllers directly by means of auxiliary contacts and wiring, or indirectly by means of output signals from the fire alarm control panel. If a smoke detector goes into alarm, it signals the elevator to go into “Fire Recall Function,” at which point the controller directs the elevator cab to travel to its pre-programmed designated landing, open its doors, and remain stopped there until the alarm clears;(as required by ASME A17.1 (Rule 211.3b, Smoke Detectors).

If the smoke detector at the designated landing goes into alarm, the elevator shall stop at a predetermined alternate floor, which is usually the floor above the designated floor. However, this can vary depending on building conditions and exterior grade. Therefore, there shall be two signals to the elevator control panel related to smoke detectors: one from the “designated floor” smoke detector and another combined signal from the smoke detectors at the other lobby landings and in the equipment room.

Regardless of the number of elevators, only one smoke detector is required at each floor lobby, but it must be located within 21 feet of every elevator door. Be sure to provide a horn/strobe alarm in large equipment rooms because they can be noisy, isolated places.

If a hydraulic elevator loses power because a heat detector goes off — or for any other reason — it could trap occupants for an unpleasant amount of time. To avoid this situation, designers can specify elevator controls with a safety feature commonly called a **rescuator**. Upon loss of power, the rescuator controls the cab, lowers it to the designated floor, and opens its doors. If you specify a rescuator, you must also specify a disconnect switch with an auxiliary contact that opens when the disconnect arm moves to the open position, but stays closed when the

OCPD trips. This switch shall ensure that the elevator won't descend into the elevator pit and allow maintenance people to work safely in the area beneath the cab.

Detectors shall be connected to building fire alarm system in accordance with NFPA 72. Only elevator smoke detectors shall initiate automatic emergency recall.

Fire Water Spray Protection:

In buildings required to be fully sprinklered, automatic sprinklers shall be provided in elevator hoistways and machine rooms as required by NFPA 13. In accordance with NFPA 13, Sprinklers are required:

- Hydraulic Elevators Hoistways – YES
- Traction Elevators Hoistways – NO
- Traction Elevators Machine Room – YES
- Hydraulic Elevators Pit – YES

Key Features

Waterflow Switches and Valves:

1. A waterflow switch, outside stem and yoke (O.S& Y) control valve and check valve assembly shall be provided for the elevator sprinklers.
2. The control valves shall be located outside of and adjacent to the protected elevator machine room or hoistway.
3. A separate waterflow switch, O.S& Y valve and check valve assembly shall be provided for each floor level where elevator machine room or hoistway sprinklers are located.
4. Control valves shall be readily accessible to qualified personnel, but should NOT be readily accessible to the general public.
5. An inspector's test connection with outside discharge shall be provided for each waterflow switch. Sprinkler heads shall be standard heads with intermediate temperature classification.

Heat Detectors:

- A fixed temperature heat detector, rated at 57-60°C (135-140°F), shall be provided within 610 mm (2 ft) laterally of each sprinkler head located in the elevator machine room. Activation of a heat detector shall cause shunt trip breaker(s) to disconnect the main line power to the affected elevator. The actuation of heat detector(s) shall cause a “supervisory alarm” on the building’s fire protective signaling system, if provided. No heat detectors are required in the traction elevator hoist way.

Automatic Power Shutdown

To safeguard the passengers and electrical equipment, ASME A17.12.8.2.3.2 requires the power source to the elevator control panel to shut down prior to the discharge of water from a sprinkler head. The shut down shall be activated by operation of a shunt-trip breaker in the main line power supply. Depending on your local codes, this can be achieved by installing heat or smoke detectors within 24 inches of the sprinkler heads. Actuation of such heat detector or sprinkler head shall cause the following sequence of operation for the affected elevators:

- Elevators which are in motion shall proceed to the nearest available landing away from the fire floors. Upon arrival and stopping at landing, power operated doors shall open and remain open.
- Elevators which are standing at a landing with open doors shall remain open at that floor. If power-operated doors are closed, the system shall cause the doors to open.
- Shutdown shall occur only after the elevators are stopped at a landing, and power-operated doors are opened.
- Automatic shutdown shall override Phase I emergency recall operation, but shall not override Phase II emergency in-car operation per ASME A17.1, if Phase II operation is in effect.
- Actuation of the pit sprinkler shall NOT disconnect power to the elevator.

Fireman's Lift:

Firefighting or fireman's lift is an essential provision in all the high-rise buildings. The important requirements for design and installation of such a lift are:

1. Break-glass key switch (at G/F to control the lift);
2. Minimum duty load, say 630 kg (for firefighting equipment);
3. Minimum internal dimensions (m), 1.1(W) x 1.4(D) x 2.0(H);
4. An emergency hatch in the car roof;
5. Manufactured from non-combustible material;
6. A two-way intercom;
7. 1 hour fire-resisting doors of 0.8 m (W) x 2 m (H);
8. A maximum of 60 sec to run full building height;
9. Dual power supplies (normal + emergency).

ELEVATOR CONTROLLERS

Electromechanical switching is the oldest controller technology for elevator drive systems. Modern installations use microprocessor and relay logic controllers.

1. **Microprocessor:** Computer logic control is the standard for both electric traction and hydraulic elevators.
2. **Relay logic:** Mechanical electro-magnetic controller relays control the operation of the elevator.

Microprocessors are typical in most installations. However, if you have a base that is located in a remote location or subject to erratic building power supply, a relay logic controller may be the best choice.

ENVIRONMENTAL FACTORS:

The design shall consider the need to prevent or minimize environmental impacts, such as ground oil contamination and noise pollution.

1. Noise levels above 60 DBA should not be accepted outside of elevator machine rooms or inside of elevator cabs.
2. Oil leaks must be contained. In-ground pistons for hydraulic elevators should be protected by a sealed, schedule 80 PVC watertight cylinder with a water-stop ring embedded in the pit floor.

SECURITY CONSIDERATIONS:

These will be developed in conjunction with the user. In general, it is better to provide security access control independent of the elevator system. Security in an elevator system, if necessary, can be provided by conventional key lockouts or by card keys.

1. Conventional keys are least desirable because they are easily duplicated and usually require considerable time to insert and actuate, thereby slowing the operation of the elevator.
 2. Card keys shall be used. These should be applied in conjunction with a security computer so that the elevator system only passes the signal through and does not have to process it.
-

SECTION – 4 ELEVATOR CONTROL AND SAFETY FEATURES

The modern elevator control systems include a logic controller that takes the user's input and translates it into meaningful actions. The logic controller's central processing unit (CPU) must be given at least three critical pieces of information, namely:

- Where people want to go?
- Where each floor is?
- Where the elevator car is?

The first input "where people want to go" comes directly from the users and the elevator controls must interface with user's requests. In its simplest form when the users desire to ride the elevator they press a button located in the elevator lobby. The lobby is defined as the area of the building, adjacent to the elevator, on a given floor. The user presses the either of two buttons, up or down, correlating to the direction they want to move. The elevator logic controller receives the signal and responds by traveling via the path of predetermined travel routes or cycles. An elevator that is initially idle will dispatch immediately to the floor of the user request. The elevator will stop only for other requests for moving in its current direction of travel. Once all requests have been serviced in one direction of a cycle, the elevator will reverse and begin responding to requests in the same manner as before. An elevator that is idle for several minutes will return to the ground, or bottom, floor.

The second input "where each floor is" can often be determined by the addition of holes located on a long vertical tape inside the elevator shaft. The elevator car is equipped with a light or magnetic sensor that reads the number of and which holes are being passed by the elevator car as it ascends and descends. The elevator controller is equipped with a means of varying the motor's speed based on a set of feedback signals that indicate the car's position in the shaftway. As the car approaches its destination, a sensor near the landing, signals the controls to stop the car at floor level. Additional shaftway limit sensors are installed to monitor over travel & under travel.

The third input "where the elevator car is" related to the elevator scheduling operations. When a user presses the 'Up' or 'Down' button outside the elevator car, the elevator should begin moving towards them. Logic controllers must have some way to determine in what order riders should be picked up and dropped off. Many elevator systems will move in one direction (e.g., upward) and only pick up riders that are also signaling to go in that direction (e.g., upward).

When the final floor that has been requested in that direction (e.g., upward) is reached the elevator will turn around and pick up all riders signaling the opposite direction (e.g., downward). Of course, the elevator car also stops at all floors for which riders, already inside the car, have input a requested. A more sophisticated system, often used in hotels and other large buildings with a lot of foot traffic, involves the traffic patterns that reoccur. These systems have logic controllers that are programmed with information about the demand on each floor with respect to the time of day and they route the elevator cars accordingly so as to minimize the wait for all riders. When there are multiple elevator cars, the logic controller bases the movement on each car on that of the others. Often, the elevator car is equipped with a load sensor so that if the elevator is full to capacity it sends a signal to the control system and the logic controller signals the car not to pick up any more passengers until the load is lowered.

SIMPLEX CONTROLS

Many different types of systems may be applied to control elevators. All new elevators will be microprocessor-controlled. A single-car system is referred to as "simplex", a two-car system as "duplex", and a system having three or more cars as "group supervisory operation". There are a number of sub-systems such as independent service; attendant service; inspect service; fire service etc. that can be added to the main control system.

Independent service:

Independent service allows the elevator to be run from within the car without responding to hall calls. (In a bank of elevators, traffic would be rerouted to the other elevators, while in a single elevator; the hall buttons will be disabled). The elevator will remain parked on a floor with its doors open until a floor is selected and the door close button is held until the elevator starts to travel. Independent service is useful when transporting large goods or moving groups of people between certain floors. This service shall be included on all cars.

Attendant service:

Attendant service is activated from a key switch in the car. It allows an attendant in the car to control the opening and closing of the doors, the direction of travel, and whether to stop or bypass hall calls. When there is more than one car in a group, a car on attendant service is usually called by a separate, inconspicuous corridor push-button riser. Attendant service operation is frequently used for combined passenger/service applications.

Inspect service:

When an elevator is placed in inspect mode, the elevator will no longer respond to calls and comes immediately to a halt. In theory, this mode could be used as a way to stop the car in mid flight if one did not have a stop switch key. The elevator car will continue to remain idle until given a command from a corresponding access key switch. Key switches for access are usually located at the bottom floor and top floor. This enables the Elevator Mechanic to gain access to the pit of the elevator or the car top. Since this key allows entry into the hoist way of the elevator, this key is not given out and is restricted only for use by qualified elevator technicians.

Fire service:

Fire service is usually split up into two modes; 'phase-I' and 'phase-II'.

Phase-I mode is activated by smoke sensor or heat sensor in the building. Once the fire alarm is activated, the elevator will wait an amount of time, and then proceed to go into nudging mode to tell everyone the elevator is leaving the floor. Once the elevator has left the floor, depending on where the alarm was set off, the elevator will go to the Fire Recall Floor. However, if the alarm is activated on the fire recall floor, the elevator will have an alternate floor to recall to. When the elevator is recalled, it proceeds to the recall floor and stops with its doors open. The elevator will no longer respond to calls or move in direction.

Phase-II mode can only be activated by a key switch located inside the elevator, on the centralized control panel (CCP). This mode is created for firefighters so that they may rescue people from a burning building. The phase-II key switch located on the CCP has three positions: off, on, and hold. By turning phase-II on, you enable the car to move in direction. However, like independent service mode, the car will not respond to a car call unless you manually push and hold the door close button. Once the elevator gets to the desired floor, it will not open its doors unless you hold door open. This is in case the floor is burning and the firefighter can feel the heat and knows not to open the door. You must hold door open until the door is completely opened. For any reason the firefighter wishes to leave the elevator, they will use the hold position on the key switch to make sure the elevator remains at that floor. At anytime the firefighter wishes to return to the recall floor, they simply turn the key off and close the doors.

Group Supervisory Control System

Modern commercial buildings commonly have multiple elevators with a unified control system. The objective here is to minimize the average time any passenger spends from the time the

elevator call button is pushed to the arrival of the first available elevator. Different systems use different levels of sophistication. The simplest systems use a single up and down button on each floor regardless of the number of elevators. When a passenger calls for an elevator, the controller sends the nearest elevator that is traveling in the desired direction. The approach of an elevator car is signaled by an illuminated arrow above the elevators doors pointing up or down.

In more sophisticated systems, the controller monitors the elevator call system for a set, or bank, of elevators operating side by side. The operation zone of these elevators is divided into sectors, with each sector being made up of adjacent floors. When a car has answered a call and completed the designated run, it becomes available to answer another call. At this point, depending on the controller's programming, the car may be returned to a designated "home" floor, or may be sent to the sector furthest from other operating or available cars to cover that sector. When a call is received, the controller automatically compares the location of all the cars in the bank and sends the nearest one.

Controllers can also be programmed to respond differently at different times of the day. For example, the elevator controller in a busy office building will receive a preponderance of calls from the ground floor in the morning, when workers are arriving and need to go to their workplaces on the upper floors. In that case, the controller will be programmed to send all unassigned cars to the ground floor, rather than have them return to a home floor in their sector. Later in the day, a different set of instructions can be used to send unassigned elevators to different sectors, since passengers leaving the building will be much more evenly distributed among the floors than in the morning.

ELEVATOR SAFETY

A major attribute of an elevator system is safety and reliability. Lack of an effective safety system could lead to injury, or possibly death of users or maintenance personnel. The elevator system must be designed so as to protect riders with multiple backup systems for use in the event of failure of one or more than one critical mechanism. Today's elevator systems incorporate a wide variety of features designed to help reduce the chances of accidents and give passengers a quick, dependable ride. The basic features include:

Brakes

The most common elevator brake is made up of a compressive spring assembly, brake shoes with linings, and a solenoid assembly. When the solenoid is not energized, the spring forces the brake shoes to grip the brake drum and induce a braking torque. The magnet can exert a horizontal force for the break release. This can be done directly on one of the operating arms or through a linkage system. In either case, the result is the same. The break is pulled away from the shaft and the velocity of the elevator is resumed.

In order to improve the stopping ability, a material with a high coefficient of friction is used within the breaks, such as zinc bonded asbestos. A material with too high a coefficient of friction can result in a jerky motion of the car. This material must be chosen carefully.

Over-speed Safety Brake:

The safety brake, together with a speed-sensing governor, acts to stop an elevator, if it should over-speed in the down direction. If an elevator over-speeds, it opens a switch, which cuts off power to the drive motor and brake if the car travels at a preset over-speed in the down direction. Some types of governors will also open the governor switch and cut off power to the drive motor and brake if the car over-speeds in the up direction.

Safety Edge:

Older elevator systems use mechanical "safety edges" which cause the doors to stop or retract when they make contact with a person or object. This device is used with the component Photo Eye.

Photo Eye:

This device is mounted on the elevator doors and two light beams are used to detect any obstacles that may be in the doors opening. If the beam is interrupted the doors will not close and will automatically re-open if already closing. This device is used with Safety Edge.

Micro Light:

Modern elevator systems use a large number of invisible light rays to detect people or objects in the doorway and reverse or stop the doors without having to make physical contact. If one of these rays becomes interrupted the doors will not close or will not open automatically. Micro Light door protection system replaces both the Safety Edge and Photo Eye systems.

Door Operations:

When a user presses the Door Open or Door Close button, the door reacts as conditions permit. The amount of time for which the doors are held open is programmed into the logic controller. The elevator car doors also have a sensor that detects if someone or something is caught in the door and stops the door closing mechanism from closing the door with the large force that is required. This is also part of the safety system since it ensures that people are not hurt when trying to enter or exit the elevator car.

Other than sensors that detect passengers or objects in the door opening, door operators contain devices which limit the amount of closing force. Newer systems are better able to keep the closing force consistent even under unusual conditions such as the "stack effect" which can cause heavy air movement in elevator shafts.

Interlocks on the hoistway doors help assure that the elevator cannot leave a landing unless the doors are fully closed and secured. Should the doors be forced open, the interlock circuit will be broken, causing the elevator to immediately stop.

Various switches in the elevator shaft detect the presence of the car at certain stages of its journey. They initiate slowdowns and stops at the proper points, and help prevent over travel in the up or down direction.

To discourage the very dangerous practice of passengers trying to open the door of a stalled elevator, door restraints will restrict forcible movement of the door when the car is away from the floor. If the door is held open by the door protective devices or otherwise by the door open button for more than a predetermined time, it will sound a warning signal and close the doors at a reduced speed and torque. This is called "**Nudging**" - a system used with automatic door operation.

Hoistway Door Keyway:

This device allows access to the hoistway, if the elevator is not located at the landing. The emergency evacuation hatch on most elevators is designed to be opened only from the outside, by trained emergency personnel. This too is intended to help prevent any passenger from gaining access to the dangerous elevator shaftway.

Vent Slots:

These vents are equipped in the elevator to ensure that the air is evenly distributed throughout the car.

Passenger safety gadgets:

In the elevator cab you'll find several items to help increase safety. For example:

Door open and door close buttons to instruct the elevator to close immediately or remain open longer. In some elevators, holding the door open for too long will trigger an audible alarm (This alarm might confuse some people to think that the elevator is overloaded).

A stop switch (this is not allowed under British regulations) to halt the elevator (often used to hold an elevator open while freight is loaded). Keeping an elevator stopped for too long may trigger an alarm. Often, this will be a key switch.

An alarm button or switch – safety switch for passengers to signal that they have been trapped in the elevator.

Call buttons to choose a floor. Some of these may be key switches (to control access). In some elevators, certain floors are inaccessible unless one swipes a security card or enters a pass-code (or both). In the United States and other countries, call button text & icons are raised to allow blind users to operate the elevator; many have Braille text besides.

Control Philosophy during Power Black Out / Emergency power operation (EPR)

When power is lost in a **traction elevator** system, all elevators will initially come to a halt. One by one, each car in the group will return to the lobby floor, open its doors and shut down. People in the remaining elevators may see an indicator light or hear a voice announcement informing them that the elevator will return to the lobby shortly. Once all cars have successfully returned, the system will then automatically select one or more cars to be used for normal operations and these cars will return to service. The car(s) selected to run under emergency power can be manually overridden by a key or strip switch in the lobby. In order to help prevent entrapment, when the system detects that it is running low on power, it will bring the running cars to the lobby or nearest floor, open the doors and shut down.

In **hydraulic elevator** systems, emergency power will lower the elevators to the lowest landing and open the doors to allow passengers to exit. The doors then close after an adjustable time period and the car remains unusable until reset, usually by cycling the elevator main power switch. Typically, due to the high current draw when starting the pump motor, hydraulic elevators aren't run using standard emergency power systems. Buildings like hospitals and nursing homes usually size their emergency generators to accommodate this draw. However,

the increasing use of current limiting motor starters, commonly known as “Soft-Start” contactors, avoid much of this problem and the current draw of the pump motor is less of a limiting concern.

SOME MYTHS AND REALITIES ON ELEVATOR SAFETY

Myth: Many people believe elevators are held up by only one rope that can break, leaving passengers trapped in a falling car.

Truth: Elevators are supported by multiple steel cables. Each cable alone can support a fully loaded car.

Myth: Some people believe that an overcrowded elevator will fall.

Truth: This will not happen. An overloaded elevator will usually not move. The doors will stay open and a buzzer may ring until enough people get off the elevator to reduce the weight.

Myth: Some people believe they have been in an elevator where the elevator car fell several floors and then "caught itself".

Truth: This feeling is a mystery. Elevator experts believe people may think this happened because they 1) got on an elevator going in a different direction than expected, or 2) saw the elevator floor indicator lights flash by quickly which gave the visual impression of falling.

Myth: Some people believe the hall doors will open when an elevator is not there.

Truth: The truth is that the elevator car controls whether the hall doors open. If the car is not at the landing, the hall doors can't open because their opening can only be triggered by the arriving car engaging an unlocking device after the elevator has stopped at the landing.

Myth: Some people believe that if an elevator is stuck between floors that they are in danger of falling and should try to get out.

Truth: Absolutely not! Leaving the car on your own could result in injury. Elevator cars are designed as "safe rooms". The safest place is inside the car. Ring the alarm and wait for help. Leave the car only with the assistance of professional rescuers.

Myth: Pushing the CALL button repeatedly will make the elevator appear faster.

Truth: The call is registered just once; movement is in response to the elevator controllers.

Myth: Pushing the DOOR CLOSE button closes the doors faster.

Truth: It may cause the doors to close sooner, but not faster. However, if a buzzer sounds, the doors may close slower, it is important to get out of the doorway as quickly as possible.

SECTION – 5

TERMINOLOGY – DO'S & DON'T'S

- 1) **AC** - Alternating Current (a type of power for an elevator machine).
- 2) **Acceleration** - A period which the elevator moves at an ever increasing rate of speed, usually referring to that period from standstill to full speed.
- 3) **AC System** - A control system for an AC motor which has a single synchronous speed or two different synchronous speeds.
- 4) **ADA (Americans with Disabilities Act)** - The Americans with Disabilities Act of 1990 was signed into law by President Bush on July 26, 1990. The ADA is designed to give civil rights protection to people with disabilities, similar to those granted by the Civil Rights Act.
- 5) **Anchor bolts** - Bolt designed to fasten rail brackets, door sills, headers or other objects to beams or hoistway walls.
- 6) **Astragal** - Rubber molding on the leading edge of car and hoistway doors. It is furnished to quiet the operation of the doors as they reach their fully closed position.
- 7) **Babbitt** - A soft metal used to fill scratching of a plunger surface. It is also used to secure hoist ropes to shackles.
- 8) **Baked Enamel** - An enamel paint that must be baked to adhere to the surface.
- 9) **Balustrade** - The side of an escalator extending above the steps. It includes skirt panels, interior panels, decks and handrails.
- 10) **Bolster** - The bottom horizontal member of a hydraulic car sling, to which the platen plate attaches.
- 11) **Brace Rod** - A rod extending from the elevator platform framing to another part of the elevator car frame or sling for the purpose of supporting the platform or holding it securely in position. Brace rods are supports for the outer corners of the platform, each of which tie to upper portions of the stile.
- 12) **Brackets (Guide Rail)** - The steel plates, angles, or beams used to attach the rails firmly to the hoistway.
- 13) **Brake** - A spring loaded clamping device that prevents the elevator from moving when the car is at rest and no power is applied to the hoistway motor.

- 14) **Brake Drum** - A round, machined surface on the motor shaft which the brake clamps for stopping.
- 15) **Brake shoe** - Moving member(s) of a brake, lined with friction material which, when in contact with the brake drum, holds the elevator at floor level. On some types of control, it will stop the elevator when power is removed from the hoist motor.
- 16) **Building Type** - Required to determine the requirements for service. For example, an office building typically requires more elevators than an apartment building due to heavier loads & traffic. Elevator professionals often use building type to assist in recommending solutions based on different types of building traffic.
- 17) **Brush** - A device, usually of carbon or graphite composition, used to connect a circuit with the rotating or moving portion of a DC motor, generator or other electrical device. It carries current to and from the non-moving parts of connections.
- 18) **Buffer** - A device designed to stop a descending car or counterweight beyond its normal limit and to soften the force with which the elevator runs into the pit during an emergency.
- 19) **Buffer channel** - A channel in the pit floor of a traction elevator that supports buffers and guide rails.
- 20) **Buffer springs** - Large diameter springs that are permanently placed in a traction elevator pit for the purpose of stopping a descending car or counterweight beyond its normal limit of travel.
- 21) **Buffer stroke** - The distance that a buffer will compress.
- 22) **Cab** - The decorative room in which people ride in a passenger elevator.
- 23) **Cable (Rope)** - Usually 4 to 6 in number, it is used to support the car and (passing over the drive sheave to the counterweight) pull the car.
- 24) **Cable Wrap** - That amount of the drive sheave actually in contact
- 25) **Calculated Interval** - Measured in seconds, this is the time between elevator departures from the lobby during morning up peak. An interval of 30 seconds means that a car will be leaving the lobby every 30 seconds with a load of passengers. Traditional elevator theory can be used to show that the interval is equal to the calculated round trip time divided by the number of elevators.

- 26) **Calculated 5 Minute Handling Capacity** - The number of people that can be transported from the lobby in a five minute period, expressed as a percentage of the population. Elevator systems with a handling capacity of 12% can handle incoming passenger traffic up to a rate of 12% before lobby crowding occurs. Although traffic handling capacity guidelines have been debated for years, typically this measurement is an estimate of how many people arrive to use the elevators during the heaviest five minutes of morning rush hour.
- 27) **Callback** - In contract elevator service, a customer request which requires a check of an elevator other than the regularly scheduled maintenance.
- 28) **Call Cancellation** - The circuitry that clears a registered call using selector switching, hoistway switches, or moveable brushes or contacts.
- 29) **Capacity** - The load rating, measured in pounds, for which an elevator is designed and powered. The actual weight on the elevator should never exceed its rated capacity.
- 30) **Car (elevator)** - The load-carrying unit, including its platform, frame, enclosure, and car door or gate.
- 31) **Car call** - Indication of the passenger's destination floor as entered from the car operating station by pushing the corresponding floor push button.
- 32) **Car Operating Panel** - A panel mounted in the car containing the car operating controls, such as call register buttons, door open and close, alarm, emergency stop and whatever other buttons or key switches are required for operating.
- 33) **Car Operating Station** - A panel mounted in the car containing the car operating controls, such as call register buttons, door open and close, alarm emergency stop and whatever other buttons or key switches are required for operation.
- 34) **Car Riding Lantern** - A fixture mounted in the entry column, soffit or back wall which shows the direction of car travel.
- 35) **Car Top Inspection Station** - A control panel on top of an elevator car which, when activated, removes the car from normal service and allows the car to run at inspection speed from the car top station only.
- 36) **Center Opening Doors** - A door type, which consists of two horizontal sliding panels, which move in opposite directions.

- 37) **Clips, Rail** - Special clip designed to fasten guide rails to guide rail brackets; clamps rails firmly in place.
- 38) **Clutch** - A device mounted on the car door which pulls the hoistway doors as the car door moves open or closed.
- 39) **Code** - A system of regulations pertaining to the design, manufacture, installation and maintenance of elevators, dumbwaiters, escalators and moving walks. The most widely recognized and used is ANSI A-17.1 sponsored by the National Bureau of Standards, The American Institute of Architects, The American Society of Mechanical Engineers, and published by ASME. It has been adopted by many states. Some states and cities have written their own codes, most of which are based on the ANSI A-17.1. In California, the governing code is Title 8 and 24.
- 40) **Column** - The vertical sections of the car's entrance frame.
- 41) **Compensation** - Using ropes, chain or other design to counterbalance transfer of hoist rope weight from one side of the hoisting machine to the other as the car moves within the hoistway.
- 42) **Compensating chain** - Welded-link chain used to compensate the weight of hoist rope. One end of the chain attaches under the elevator and one end is fastened to the counterweight.
- 43) **Compensating rope** - Wire roping installed to obtain hoist rope weight compensation. Again, one end attached to the underside of the car and one end fastens to the counterweight.
- 44) **Compounding Sheave** - A pulley located on the car, and on the counterweight, under which the hoist cables run to double the capacity and reduce the speed of an elevator.
- 45) **Control Valve** - The device which on hydraulic elevators controls the oil flow to and from the jack.
- 46) **Controller** - An electrical panel which performs many computer functions by which it operates an elevator.
- 47) **Corner Post** - A method of mounting rails in opposite corners of the hoistway, usually to accommodate doors in adjacent hoistway walls
- 48) **Conventional Car Station** - A car-operating panel with a faceplate that is mounted in a fixed (non-swing) panel or sidewall.

- 49) **Corner Post** - A method of mounting rails in opposite corners of the hoistway, usually to accommodate doors in adjacent hoistway walls.
- 50) **Counterweight** - A weight which counterbalances the weight of an elevator car plus approximately 50% of the capacity load.
- 51) **Crosshead** - (1) The upper member of the car frame. (2) The traveling member of a selector.
- 52) **Cylinder** - The outermost lining of a hydraulic jack.
- 53) **DC** - Direct Current (a source of power for an elevator machine).
- 54) **Deceleration** - A period during which the elevator moves at an ever decreasing rate of speed, usually referring to that period from full speed to leveling speed.
- 55) **Deflector Sheave** - A pulley, aligned with the drive sheave, which provides a path for the cables to drop straight to the counterweight.
- 56) **Direct Current (DC)** - An electric current flowing in one direction only and substantially constant in value.
- 57) **Dispatch Control System** - A system that controls two or more elevators by governing assignments in response to hall calls. Also controls zoning, peak traffic demands and parking.
- 58) **Door Gibs** - Devices at the bottom of horizontal sliding door panels, which stick into sill grooves and eliminate door panels swinging in or out.
- 59) **Door Hanger** - A rolling assembly fastened to the top of a door panel which supports and allows horizontal sliding movement of the door panel. The door track on which the hanger rolls is part of the door hanger assembly.
- 60) **Door Lock** - Any type of mechanical lock designed to prevent the opening of a hoistway door from the landing side.
- 61) **Door Open Time** - Length of time doors stand open after reaching full open position, until doors start to close provided no signal is received to shorten door time.
- 62) **Door Operator** - A motor-driven device mounted on the car which opens and closes the car doors.
- 63) **Door Panel** - A portion of the door or gate, which covers the opening and moves to uncover the opening.

- 64) **Door Protective Device** - Any type of device used with automatic power operated doors that detects obstructions to the normal closing of the elevator doors and either causes the doors to reopen or go into some other mode of operation, such as nudging. A safe edge, a safety astragal, a photoelectric device (safe ray), and electrostatic field device are examples of door protective devices.
- 65) **Door Sill** - The threshold of a door opening with grooves to guide the bottom of the car door.
- 66) **Door Track** - A rail which accepts the rolling assembly of the door hanger and allows the horizontal movement required to open and close the doors. The door track is a part of the door hanger assembly.
- 67) **Dot Matrix Position Indicator** - Position indicator with a display that uses small light emitting diodes (LED) to display a character.
- 68) **Drip Ring** - A flange on the guide used to collect oil from the plunger so it can drain into a container.
- 69) **Drive** - The pulley or wheel, grooved for each hoist cable, which drives the elevator up or down.
- 70) **Drive Machine** - The power unit which applies the energy necessary to raise and lower an elevator, material lift, or dumb waiter car or to drive an escalator, an inclined lift or a moving walk.
- 71) **Drive Sheave** - The grooved wheel of a traction-type hoisting machine over which the hoist ropes pass, and by which motion is imparted to the car and counterweight by the hoist ropes.
- 72) **Dust covers (hanger cover)** - Sheet metal cover that protects the door hanger track assembly.
- 73) **Double-wrapped** - Roping arrangement on (gearless) traction elevators, where the hoist ropes pass around a secondary sheave and back over the drive sheave again, so the traction (friction) of the ropes on the drive sheave is increased
- 74) **Electric Eye** - A light beam (or beams), which spans a door opening and, when interrupted, causes the door to reopen.

- 75) **Emergency exit** - The removable opening in the car top panel of the cab. Removable only from the top of the car, the emergency exit permits passengers to be evacuated from the elevator during emergency.
- 76) **Emergency Stop Switch** - A hand-operated switch in the car push button station which, when thrown to the off position, stops the elevator and prohibits its running.
- 77) **Enclosure** - The ruggedly built room on a freight elevator in which the material being carried is located.
- 78) **Encoder** - A device used to convert an analog signal into digital information.
- 79) **End Post** - A method of mounting the two stacks of rails on a common wall at the end of the hoistway.
- 80) **Escalator** - A power-driven, inclined, continuous stairway used for raising or lowering passengers.
- 81) **Faceplate** - The decorative cover which houses control devices such as position indicators, pushbuttons, key switches, etc.
- 82) **Fascia** - Steel plate installed in the hoistway vertically to extend from the top of the hoistway door hanger header to the sill at the landing above, which connects the hoistway door hanger to the sill to prevent pinch points and ledges.
- 83) **Feedback** - The transmission of current or voltage from the output of a circuit or device back to the input, where it interacts with the input signal to modify the operation of the circuit or device.
- 84) **Firefighter's Service** - A device or group of devices which provide (1) a signal for immediate recall to a designated landing in order to remove cars from normal use, and (2) to permit special operation for firefighters or other authorized emergency personnel.
- 85) **Fishplate** - A steel plate, which spans the joint where two lengths of guide rails in a stack meet.
- 86) **Floor Selector** - A mechanical, electrical, or microprocessor driven device which initiates and/or controls some or all of these functions: establish direction of travel, acceleration, deceleration, leveling, stopping, call cancellation, door operation, position indicators, and hall lanterns for an individual elevator.
- 87) **FPM** - Feet per minute.

- 88) **Freight Elevator** - An elevator used to carry material rather than people and provided with vertical bi-parting doors.
- 89) **Full Speed** - The contract speed at which the elevator should run.
- 90) **Gates (Double Blade Gate)** - A vertical sliding, counterweighted device used to provide entrance protection on freight elevators. It consists of two panels usually made of expanded metal. The blades telescope to reduce overhead space requirements.
- 91) **Gear** - A toothed wheel designed to mesh or engage with another wheel or part for transmitting or changing motion.
- 92) **Geared Traction Machine** - A traction machine in which the power from the motor is transmitted to the drive sheave through reduction gears.
- 93) **Gearless Traction Machine** - A type of elevator hoisting machine on which the hoist ropes pass over a traction drive sheave, which is an integral part of the armature. Called gearless because no geared reduction unit is utilized.
- 94) **Generator** - An electromechanical device that converts mechanical energy to electrical energy (usually direct current).
- 95) **Governor** - (1) A mechanical speed control mechanism. For elevator, it is a wire rope driven centrifugal device used to stop and hold the movement of its driving rope. This initiates the activation of the car safety device. It opens a switch, which cuts off power to the drive motor and brake if the car travels at a preset overspeed in the down direction. Some types of governors will also open the governor switch and cut off power to the drive motor and brake if the car overspeeds in the up direction.
- 96) **Governor Rope** - A wire rope attached to an elevator car frame that drives the governor and, when stopped by the governor, initiates setting of the car safety.
- 97) **Groove - "Vee"** - A groove in the drive sheave which produces a pinching or wedging effect on the cable, used on gearless machines.
- 98) **Groove – "U"** - A groove in the drive sheave, which relies on friction between groove and cable, used on gearless machines.
- 99) **Gross load** - The combined weight of the platform, sling, cab, and rated capacity.
- 100) **Group operation** - Scanning a system of two or more cars for hall calls then dispatching cars appropriately based on calculated estimated time of arrival.

- 101) **Guide** - An assembly, bolted to the upper end of the cylinder, which centers the plunger in the cylinder.
- 102) **Guide Rails** - Steel T-, round, or formed sections with guiding surfaces installed vertically in a hoistway to guide and direct the course of travel of an elevator car and elevator counterweights.
- 103) **Guide Rollers** - Guide shoes with rollers which rotate on the guide rails.
- 104) **Guide Shoes** - (1) Devices used mainly to guide the car and counterweight along the path of the guide rails. They also assure that the lateral motion of the car and counterweight is kept at a minimum as they travel along the guide rails. (2) Guiding projections mounted on the bottom edge of horizontally sliding doors or gates, or on the sides of vertically sliding doors or gates to guide them.
- 105) **Group Supervisory Control System** - A system that controls two or more elevators by governing assignments in response to hall calls. Also controls zoning, peak traffic demands and parking.
- 106) **Hall Call** - A call registered at a landing button or fixture.
- 107) **Hall Lantern** - A corridor mounted signal light indicating that an elevator car is approaching that landing and the direction in which the car is to travel.
- 108) **Hall Station** - Device located in hall usually near the elevator to be used when calling the elevator to that floor.
- 109) **Handling Capacity** - The number of people that can be transported from the lobby in a five minute period, expressed as a percentage of the population. Elevator systems with a handling capacity of 12% can handle incoming passenger traffic up to a rate of 12% before lobby crowding occurs. Although traffic handling capacity guidelines have been debated for years, typically this measurement is an estimate of how many people arrive to use the elevators during the heaviest five minutes of morning rush hour.
- 110) **Handrail** - (1) The moving handhold provided for escalator passengers, which moves over the top of the balustrade and newels. (2) A railing serving as a support.
- 111) **Handrail Guard** - A guard, usually made of rubber, that fits over the outside of the handrail at a point where the handrail enters or leaves the balustrade. It is designed to keep a person's fingers out of the handrail opening.

- 112) **Hanger Rollers** - Rollers (two per panel) from which horizontal door panels are suspended.
- 113) **Hitch Plate** - A plate (on traction elevators) clamped to the underside of the crosshead and to which the shackles are attached.
- 114) **Hoist Rope** - The wire ropes used to raise and lower an elevator car.
- 115) **Hoistway** - The space enclosed by fireproof walls and hoistway doors in which the elevator travels, extending from the pit floor to the roof. (Hoistway is sometimes called "hatchway" or "hatch".)
- 116) **Hoistway Access** - An option which allows access to the hoistway from the lowest and uppermost landing through a spring return key switch at each access landing. Depressing the key switch moves the car up and down the hoistway at leveling speed and enables access to the top of the car or the pit.
- 117) **Hoistway Door** - The side of the elevator door visible in the lobby or hallway which may be opened only when the car is at that landing and the door operator engages both the hoistway and the car doors.
- 118) **Hydraulic** - One of two methods by which an elevator is moved, whereby the elevator is "pushed" up by oil.
- 119) **Hydraulic Elevator** - A power elevator where the energy is applied, by means of a liquid under pressure, in a cylinder equipped with a plunger or piston.
- 120) **Hydraulic Valve** - In the construction of hydraulic elevators, a valve used to regulate the flow of the fluid used to raise and lower the elevator, usually a low viscosity oil.
- 121) **Independent service** - When activated through a key switch, the car is removed from group operation and will bypass all landing calls, deactivate hall/car riding lanterns, and respond only to car calls. Also known as hospital emergency operation.
- 122) **Interlock** - A device having two related and interdependent functions which are:
- To prevent the operation of the driving machine by the normal operating device unless the hoistway door is locked in the closed position. An electro-mechanical device that prevents operation of an elevator unless the hoistway doors are in the closed and locked position;

- To prevent opening of a hoistway door from the landing side unless the elevator is in the landing zone and is either stopped or being stopped.

123) **Intermediate Landing** - Any landing served by an elevator between its upper and lower terminal landings.

124) **Interval** - The time (in seconds) between elevator departures from the lobby during morning up peak. An interval of 30 seconds means that a car will be leaving the lobby every 30 seconds with a load of passengers. Traditional Elevatoring theory can be used to show that the interval is equal to the calculated round trip time divided by the number of elevators.

125) **“In Use” lights** - Signal on freight elevators used to indicate that the elevator is either running or has the doors open. This is only used on freight elevators with manual bi-parting doors.

126) **Isolated platform** - Car platform that is mounted on rubber vibration absorbing material to reduce the transmission of noise and vibration. Isolated platforms are not applicable to holeless or telescoping jacks.

127) **Induction Motor** - An AC motor having two parts: a rotor and a stator. The stator creates a rotating magnetic field that induces a voltage into the rotor causing it to rotate.

128) **Jack** - The device which pushes the hydraulic elevator.

129) **Jamb** - Any one of the three members constituting an elevator entrance frame: head jamb, strike jamb and return jamb.

130) **Junction box** - Box with a cover that serves the purpose of joining different runs of cables and providing space for the connection of conductors.

131) **Landing** - That portion of a floor, balcony, or platform used to receive and discharge passengers or freight.

132) **Landing Door** - The movable door at the entrance of an elevator which provides access to the hoistway.

133) **Landing Zone** - A zone extending from a point 18” below an elevator or material lift landing to a point 18” above the landing.

- 134) **Layout** - A scaled mechanical drawing showing dimensioned plan views and elevations of an elevator hoistway and machine room to indicate space conditions, pertinent dimensions, sizes and location of components of the installation.
- 135) **Leveling** - The movement of an elevator toward the landing sill when it is within the leveling zone. When the word leveling is used, the inference is that the process of attaining a level stop or position (the platform level with the landing sill) is performed completely automatically.
- 136) **Leveling Zone** - The limited distance above or below an elevator or material lift landing within which the leveling device is permitted to cause movement of the car toward the landing.
- 137) **Limited Access Features**
- Car Call Lockout – a feature which allows the user to prevent car calls from being registered at specific floors. Car calls are typically locked out by using keyswitches, card readers, key pads and computer-based monitoring systems.
 - Hall Call Lockout – a feature which allows the user to prevent hall calls from being registered at specific floors. Hall calls are typically locked out by using keyswitches, card readers, key pads and computer-based monitoring systems.
- 138) **Load** - Capacity rating in pounds which an elevator is designed to safely handle.
- 139) **Lobby Floor Height** - The main lobby is often taller than other floors. Lobby height should be entered separately as the distance from the top of the lobby's finished floor to the top of the finished floor of the next landing. Small express zones may be accommodated by using the distance from the lobby to the next landing served by the elevator. For example, if the cars do not stop at floors 2 and 3, then you may enter a lobby height of 42 feet (18' for lobby and 12' for each of floors 2 and 3).
- 140) **Lubricator** - A device, which feeds oil to the rail and provides lubrication for sliding shoes.
- 141) **Machine Room** - The space in which the driving machine for an elevator or group of elevators, dumbwaiter, escalator or group of escalators is located.
- 142) **Main (Car) Guide Rails** - Steel T-sections with machined guarding surfaces installed vertically in a hoistway to guide and direct the course of travel of an elevator car.

- 143) **Max Car Loading** - The percentage of total capacity that the car carries on each round trip. Even though the nameplate on a 3500 pound car lists the capacity as 21 persons, it is very unusual that 21 people will crowd into the car. This averages about 80% but can vary depending upon tenant behavior and culture.
- 144) **Motor Control** - That portion of a control system that governs the acceleration, speed, retardation, and stopping of the moving elevator.
- 145) **Net Travel** - The distance from the top to the bottom floor.
- 146) **Nudging** - A system used with automatic door operation which, if the door is held open by the door protective devices or the door open button for more than a predetermined time, will sound a warning signal and close the doors at a reduced speed and torque.
- 147) **Number of Elevators** - The number of elevators necessary to meet your requirements. This number is derived from a traditional traffic calculation during morning up peak. In this scenario, an elevator loads at the lobby, delivers passengers to their floors, and returns empty for the next trip. Request a full simulation to analyze more complicated situations where a group of cars controlled by specific dispatcher logic serves lunchtime or down peak passenger traffic.
- 148) **Number of Openings** - Most elevators feature doors on one side of the car. Some applications will require two sets of doors - front and rear doors. On floors where both sets of doors open, the time the car remains at that floor is diminished since passengers may disembark more rapidly.
- 149) **Oil Buffer** - One type of buffer (for elevators with speeds of more than 200 feet per minute), which uses a combination of oil and spring to cushion the elevator. It is located in the elevator pit.
- 150) **Oil Line** - The pipe that channels the oil from the power unit to the jack.
- 151) **One to One roping (1:1)** - Arrangement of elevator hoist ropes in which one end of each hoist rope passes from the car hitch over the machine sheaves to the counterweight hitch. With 1:1 roping, the car, counterweights, and hoist ropes all travel at the same speed.
- 152) **Opening** - The clear passageway into an elevator
- 153) **Overhead** - The upper portion of the elevator hoistway. Overhead is determined by the elevator application.

- 154) **Overhead machine** - Standard machine room location on a traction elevator, the machine room is located above the elevator hoistway
- 155) **Over Travel** - A short distance beyond the terminal floor as allowance for building inaccuracies, manufacturing or installation inaccuracies.
- 156) **Overspeed Governor Switch** - A part of an escalator machine. It is actuated by centrifugal force and trips a switch when the motor speed has increased 20 percent over its rated nameplate speed.
- 157) **Packing Gland** - (1) The substance, usually of elastic or flexible material formed in rings used in the stuffing box of the worm shaft of a geared machine or of a hydraulic elevator to prevent excessive leakage. (2) Strips or blocks of material used for shimming.
- 158) **Parking** - A feature incorporated into the signal system of an elevator or elevators by which an elevator receives a signal to always return to a preselected landing after all its car or landing signals have been answered and canceled.
- 159) **Passenger Elevator** - An elevator used to carry people and provided with horizontal sliding doors.
- 160) **Peak** - In a waveform or other changing parameter, a peak is an instantaneous or local maximum or minimum.
- 161) **Penthouse** - The machine room above the hoistway on traction elevators.
- 162) **Pickup Rollers** - Devices on the hoistway door which mate with the clutch on the car door to allow the hoistway doors to be pulled open and closed.
- 163) **Pit** - That portion of the hoistway extending from the sill level of the lowest landing to the floor at the bottom of the hoistway.
- 164) **Pit Channels** - Steel channels on the pit floor to anchor the guide rails and other pit-mounted devices.
- 165) **Platen** - A plate, used to attach the jack to the bolster.
- 166) **Platform** - The entire floor assembly of an elevator on which passengers stand or the load is carried.
- 167) **Plunger** - The inside moveable part of a hydraulic jack that attaches to an elevator car frame on direct drive application or drive sheave on a cabled hydraulic system.

- 168) **Position Indicator** - A device that indicates the position of the elevator car in the hoistway. It is called a hall position indicator when placed at a landing, or car position indicator when placed in the car.
- 169) **Power Unit** - That device on hydraulic elevators which supplies the motive force to run the car.
- 170) **Pump** - That device which draws oil from the tank and pushes it through the oil line to the jack to move the elevator up.
- 171) **Push Button Station** - A decorative device containing one or more hand-operated devices (buttons or switches) by which the passenger tells the controller what action is desired.
- 172) **Rail Clips** - Devices bolted to guide rail brackets to clamp rails firmly in place.
- 173) **Rated speed** - The elevator speed in the up direction with the rated load in the car.
- 174) **Registered call** - A signal initiated by pressing a car or landing pushbutton, indicating a demand for service at or to the landing for which the button was pressed.
- 175) **Relay** - An electric device that is designed to interpret input conditions in a prescribed manner and after specified conditions are met, to respond and cause contact operation or create change in associated electric control circuits.
- 176) **Retardation** - The operation of reducing the elevator drive motor speed from normal operating speed to stop. Also referred to as Deceleration.
- 177) **Revolutions Per Minute (RPM)** - The number of completed turns per minute that an object revolves around its axis.
- 178) **Ring** - A large gear, which is attached to the drive sheave.
- 179) **Rise** - Vertical distance from the finished floor level of the terminal landing to the finished floor of the top landing. See also: Travel
- 180) **Riser** - A series of hall stations for an elevator or group of elevators
- 181) **Roller Guides** - Guide shoes which use rollers that rotate on guide rails rather than sliding on the rails.
- 182) **Ropes (Hoist)** - For traction elevators, a strong cord of twisted fibers such as steel which connects the elevator car sling assembly and the counterweight passing over or around the drive sheave. The ropes are used to raise and lower an elevator.

- 183) **Rotor** - The rotating element of an AC induction motor.
- 184) **Safe Edge** - A mechanical door protective and automatic door reopening device, used with automatic power door operators. It is arranged so that in the event the door either approaches or meets an obstruction when closing, the safe edge will actuate an edge safety switch that will automatically cause the doors to stop and reopen. It is vertically mounted to extend from the bottom to the top of a horizontally sliding panel and projects forward of the leading edge of the panel.
- 185) **Safe Ray** - A photoelectric door protective and automatic door reopening device for automatic power door operators. It consists of a photoelectric receiving unit and light source device arranged to project a light ray across the elevator door entrance. The interruption of the light ray will cause the doors to remain open as long as the ray is interrupted, or cause the reversal and reopening of doors that are closing.
- 186) **Safety** - A large clamp that anchors the car to the building to keep the elevator from falling.
- 187) **Safety Astragal** - A resilient, non-crushing member installed on the bottom of the upper section of a biparting freight elevator hoistway door.
- 188) **Safety Plank** - The bottom member of a sling for a traction elevator, which contains the safety.
- 189) **Seal** - A device mounted on the guide to minimize oil escaping around the plunger.
- 190) **Secondary Sheave** - A pulley on a gearless machine which serves two purposes: (1) To allow each cable to second pass over the drive sheave and (2) To deflect the cable for a straight drop to the counterweight.
- 191) **Selector** - An electrical device, driven by the elevator, which simulates elevator movements.
- 192) **Setting the Safety** - The act of triggering the safety to stop the elevator from falling.
- 193) **Shackle** - Threaded rods to which the hoist cables are socketed and which bolt to the hitch plate and the counterweight.
- 194) **Shaft** - That part of a rotor that carries other rotating members and that is supported by bearings.
- 195) **Sheave** - A wheel mounted in bearings and having one or more grooves over which a rope or ropes may pass.

- 196) **Shim** - A piece of metal or other material used to fill out a space.
- 197) **Side Post** - The normal practice of mounting rails on opposite hoistway walls midways, front-to-back.
- 198) **Sill** - The bottom horizontal member of an entrance which provides the foundation and footing for the entrance frame. The sill extends the full width of the door travel.
- 199) **Single Blade Gate** - A vertical sliding, counterweighted device used to provide entrance protection on freight elevators and consisting of one panel, usually made of expanded metal.
- 200) **Single Speed AC** - A type of traction machine powered by an AC-driven motor of one fixed speed.
- 201) **Single Speed Door** - A type of door consisting of one horizontal sliding panel.
- 202) **Sling** - The basic structural frame, which consists of two stiles, a crosshead and a bolster or safety plant, which supports the platform and cab of an elevator.
- 203) **Soffit** - The top horizontal piece of the entrance, which is the underside of the transom.
- 204) **Specifications** - A detailed itemized description of the plans, materials, dimensions and all other requirements proposed for the installation of the equipment.
- 205) **Spring Buffer** - One type of buffer, for elevators with speeds less than 200 feet per minute, which cushions the elevator. It is located in the elevator pit.
- 206) **Stack** - An accurate, vertical line of rails located in the hoistway. "Stack" may also be used when referring to conduit and electric wiring.
- 207) **Stator** - The non-rotating part of the magnetic structure in an induction motor.
- 208) **Step** - The moving platform on which an escalator passenger rides.
- 209) **Stile** - The vertical member of the sling, one for each side.
- 210) **Stopping** - The action of final motion of the elevator from leveling speed to an accurate floor level.
- 211) **Strike Column** - Column located inside the car, which extends the full height of the elevator door opening. This is the column against which the sliding door closes.
- 212) **Stuffing Box** - The part of a machine or cylinder in which seals or packing is installed to prevent leakage.

- 213) **Swing Return Panel** - A car-operating panel that extends the full height of the car entrance.
- 214) **Tachometer** - A device which measures the revolutions per minute of a revolving shaft. To tach means to measure speed with a tachometer.
- 215) **Tank (Reservoir)** - A container to store the oil used to move the elevator.
- 216) **Thrust Bearing** - A bearing designed to withstand an axial load placed on a shaft such as that imposed by a worm and worm gear.
- 217) **Top-of-car Inspection Station** - Controls on the top of the car used by an elevator constructor to operate the car at inspection speed. It provides a means of operating an elevator from on top of the car at slow speed during adjustment, inspection, maintenance and repair.
- 218) **Torque** - (1) A force that produces or tends to produce rotation or torsion. The pressure, measured in foot pounds, exerted by a rotating shaft. (2) The turning power of a motor. (3) The turning effort a brake is designed to stop.
- 219) **Traction Machine** - An electric machine in which the friction between the hoist ropes and the machine sheave is used to move the elevator car with the cable.
- 220) **Traction** - One of two methods by which the elevator is moved, whereby the elevator is "pulled" up by cables.
- 221) **Traveling Cable** - A cable made up of electric conductors, which provides electrical connection between an elevator or dumbwaiter car, or material lift, and a fixed outlet in the hoistway or machine room.
- 222) **Two Speed AC** - A type of traction machine powered by an AC-driven motor (actually 2 motors built into one), which has 2 distinct speeds.
- 223) **Two Speed Door** - A type of door consisting of two horizontal sliding panels, which move, in the same direction.
- 224) **Two to One Roping (2:1)** - Arrangement of hoist ropes in which one end of each hoist rope passes from a dead-end hitch in the overhead, under a car sheave, up over the drive sheave, down around a counterweight sheave and up to another dead-end hitch in the overhead. The car speed is one-half the rope speed.

- 225) **Variable Voltage** - A method of controlling a DC-driven machine, which produces many different speeds.
- 226) **Variable Voltage, Variable Frequency (VVVF)** - A method of controlling an AC motor to vary the torque and speed by varying voltage amplitude and frequency.
- 227) **Valve** - A hydraulic elevator mechanism that regulates the motion of the elevator by regulating the flow of oil.
- 228) **Vertical transportation** - The class of transport for moving people or equipment in the vertical direction.
- 229) **V-Groove** - A groove in the drive sheave which produces a pinching or wedging effect on the cable, used on geared machines.
- 230) **Wainscoting** - Walls extending from the platform to the handrail or in some cases to the underside of the car top. Typically referred to as the finish of walls in a freight elevator.
- 231) **Worm** - A shaft on which a spiral groove is cut.
- 232) **Worm Gear** - The gear wheel which engages the revolving worm. The rotating motion of the worm is transmitted through the worm gear to the drive sheave.
- 233) **Zoning** - The procedure which involves parking designated elevators to serve a specified floor or group of floors.

GENERAL GOOD PRACTICES - DO'S and DONT'S

DO'S

LOCATE ELEVATORS IN THE HOISTWAY IN THE SERVICE CORE AND SET PASSENGER ELEVATORS BACK 600mm (2 ft) FROM CORRIDOR LINE

LOCATE SERVICE ELEVATORS IN THE HOISTWAY IN THE SERVICE CORE AND SET SERVICE ELEVATORS BACK 1800mm (6 ft) FROM CORRIDOR LINE

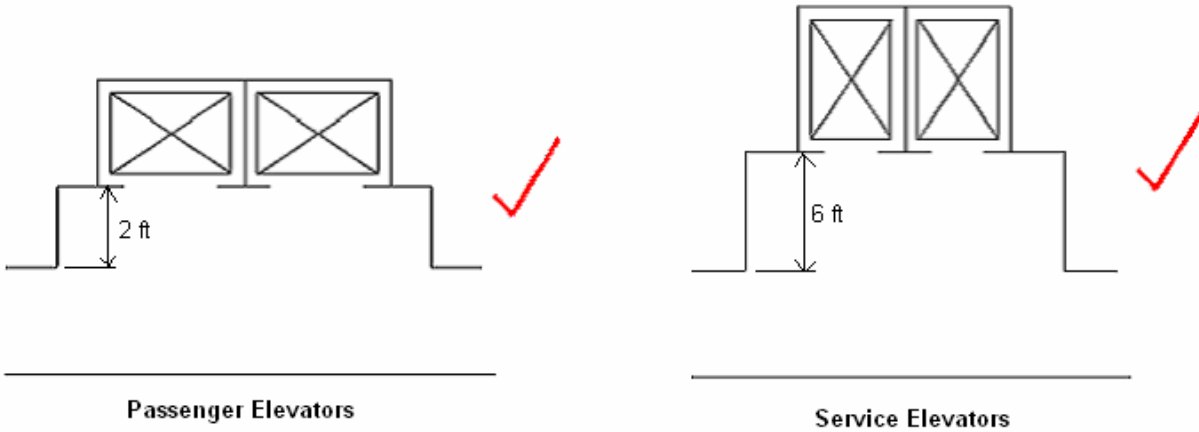

PROVIDE POSITIVE SEPARATION OF PASSENGER & SERVICE TRAFFIC

PROVIDE 4.2 m (14 ft) MIN WIDTH SERVICE ELEVATOR LOBBIES

PROVIDE 3.6 m (12 ft) MIN WIDTH PASSENGER ELEVATOR LOBBIES

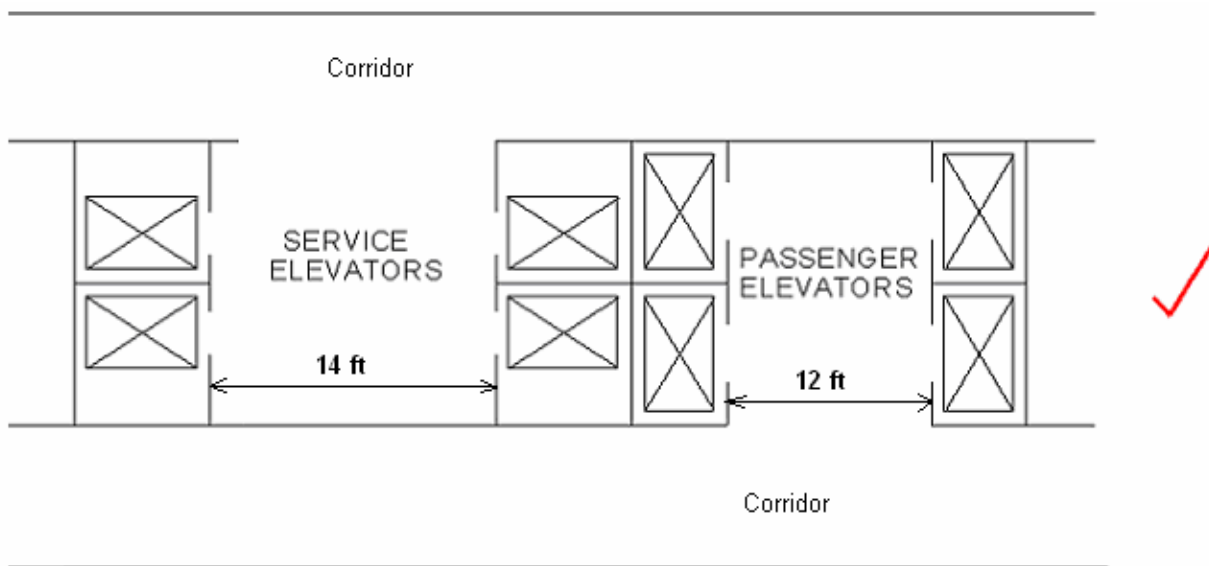

PROVIDE STAIRS ADJACENT TO PASSENGER & SERVICE ELEVATOR LOBBIES

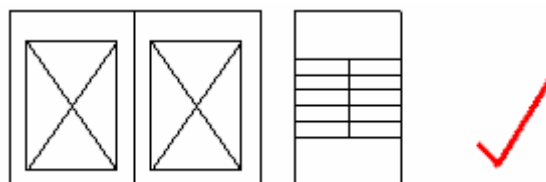

DONT'S

DO NOT PLACE 4 OR MORE ELEVATORS IN A STRAIGHT LINE

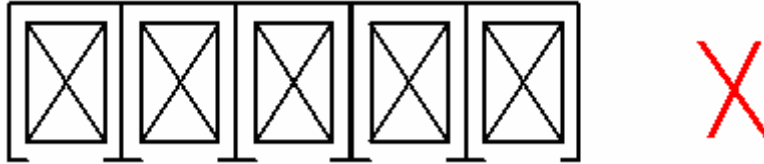

DO NOT MIX DIFFERENT TYPES OF ELEVATORS IN SAME CORE AREA

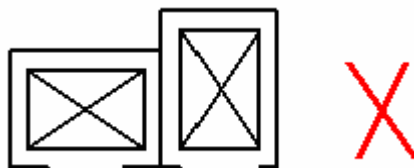

DO NOT PLACE ELEVATOR OPENINGS ON A COMMON CORRIDOR LINE

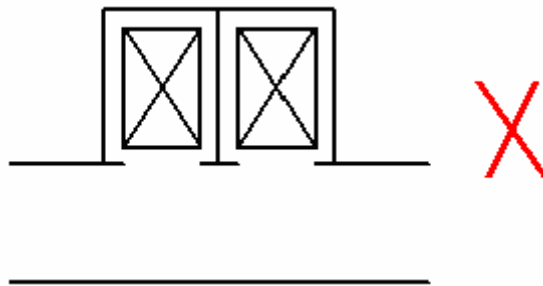

DO NOT LOCATE ELEVATOR LOBBIES ON MAIN THOROUGHFARE CORE

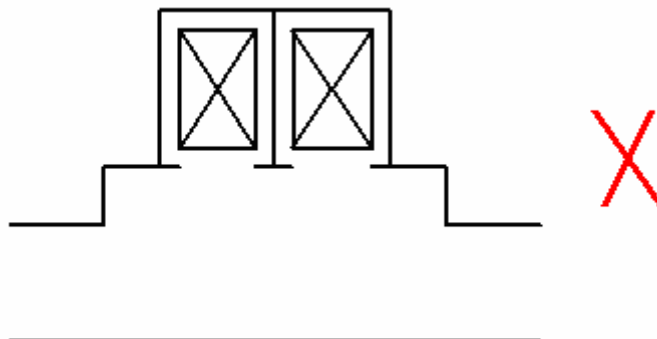

DO NOT LOCATE DEDICATED SERVICE/FREIGHT ELEVATOR WITH PUBLIC USE ELEVATORS

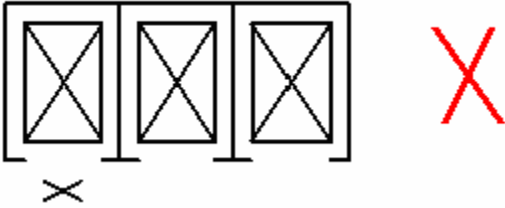

DO NOT DESIGN ELEVATORS WITH FRONT AND SIDE OPENINGS

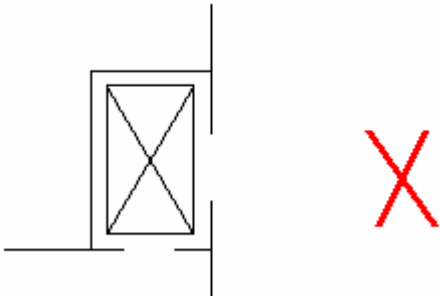

DO NOT LOCATE ELEVATORS OVER OCCUPIED AREAS & DO NOT EXCEED 12 meters (40 ft) OF TRAVEL FOR HYDRAULIC ELEVATORS

